

PATIO LOUNGE CHAIR  
(2 PCS)  
**ASSEMBLY MANUAL**

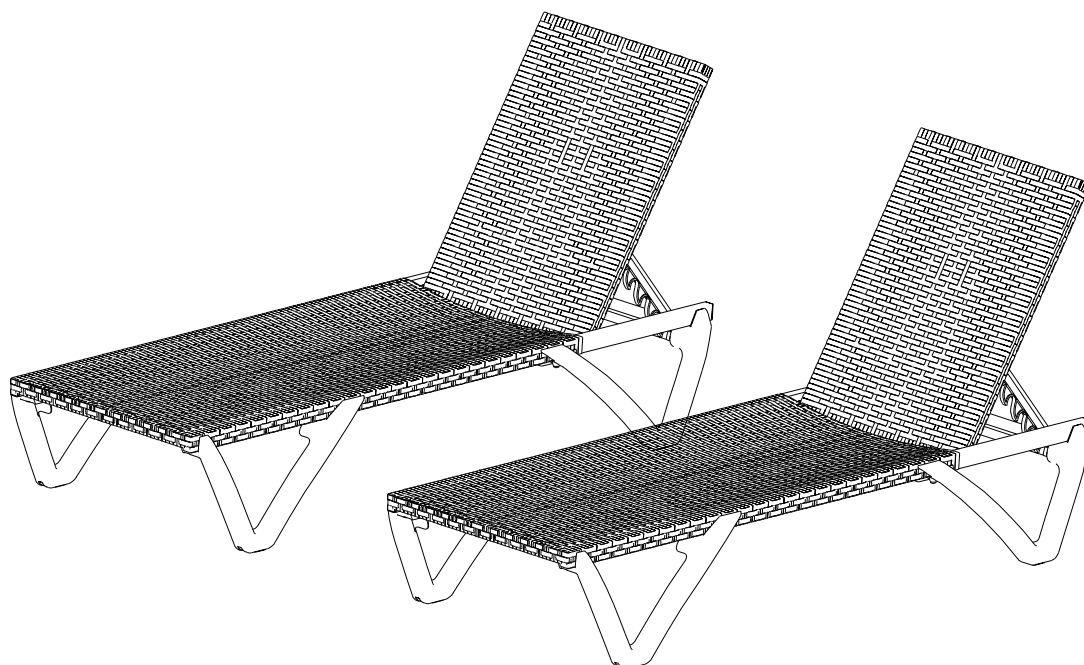

# WARNING AND CAUTIONS

Before starting assembly:

- Read all instructions thoroughly.  
Open and check boxes for parts listed.
- If any parts are broken or missing call or email customer service.
- Keep all packaging until you are satisfied with your product.
- Returns are not accepted without original packaging.
- Make sure you have ample space for assembly.

WARNING:

- DO NOT strain yourself. Some items are easier to assemble with the help of another person.
- DO NOT force bolts or nuts. If a bolt becomes stuck, unscrew it and start again.
- DO NOT assemble on an uneven surface to prevent any damage and to ensure proper assembly.

Important:

- **DO NOT fully tighten all screws until assembly is complete.**

**(A) 2X Main Seat Frame**

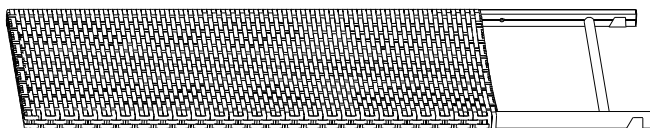

**(B) 2X Front leg**

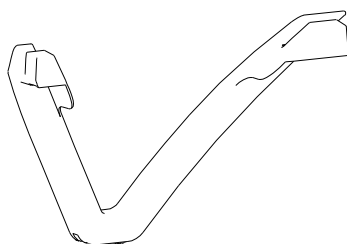

**(C) 2X Front leg**

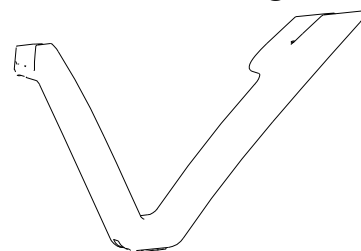

**(D) 2X Back leg**

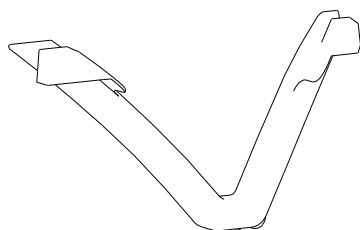

**(E) 2X Back leg**

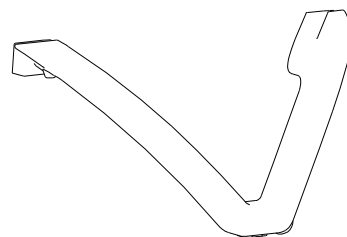

**(F) 2X Back**

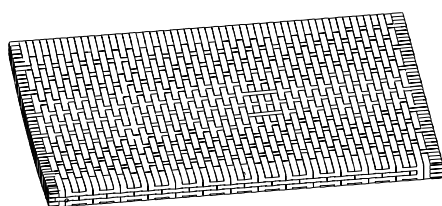

**(G) 2X Adjustment Tube**

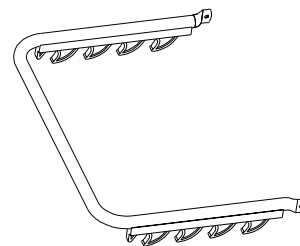

1. Please assemble the lounge chair on the carton or carpet to avoid scratch.

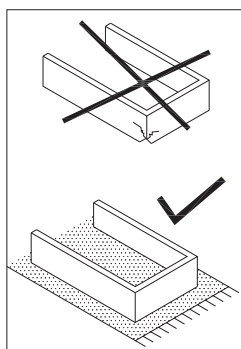

**(K) 28X Bolt M6X35**



**(M) 4X Bolt M6X25**

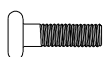

**(L) 4X Plastic Cylinder**



**(P) 1X Allen Wrench**

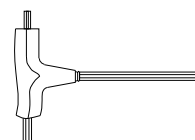

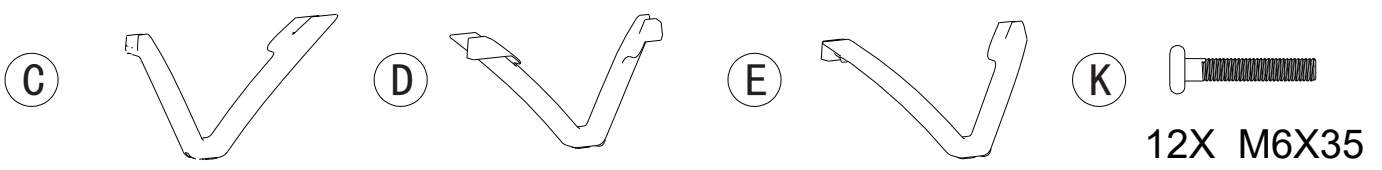
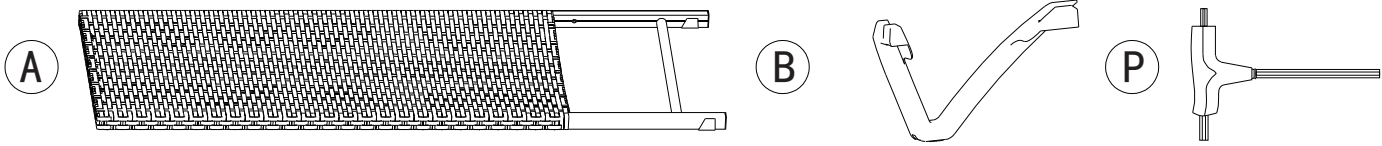

Step 1:

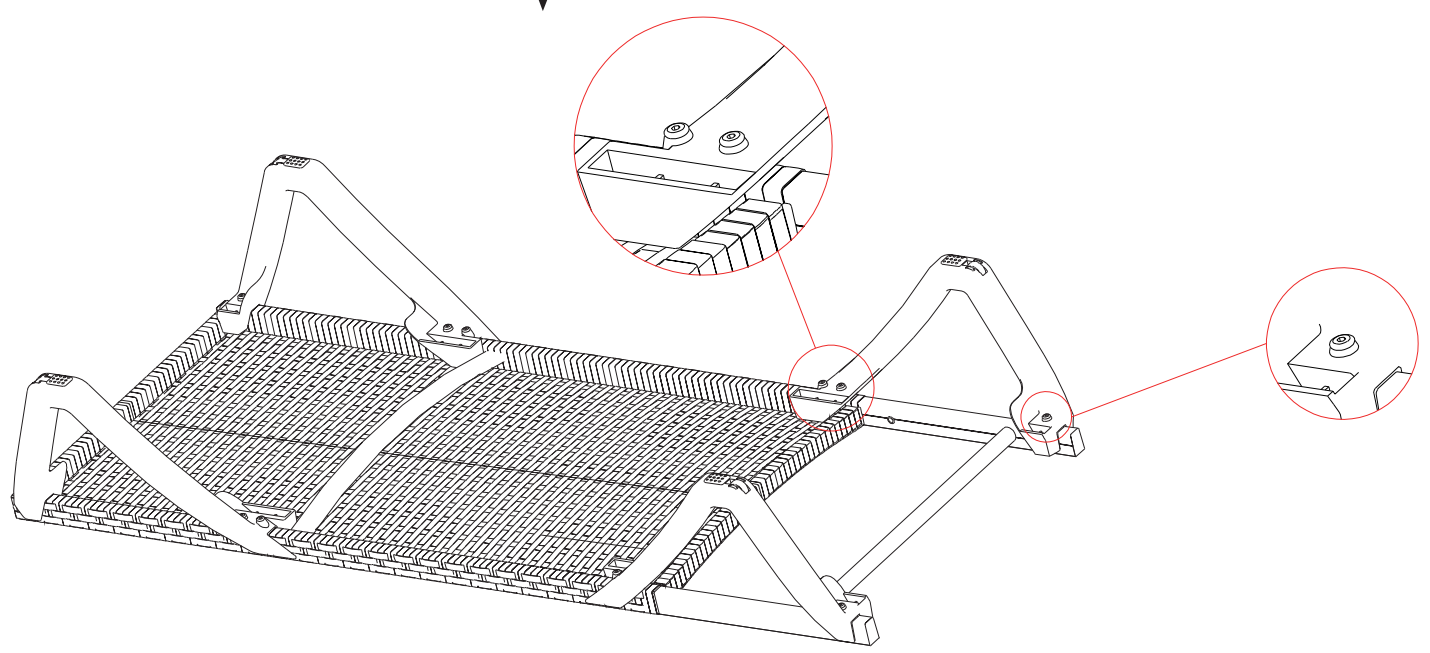
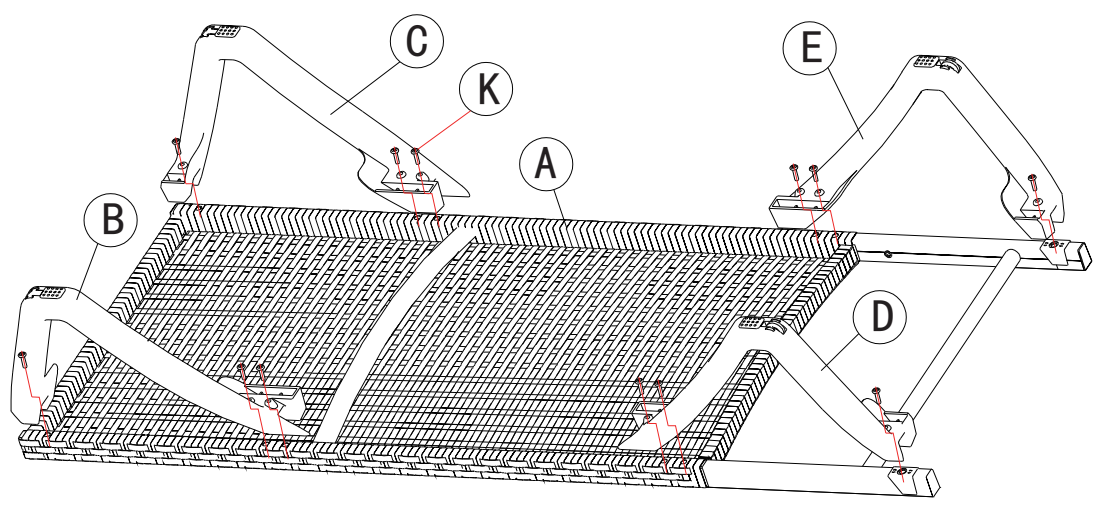

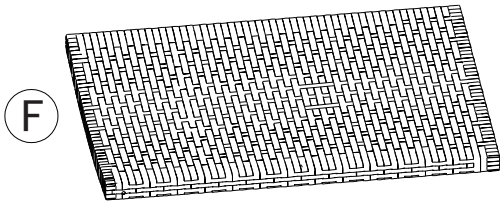

F

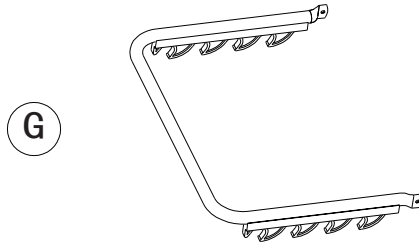

G

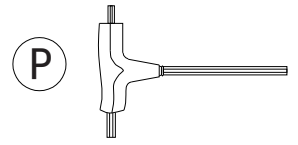

P

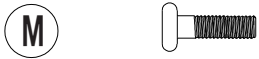

M

2X M6X25



L



2X

Step 2:

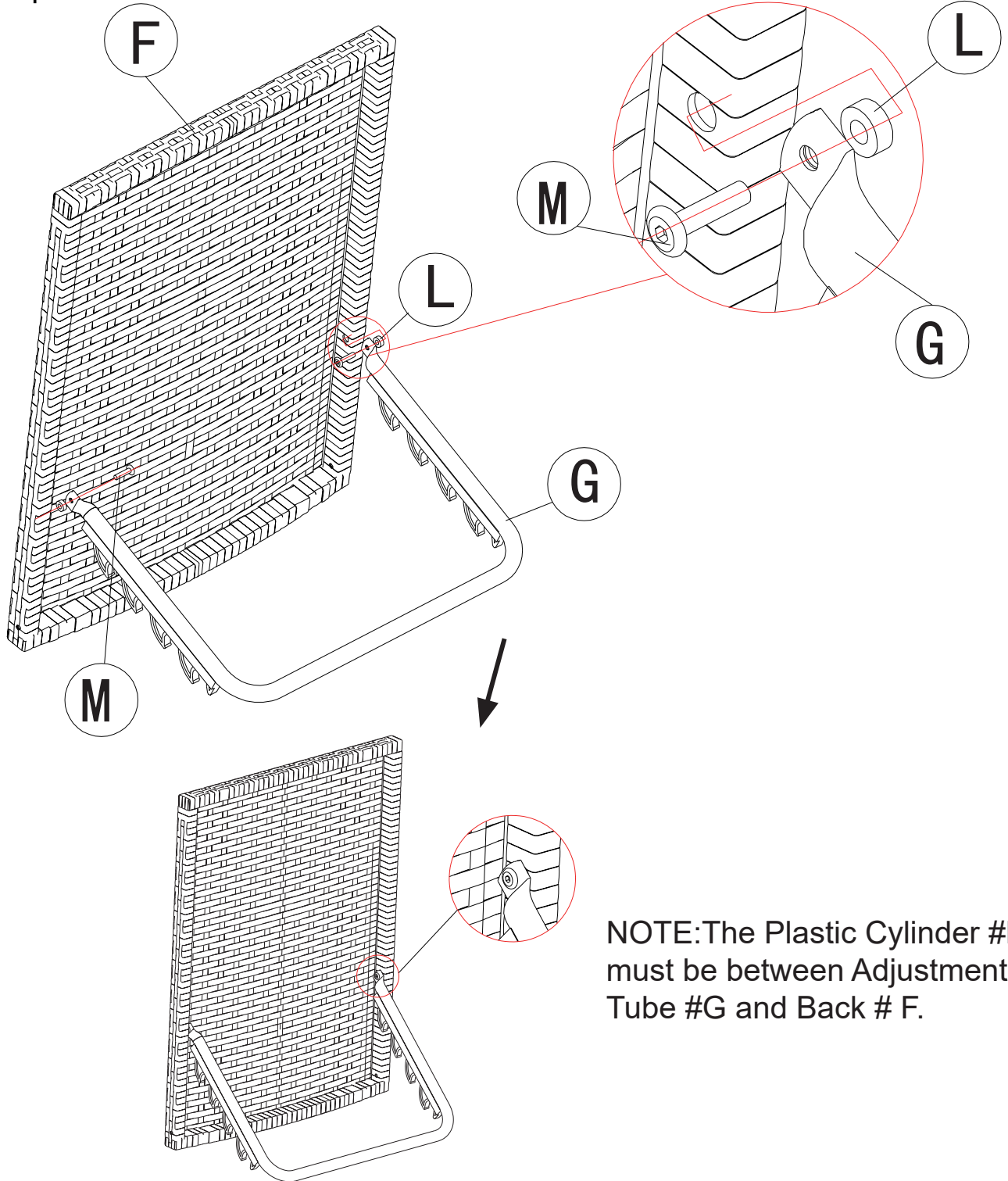

**NOTE:**The Plastic Cylinder #L must be between Adjustment Tube #G and Back # F.

(K)

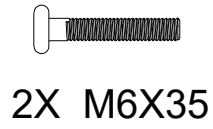

(P)

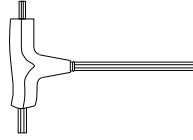

Step 3: Connect Back #F to Main Seat Frame #A using 2 Bolts #K (M6x35) as shown in diagram

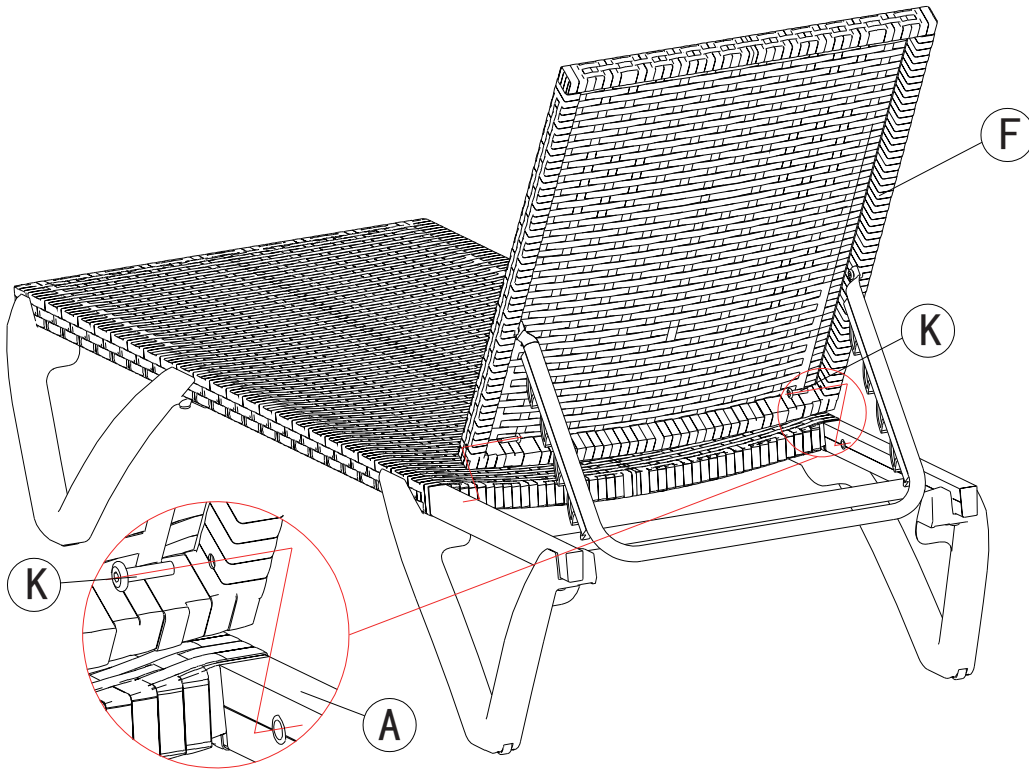

Tighten all the bolts

