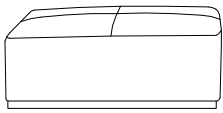
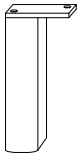
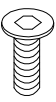

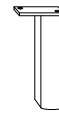
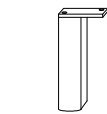
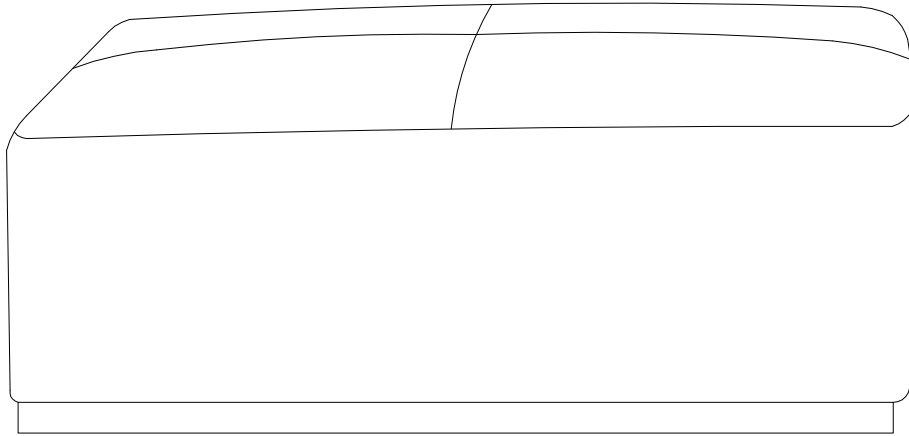

Diagram illustrating assembly instructions and safety warnings:

- Warning 1:** A warning triangle with an exclamation mark is connected by a vertical line to a box containing:
 - An icon of an L-shaped metal bracket.
 - An icon of a power drill with a slash through it, indicating that a power drill should not be used.
- Warning 2:** A second warning triangle with an exclamation mark is connected by a vertical line to a box containing:
 - An icon of a rectangular block being placed on a surface with a hatched pattern, representing a floor.
 - An icon of a rectangular block with a slash through it, indicating that the block should not be placed on a soft surface like a rug.
- Time:** A clock icon is positioned to the right of the first warning, with the text "10'" below it, indicating a 10-minute assembly time.
- Person:** An icon of a person is positioned to the right of the second warning, with the text "1" below it, indicating that one person is required for assembly.

A	B	C	D
		 M6 x 16	
x 1	x 4	x 8	x 1

A





B x 4

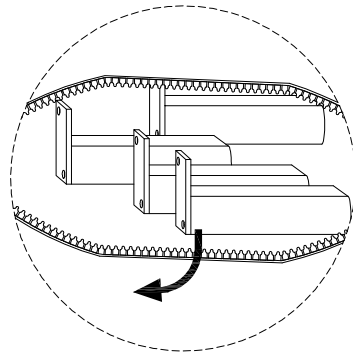
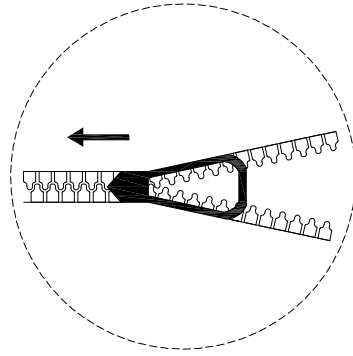
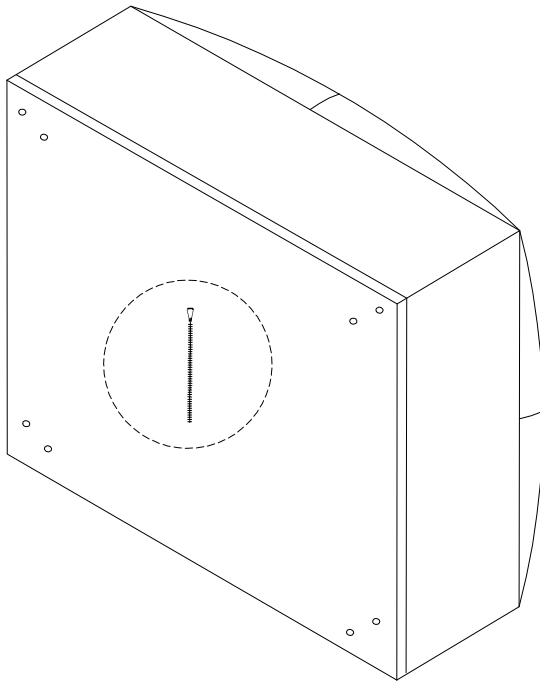

!

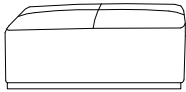

1

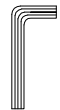
<p>A</p>  <p>x 1</p>	<p>B</p>  <p>x 4</p>	<p>C</p>  <p>M6 x 16 x 8</p>	<p>D</p>  <p>x 1</p>
--	--	---	--

