

ASSEMBLY INSTRUCTIONS

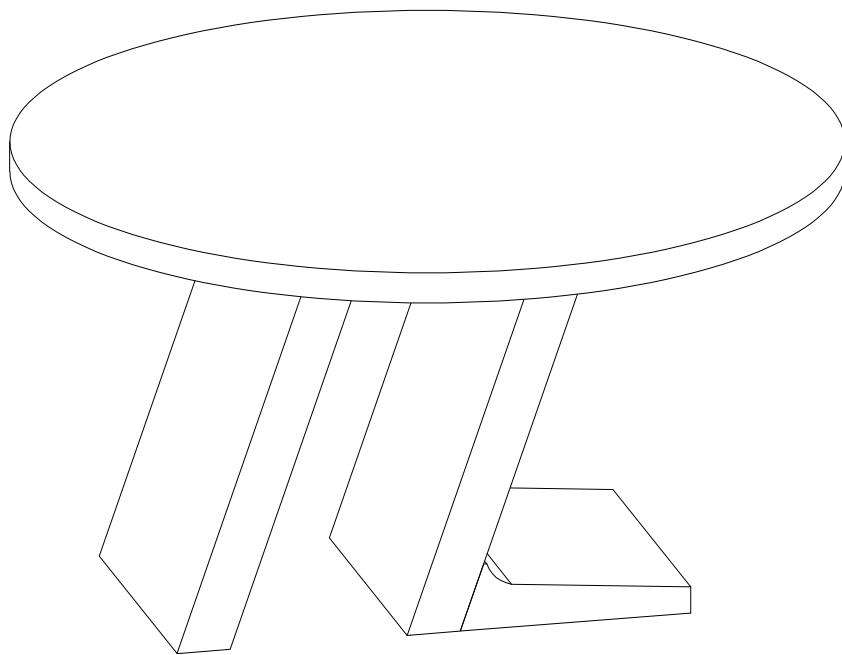

TOOLS REQUIRED

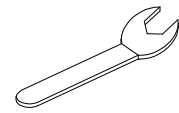

(Included)

Wrench

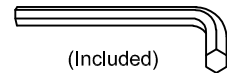

(Included)

Allen Wrench



2 - People

ASSEMBLY RATING



EASY → DIFFICULT

The Assembly Rating is a 5-point system showing the level of effort needed to assemble a specific product.



CHECK BEFORE STARTING

Are you missing anything?

Double-check all parts, hardware and accessories listed are all accounted for.

Check out our Quick Tips!

We recommend reviewing the pre-assembly handouts. Even experts need a refresher now and then!

Should we send any replacements?

Are there any irregularities or flaws in the parts? We can send replacements!

Prep Time!

Please review the assembly instructions and all diagrams prior to assembling.

PRE ASSEMBLY INTRODUCTION

We understand building ready-to-assemble furniture can be a challenging experience for some. To help avoid confusion, we have provided some helpful tips that may speed up the process.



Teamwork

ALWAYS have at least two people to help with transporting and assembling the product to avoid potential injury and/or damage.



Suitable Location

Assembling near the area of the intended location is highly recommended.



Sufficient Space

Make sure you have enough space to move around during the assembly.



Avoid Scratches

Use cardboard, blankets or a carpeted area while assembling furniture to prevent to prevent scratches and damages.



Flat Surface

Make sure the furniture rests on a flat and level surface with each leg evenly touching the floor.

ASSEMBLY AND CARE ADVICE



FAILURE TO FOLLOW THE GUIDELINES BELOW MAY RESULT IN INJURY AND/OR PROPERTY DAMAGE.



Position each part correctly and insert screws or bolts into their respective holes.



Turn clockwise to tighten and only tighten when step is completed or when instructed to do so.



Use the appropriate hand tools or power tools for assembly. Select steps, such as tightening screws and/or bolts, may require hand tools to avoid causing damage during assembly.



Save the instructions and store any supplied tools for later maintenance.



After two weeks, check and tighten any loose hardware and repeat again every six months thereafter.

IT IS THE USER'S RESPONSIBILITY TO MAINTAIN THE FURNITURE. THE HARDWARE MAY LOOSEN OVER TIME AND MAY CAUSE THE FURNITURE TO BE WOBBLY AND UNABLE TO SUPPORT ITS INTENDED WEIGHT CAPACITY. THIS MAY LEAD TO COLLAPSE AND MAY CAUSE SERIOUS INJURY.

ROUND DINING TABLE

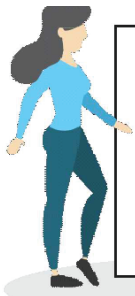

- Please keep instructions for future reference.
- Check the quantity and irregularity of parts and hardware before you start.

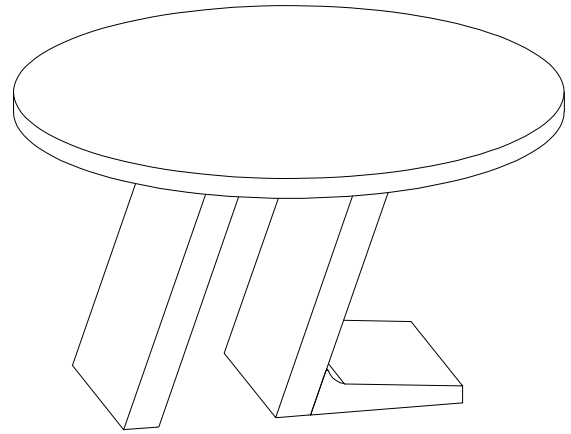

PARTS

1

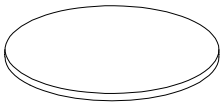

TOP TABLE

1 pc.

2



LEFT LEG

1 pc.

3



RIGHT LEG

1 pc.

4

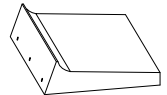

BASE

1 pc.

HARDWARE

A



Bolt $\text{Ø}5/16''$ x 1 3/4''

16 pcs.

B



Lock Washer $\text{Ø}5/16''$

16 pcs

C



Flat Washer $\text{Ø}5/16''$

16 pcs

D

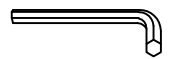

Allen Wrench M4

1 pc

E



Threaded Bolt $5/16''$ x 4''

3 pcs.

F



Half Round Nut $5/16''$

3 pcs.

G



Hexagon Nut $5/16''$





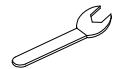



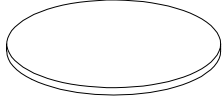

3 pcs.

H

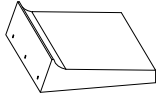

Wrench 1/2''

1 pcs.

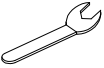
Carton	Designation	Part		Hardware
	Top table	①		 ① A 16pcs  ② B 16pcs
	Left Leg	②		 ③ C 16pcs  ④ D 1pc
	Left Leg	③		 ⑤ E 3pcs  ⑥ F 3pcs
	Base	④		 ⑦ G 3pcs  ⑧ H 1pc

ASSEMBLY INSTRUCTIONS

1

Part ③ x 1pc
Hardware ⑤ x 3pcs

Reattach 3 the threaded bolt (E) on the right leg (3)

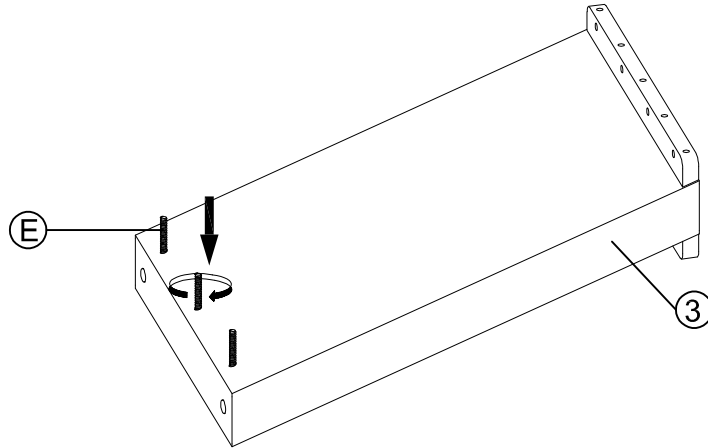

2

Part ③ x 1pc
Part ④ x 1pc
Hardware ⑥ x 3pcs
Hardware ⑦ x 3pcs
Hardware ⑧ x 1pcs

Align 3 the threaded bolt (E) of the right leg (3) to the base (4), then assemble the right legs and the base by half round nut (F), hexagon nut (G) using wrench (H)

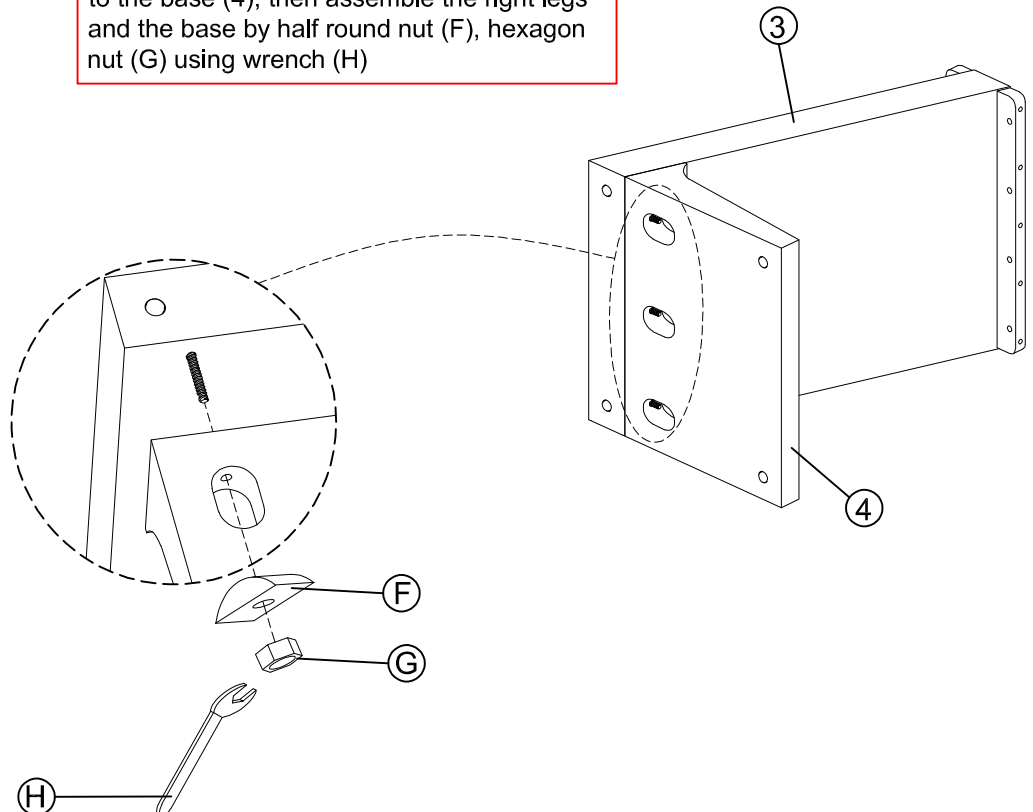

ASSEMBLY INSTRUCTIONS

3

- Part ① x 1pc
- Part ② x 1pc
- Part ③ x 1pc
- Hardware ④ x 16pcs
- Hardware ⑤ x 16pcs
- Hardware ⑥ x 16pcs
- Hardware ⑦ x 1pc

1. Prepare 16 bolt assemblies by first inserting a lock washer (B) onto the bolt (A) then a flat washer (C) onto that same bolt (A) .
2. Place the top table (1) face down onto a protected surface

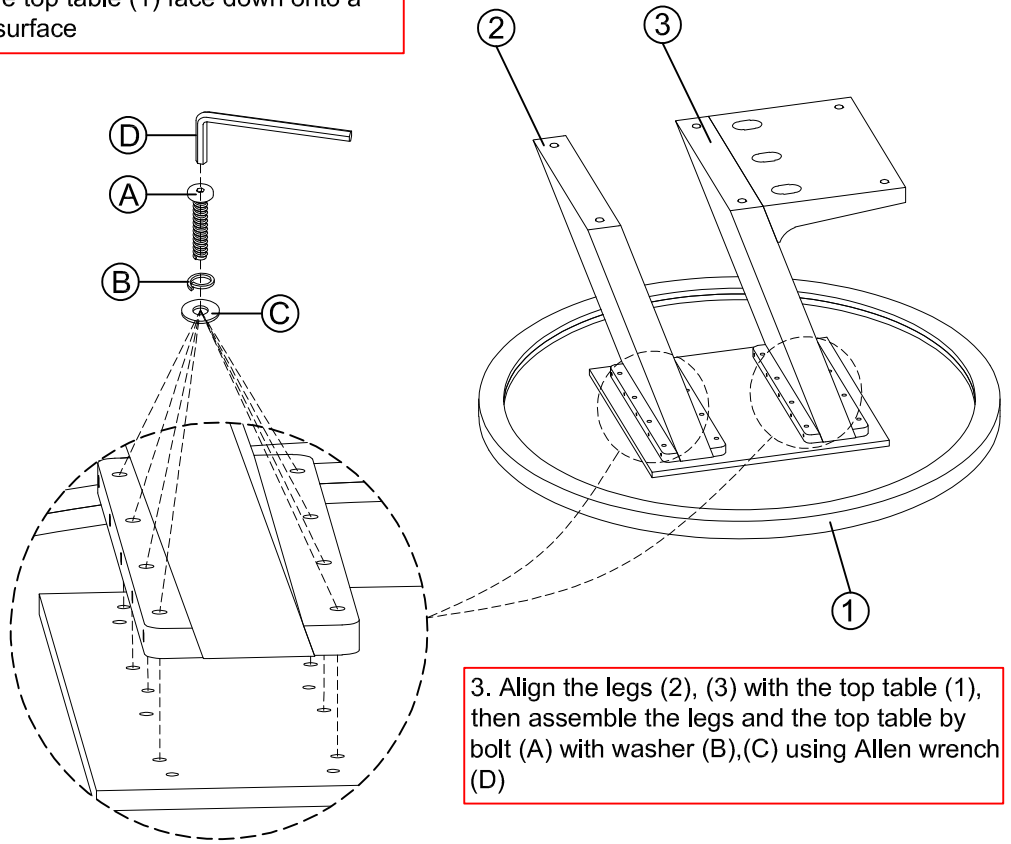

4

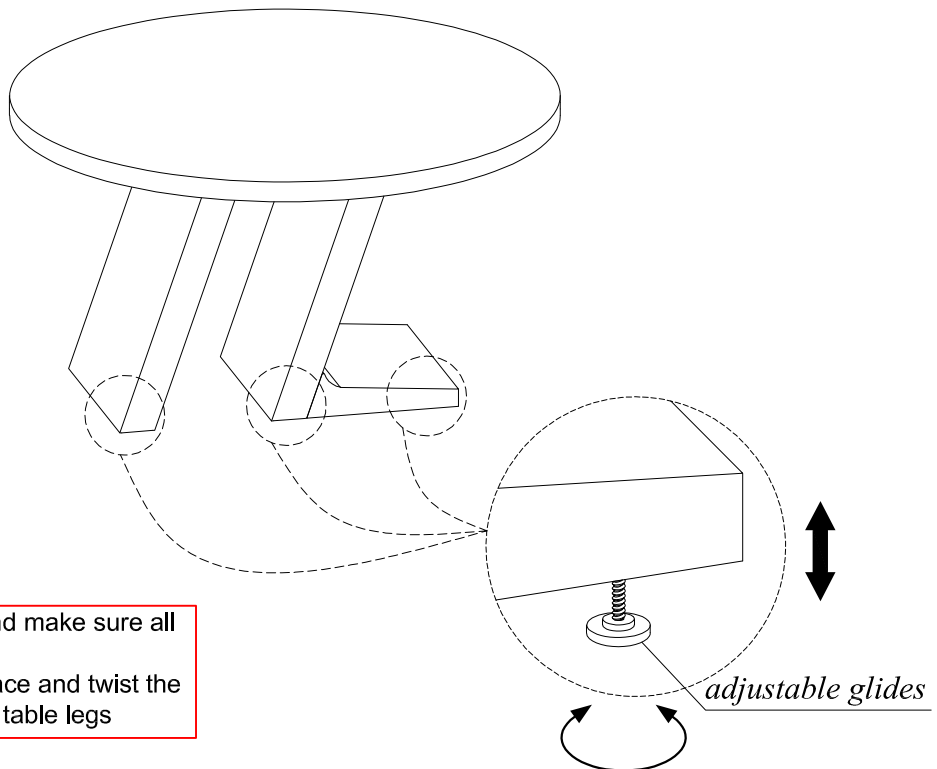

- Turn the end table upright and make sure all parts are firmly secured
- Place the table on a flat surface and twist the levelers on the bottom of the table legs

ASSEMBLY INSTRUCTIONS

5

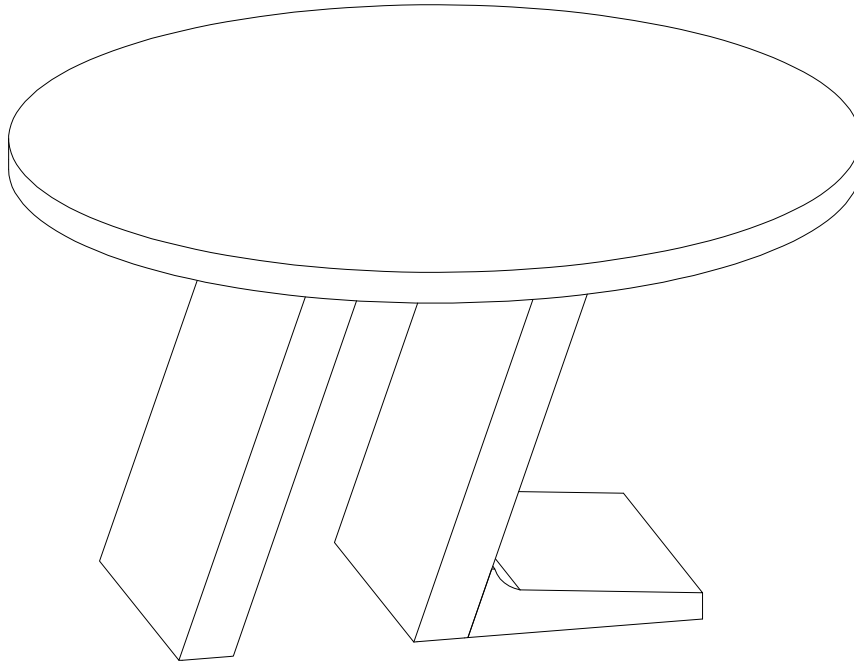

ASSEMBLY COMPLETED



Please ensure the furniture rests on an even and flat surface. If the product wobbles or feels loose, double-check all bolts and/or screws are properly tightened and secured.



Keep this handy!

Please retain this instruction manual and any order-related information for future reference.



Lift, don't drag!

To avoid damage to product please always LIFT the product when transporting or adjusting the placement.

This product is intended for RESIDENTIAL USE ONLY and not for commercial use.

ASSEMBLY INSTRUCTIONS

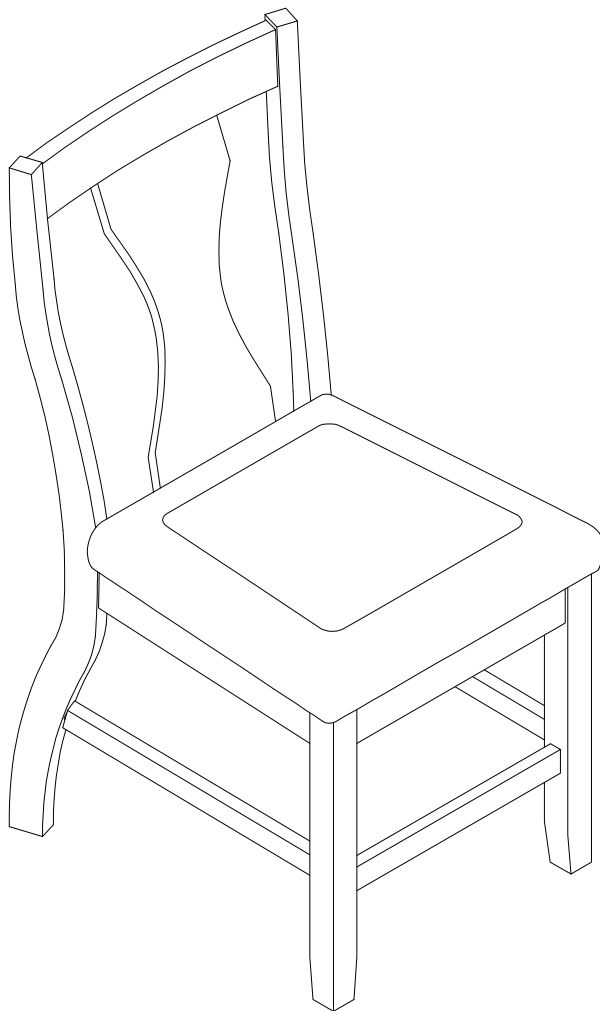

TOOLS REQUIRED



Screwdriver
(Not included)

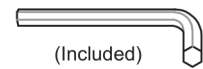

(Included)
Allen Wrench



2 - People

ASSEMBLY RATING



EASY → DIFFICULT

The Assembly Rating is a 5-point system showing the level of effort needed to assemble a specific product.



CHECK BEFORE STARTING

Are you missing anything?

Double-check all parts, hardware and accessories listed are all accounted for.

Check out our Quick Tips!

We recommend reviewing the pre-assembly handouts. Even experts need a refresher now and then!

Should we send any replacements?

Are there any irregularities or flaws in the parts? We can send replacements!

Prep Time!

Please review the assembly instructions and all diagrams prior to assembling.

PRE ASSEMBLY INTRODUCTION

We understand building ready-to-assemble furniture can be a challenging experience for some. To help avoid confusion, we have provided some helpful tips that may speed up the process.

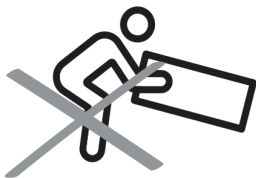

Teamwork

ALWAYS have at least two people to help with transporting and assembling the product to avoid potential injury and/or damage.

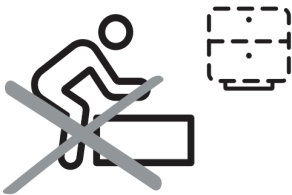

Suitable Location

Assembling near the area of the intended location is highly recommended.



Sufficient Space

Make sure you have enough space to move around during the assembly.



Avoid Scratches

Use cardboard, blankets or a carpeted area while assembling furniture to prevent to prevent scratches and damages.



Flat Surface

Make sure the furniture rests on a flat and level surface with each leg evenly touching the floor.

ASSEMBLY AND CARE ADVICE



FAILURE TO FOLLOW THE GUIDELINES BELOW MAY RESULT IN INJURY AND/OR PROPERTY DAMAGE.



Position each part correctly and insert screws or bolts into their respective holes.

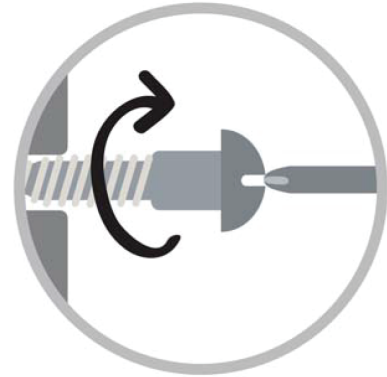

Turn clockwise to tighten and only tighten when step is completed or when instructed to do so.



Use the appropriate hand tools or power tools for assembly. Select steps, such as tightening screws and/or bolts, may require hand tools to avoid causing damage during assembly.



Save the instructions and store any supplied tools for later maintenance.



After two weeks, check and tighten any loose hardware and repeat again every six months thereafter.

IT IS THE USER'S RESPONSIBILITY TO MAINTAIN THE FURNITURE. THE HARDWARE MAY LOOSEN OVER TIME AND MAY CAUSE THE FURNITURE TO BE WOBBLY AND UNABLE TO SUPPORT ITS INTENDED WEIGHT CAPACITY. THIS MAY LEAD TO COLLAPSE AND MAY CAUSE SERIOUS INJURY.

DINING CHAIR (2PCS/CTN)

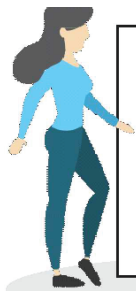

- Please keep instructions for future reference.
- Check the quantity and irregularity of parts and hardware before you start.

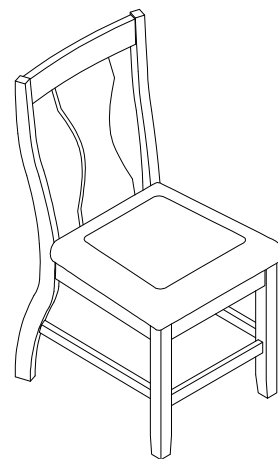

PARTS

1

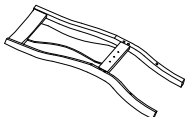

CHAIR BACK

1 pc x 2.

2

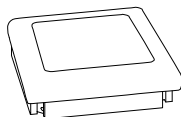

SEAT

1 pc x 2.

3



RIGHT LEG

1 pc x 2.

4



LEFT LEG

1 pc x 2.

5



RIGHT STRETCHER

1 pc x 2.

6



LEFT STRETCHER

1 pc x 2.

7

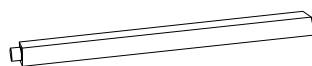

FRONT STRETCHER

1 pc x 2.

HARDWARE

A



Bolt Ø1/4" x 3 1/8"

4 pcs x 2.

B



Bolt Ø1/4" x 2 3/8"

4 pcs x 2.

C



Bolt Ø1/4" x 1 1/2"

2 pcs x 2.

D



Lock Washer Ø1/4"

10 pcs x 2.

E



Flat Washer Ø1/4"

10 pcs x 2.

F

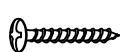

Wood Screw (Ø4* 1 1/2")











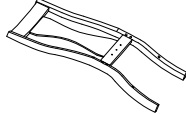

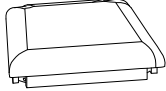
6 pcs x 2.

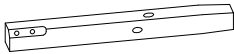
G



Allen Wrench M4

1 pc x 2

Carton	Designation	Part		Hardware
	Chair Back	①		 ① A 4pcs  ② B 4pcs
	Seat	②		 ③ C 2pcs  ④ D 10pcs
	Right Leg	③		 ⑤ E 10pcs  ⑥ F 6pcs
	Left Leg	④		 ⑦ G 1pc
	Right Stretcher	⑤		
	Left Stretcher	⑥		
	Front Stretcher	⑦		

ASSEMBLY INSTRUCTIONS

1

- Part ① x 1pc
- Part ② x 1pc
- Hardware ① x 4pcs
- Hardware ② x 2pcs
- Hardware ③ x 6pcs
- Hardware ④ x 6pcs
- Hardware ⑤ x 1pc

1. Prepare 4 bolt assemblies by first inserting a lock washer (D) onto the bolt (A) then a flat washer (E) onto that same bolt (A).

Prepare 2 bolt assemblies by first inserting a lock washer (D) onto the bolt (C) then a flat washer (E) onto that same bolt (C).

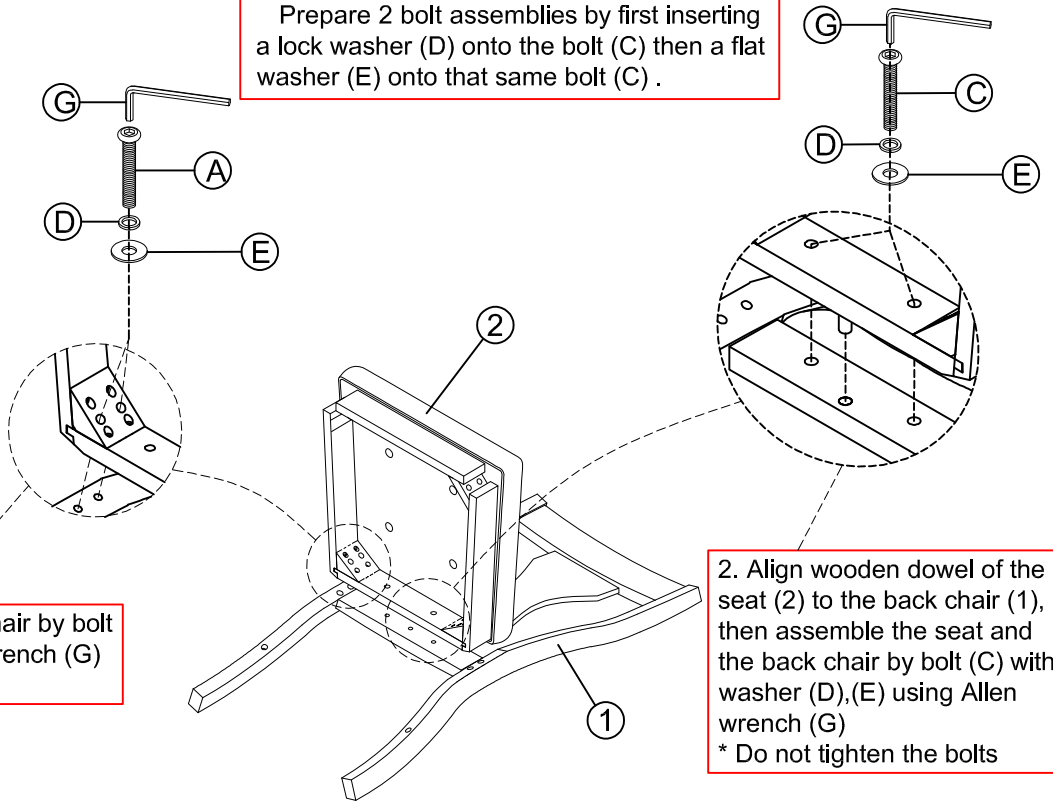

3. Assemble the seat and the back chair by bolt (A) with washer (D),(E) using Allen wrench (G)
* Do not tighten the bolts

2. Align wooden dowel of the seat (2) to the back chair (1), then assemble the seat and the back chair by bolt (C) with washer (D),(E) using Allen wrench (G)
* Do not tighten the bolts

2

- Part ③ x 1pc
- Part ④ x 1pc
- Hardware ⑥ x 4pcs
- Hardware ⑦ x 4pcs
- Hardware ⑧ x 4pcs
- Hardware ⑨ x 1pc

1. Prepare 4 bolt assemblies by first inserting a lock washer (D) onto the bolt (B) then a flat washer (E) onto that same bolt (B).

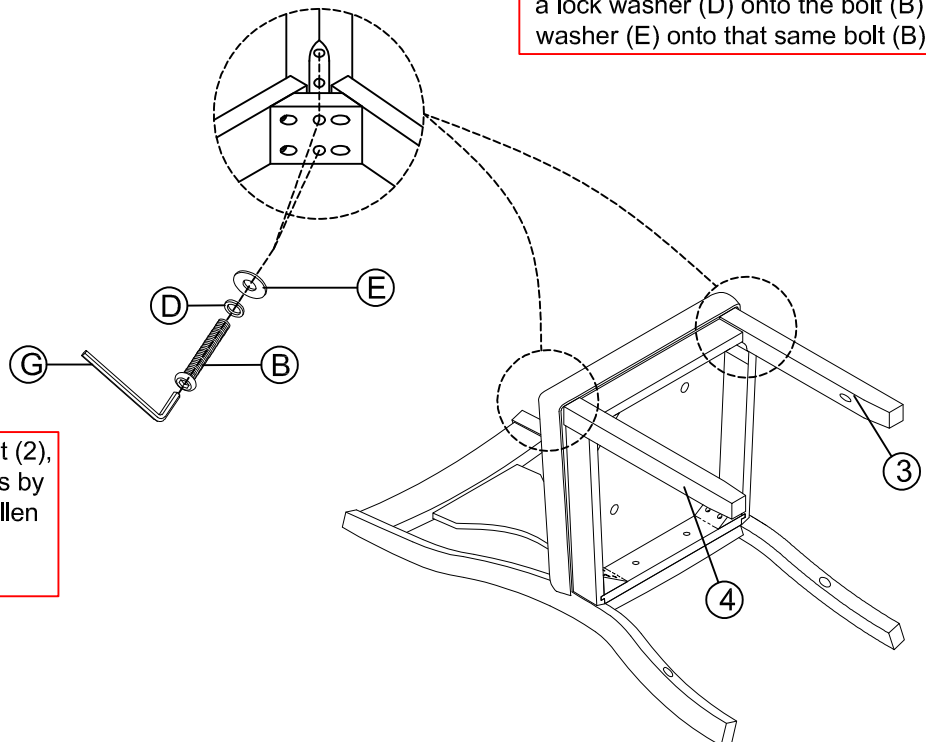

2. Align front legs (3), (4) to the seat (2), then assemble the seat and the legs by bolt (B) with washer (D),(E) using Allen wrench (G)
* Do not tighten the bolts

ASSEMBLY INSTRUCTIONS

3

- Part ⑤ x 1pc
- Part ⑥ x 1pc
- Part ⑦ x 1pc
- Hardware ① x 6pcs

1. Prepare 6 screw (F)
2. Place right, left stretcher (5), (6) to middle the back legs and front leg, front stretcher (7) to middle the front legs, then assemble the stretchers and the legs by screw (F) using screwdriver.
* Do not tighten the screw

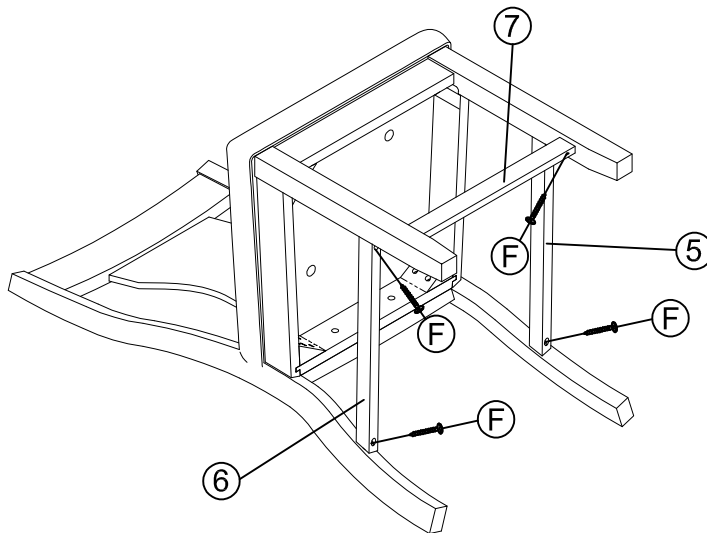

4

- To level the chair, stand the chair up on a flat surface and tighten all the bolts by using Allen Wrench (G) and tighten all the screws by using a screwdriver.

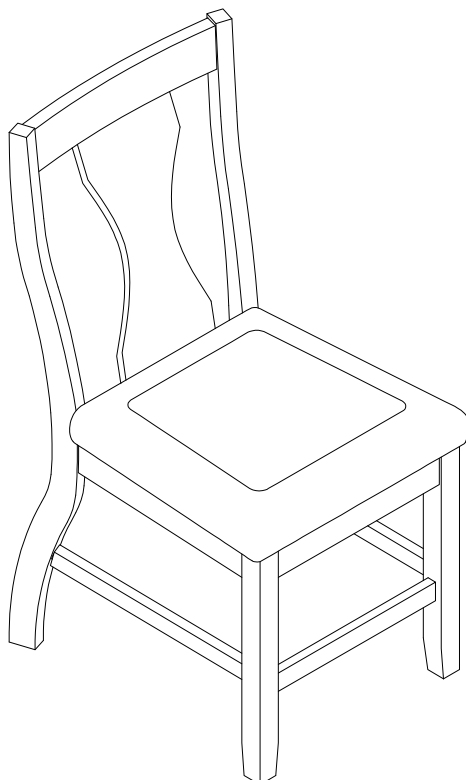

ASSEMBLY COMPLETED



Please ensure the furniture rests on an even and flat surface. If the product wobbles or feels loose, double-check all bolts and/or screws are properly tightened and secured.

✓ Keep this handy!

Please retain this instruction manual and any order-related information for future reference.

✓ Lift, don't drag!

To avoid damage to product please always LIFT the product when transporting or adjusting the placement.

This product is intended for RESIDENTIAL USE ONLY and not for commercial use.