

ASSEMBLY INSTRUCTIONS

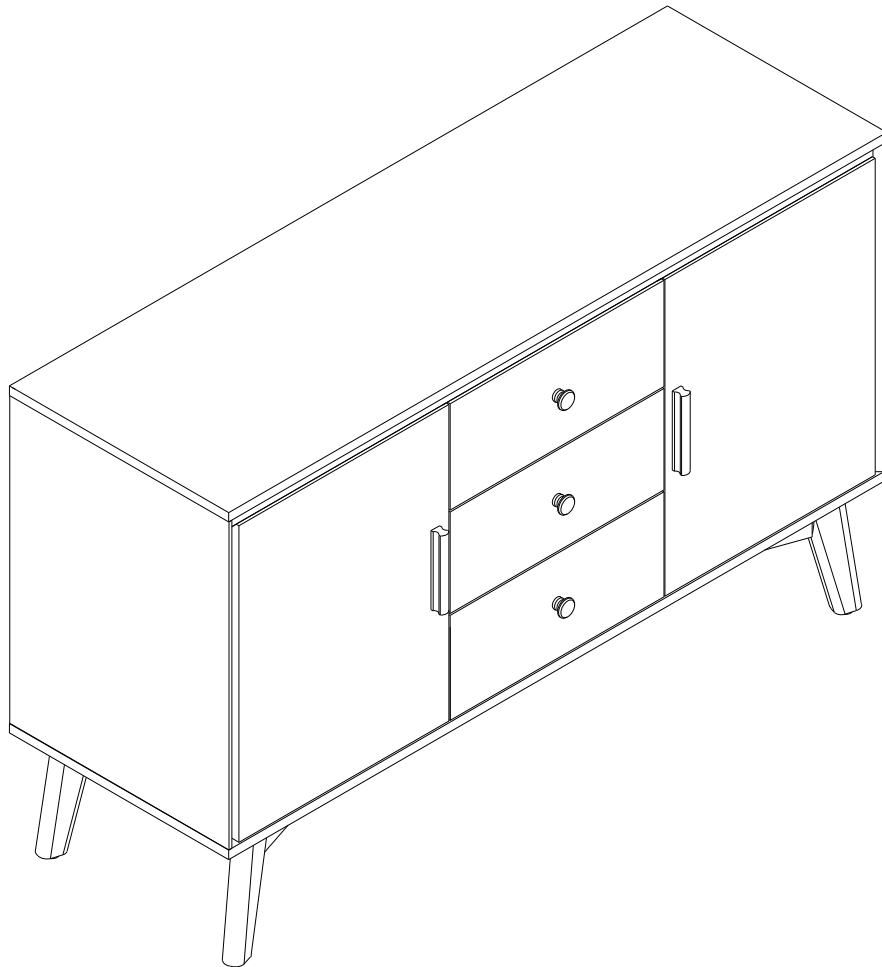

Notice:

1. Follow the installation instructions. Please confirm all accessories are preset before installation.
2. Do not fully tighten the screws during initial assembly. Fully tighten screws only once all pieces which are correctly assembled.
3. If you encounter any problems during installation, please contact our customer service.
4. Please unbox the item from the side with an open-label and put a carpet on the floor to avoid scratching it.

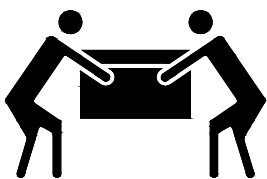

Recommended installers:2

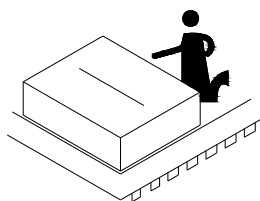

Put a carpet on the floor
before unpacking

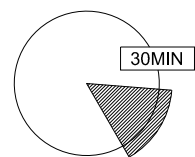

Estimate installation time:
30minutes

ASSEMBLY INSTRUCTIONS

PART LIST

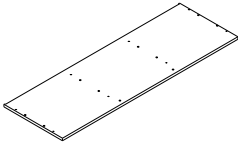
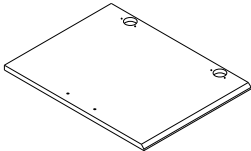
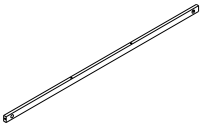
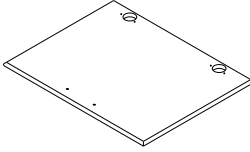
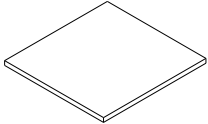
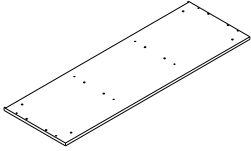
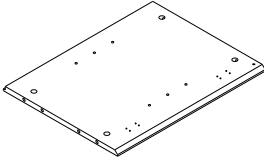
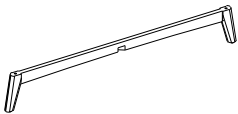
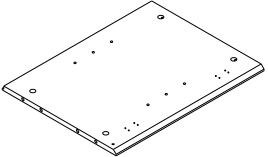
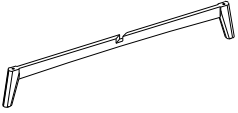
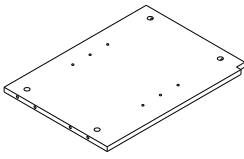
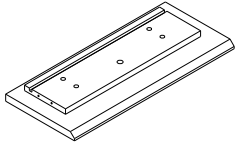
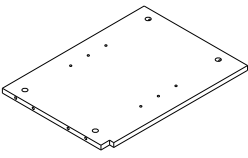
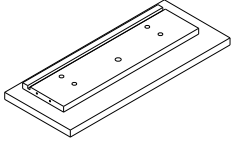
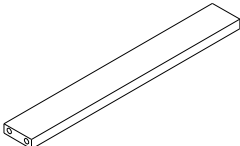
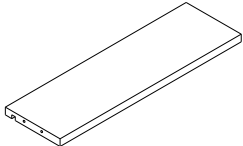
Item no.	Reference Image	Qty	Item no.	Reference Image	Qty
(A)		X1	(I)		X1
(B)		X1	(J)		X1
(C)		X2	(K)		X1
(D)		X1	(L)		X1
(E)		X1	(M)		X1
(F)		X1	(N)		X1
(G)		X1	(O)		X2
(H)		X2	(P)		X3





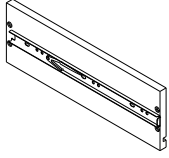
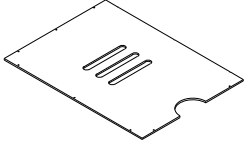
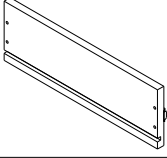
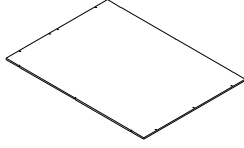
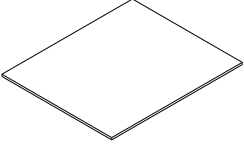
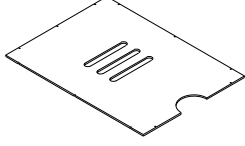

ASSEMBLY INSTRUCTIONS

PART LIST

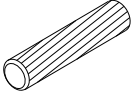
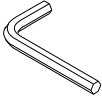
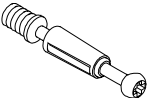
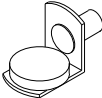
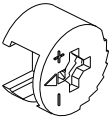
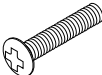
Item no.	Reference Image	Qty	Item no.	Reference Image	Qty
Ⓚ		X3	Ⓣ		X1
Ⓡ		X3	Ⓤ		X1
Ⓢ		X3	Ⓥ		X1

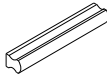
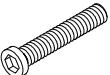
ASSEMBLY INSTRUCTIONS

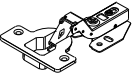
HARDWARE LIST

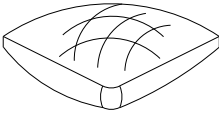
Item no.	Reference Image	Qty	Item no.	Reference Image	Qty
1	 Ø8*30mm	X22+2	8		X1
2		X22+2	9		X8
3		X22+2	10		X7
4	 Ø6.5*Ø3*15mm	X26+2	11		X2
5	 Ø1/4*1-3/4"	X4	12		X3
6		X4	13	 Ø7*Ø4*35mm	X24+2
7	 Ø6.5*Ø3*14mm	X24+2	14		X1

ASSEMBLY INSTRUCTIONS

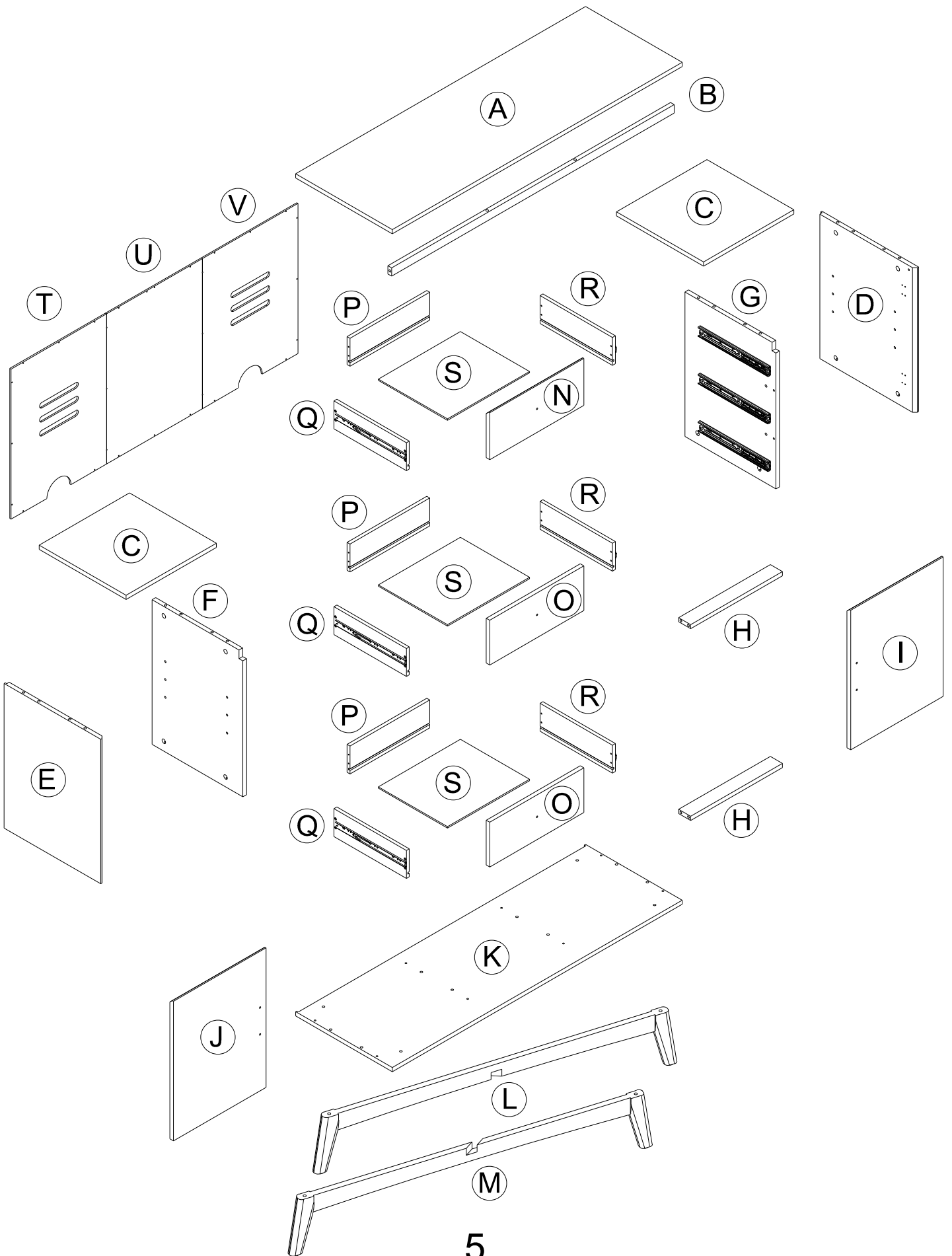

ASSEMBLY INSTRUCTIONS

1

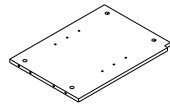

F 1pc

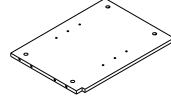

G 1pc

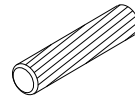

1 4pcs

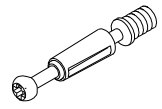

2 4pcs

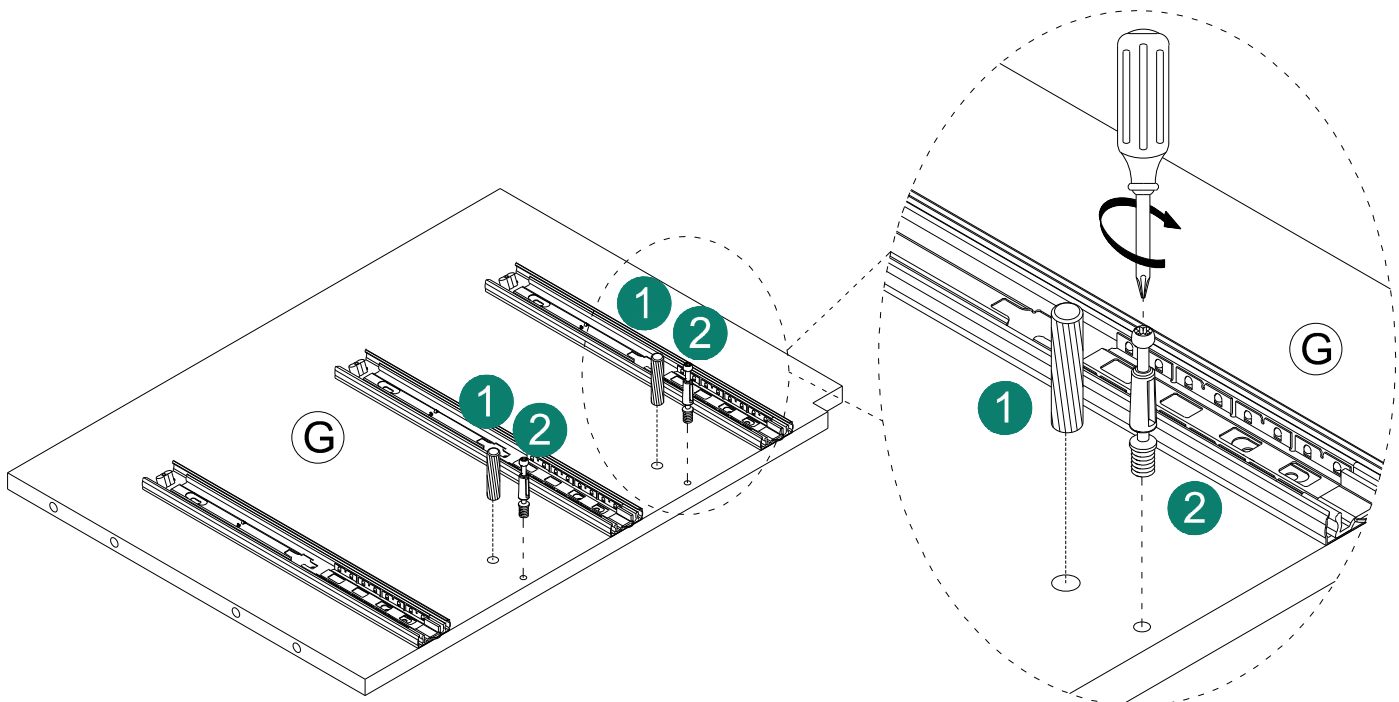
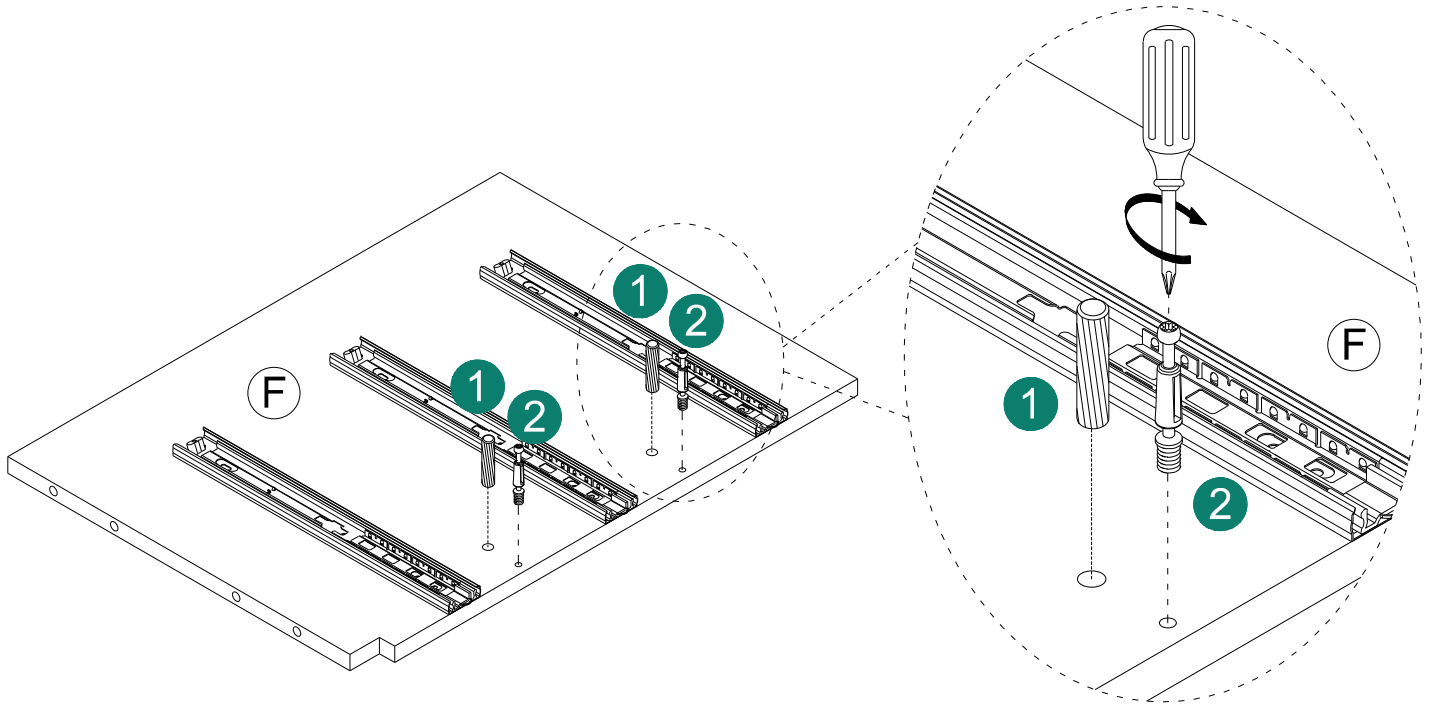

ASSEMBLY INSTRUCTIONS

2

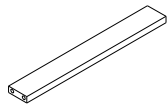

(H) 2pc

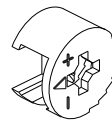

(3) 4pcs

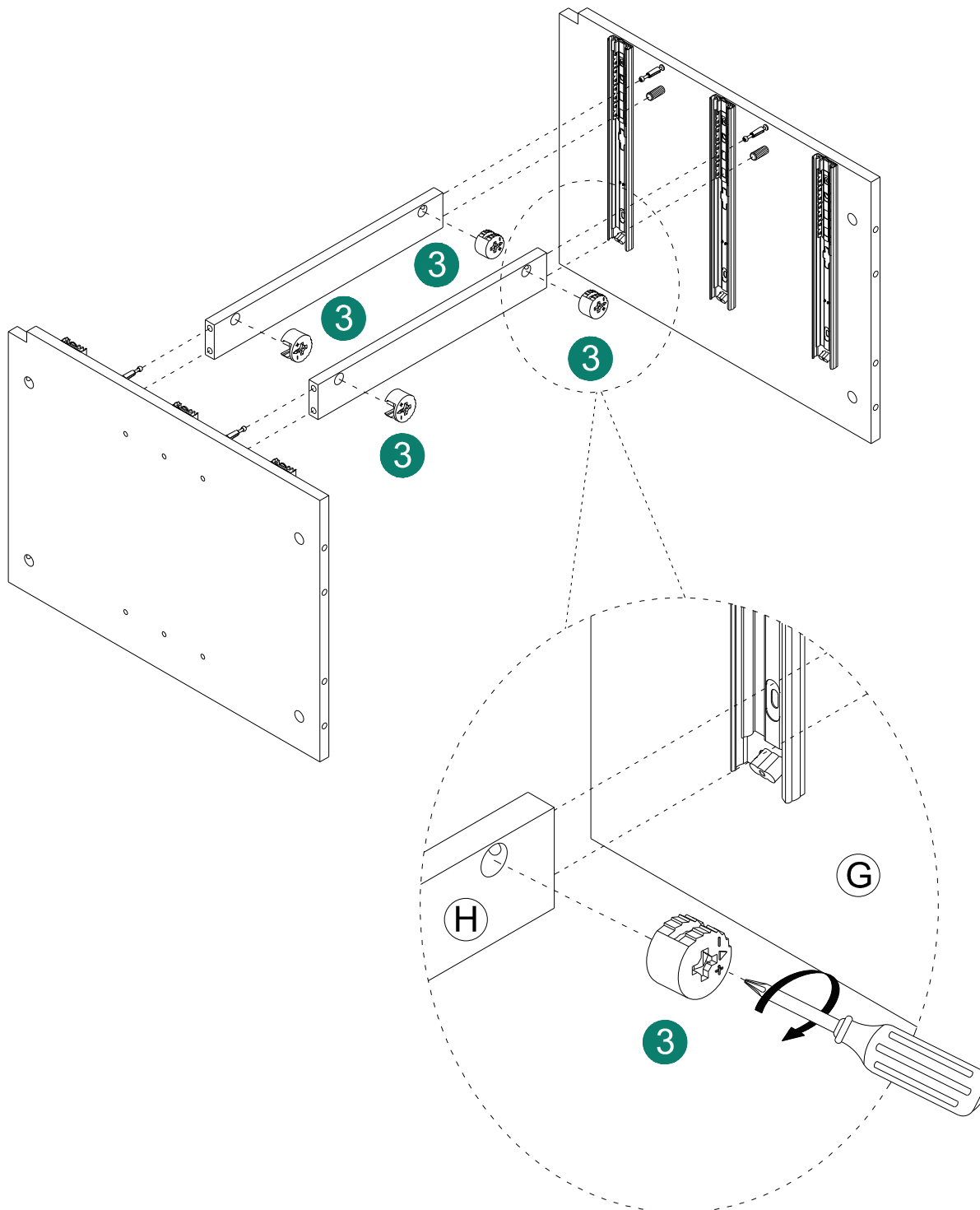

ASSEMBLY INSTRUCTIONS

3

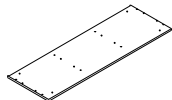

(K) 1pc



(L) 1pc

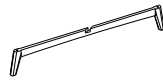

(M) 1pc

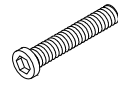

(5) 4pcs

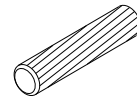

(1) 8pcs

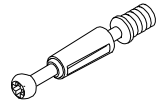

(2) 8pcs

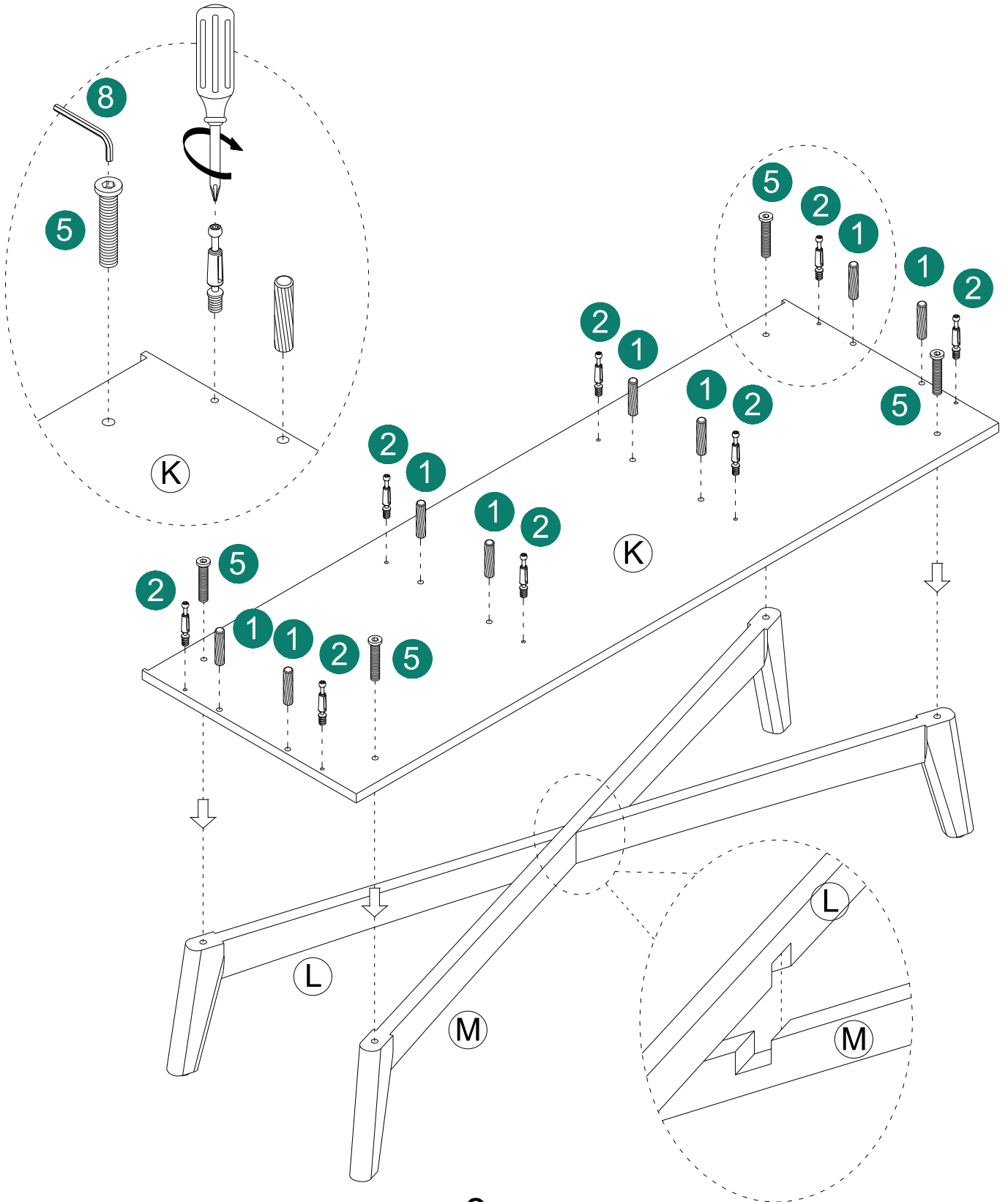

ASSEMBLY INSTRUCTIONS

4

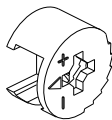

3 4pcs

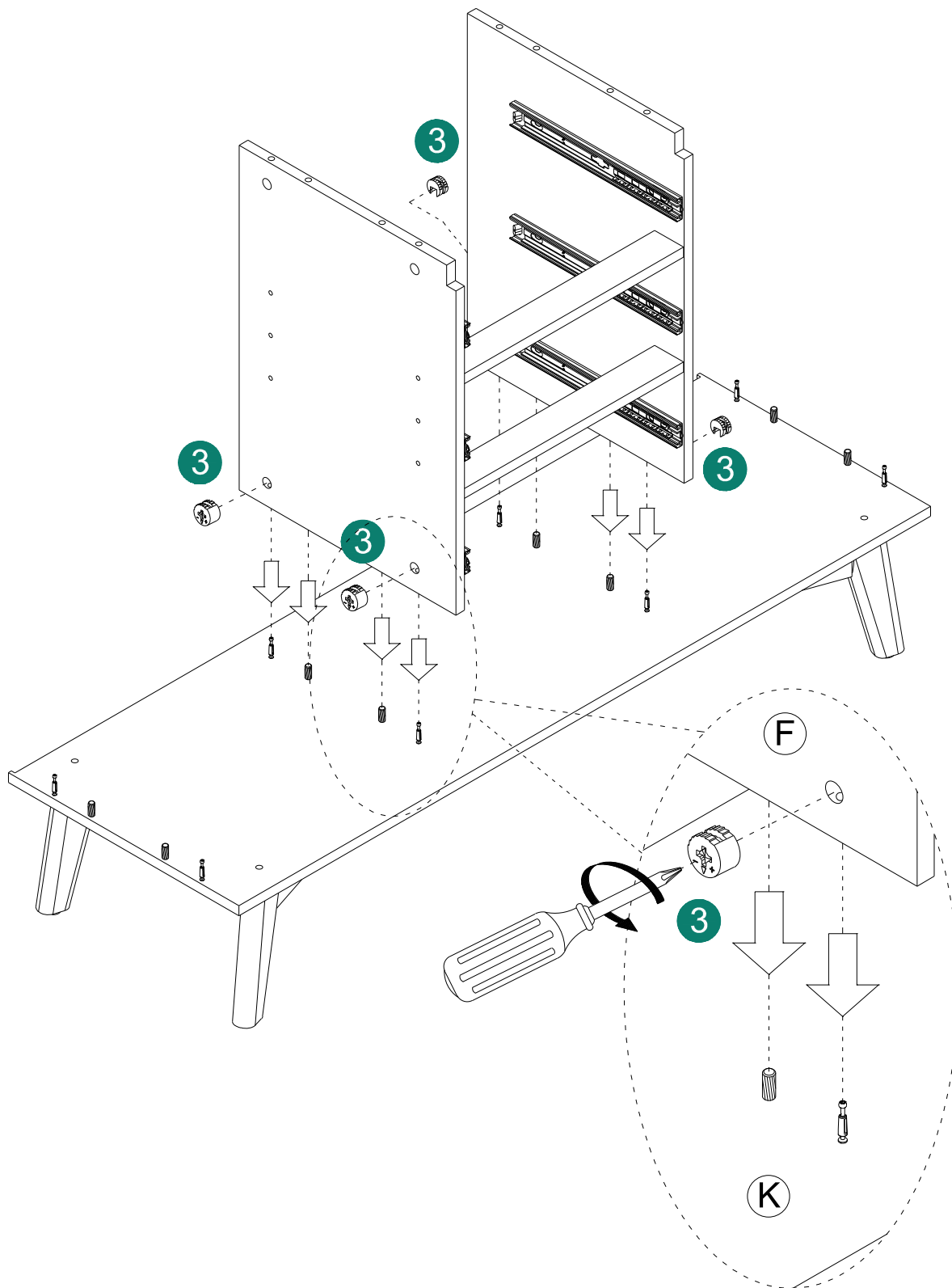

ASSEMBLY INSTRUCTIONS

5

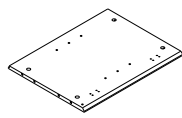

(E) 1pc

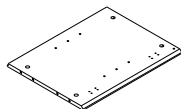

(D) 1pc

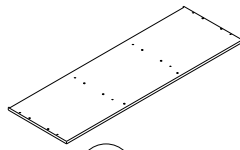

(A) 1pc

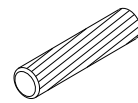

(1) 8pcs

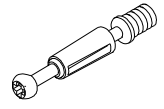

(2) 8pcs

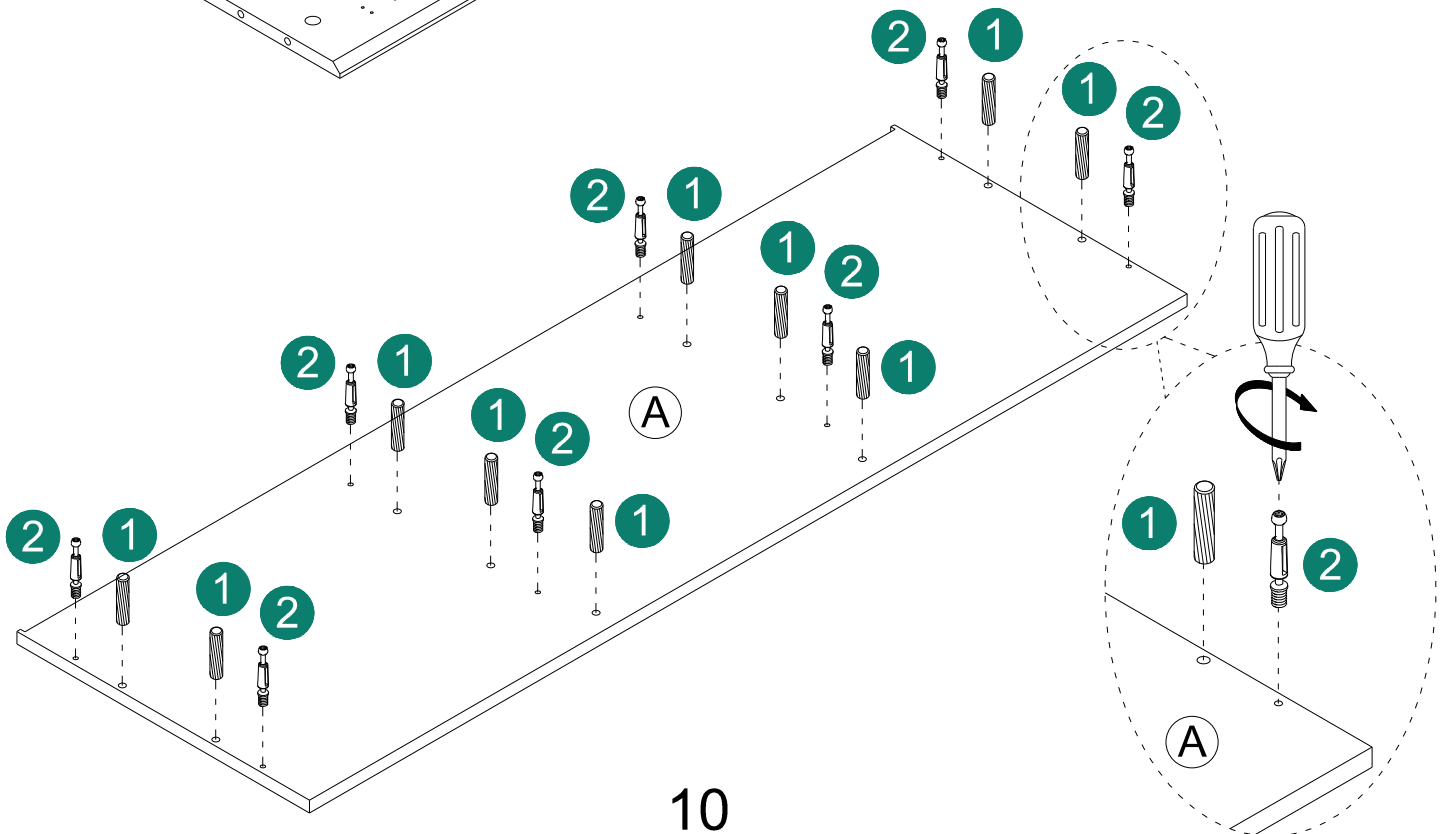
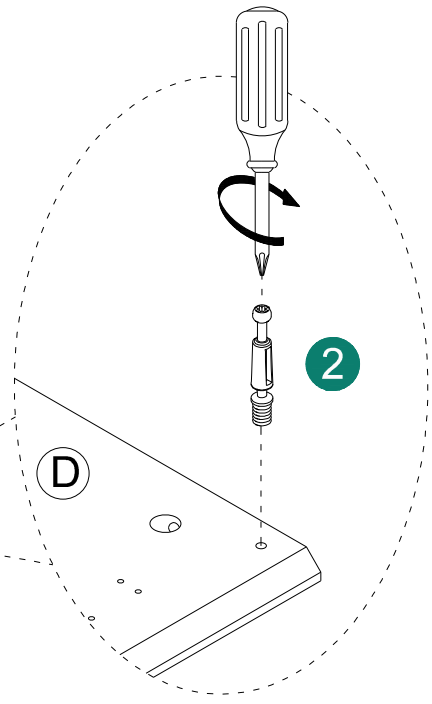
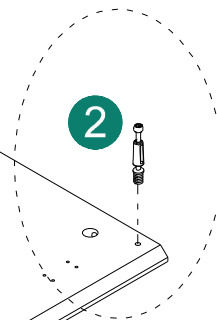
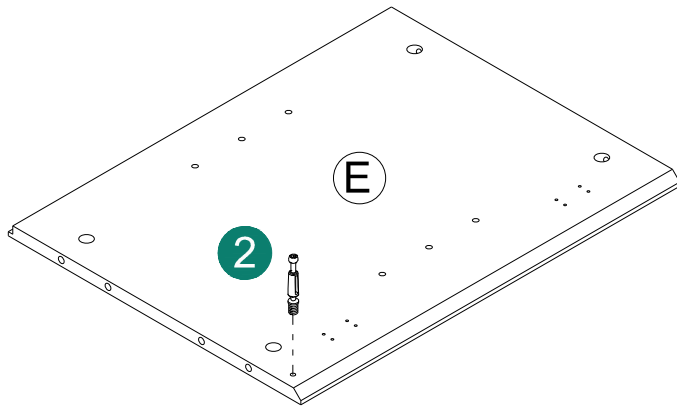

ASSEMBLY INSTRUCTIONS

6

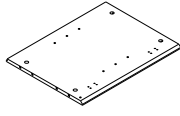

(E) 1pc

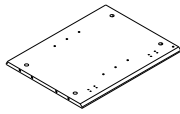

(D) 1pc

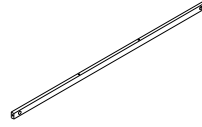

(B) 1pc

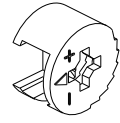

(3) 2pcs

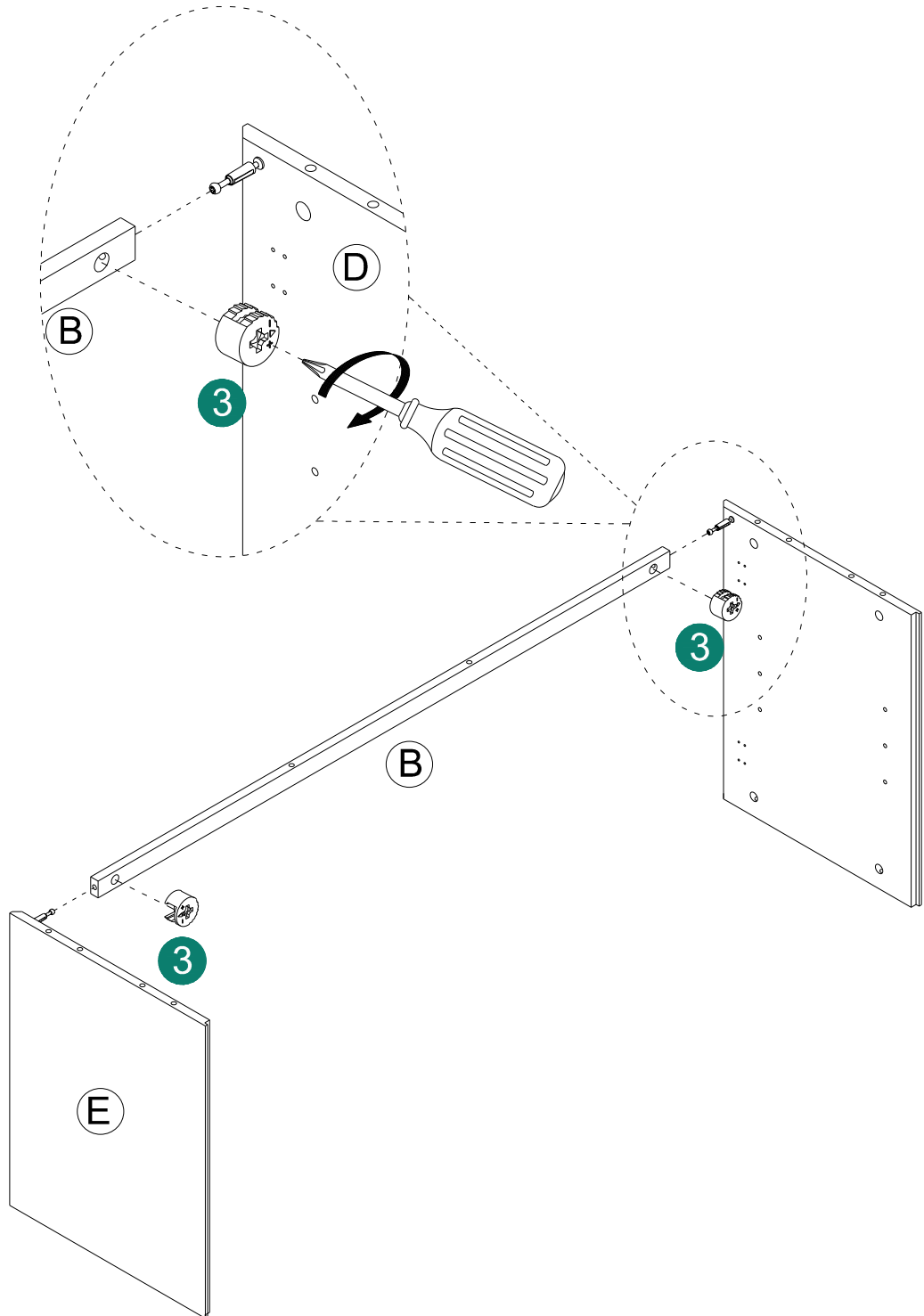

ASSEMBLY INSTRUCTIONS

7

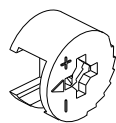

3 4pcs

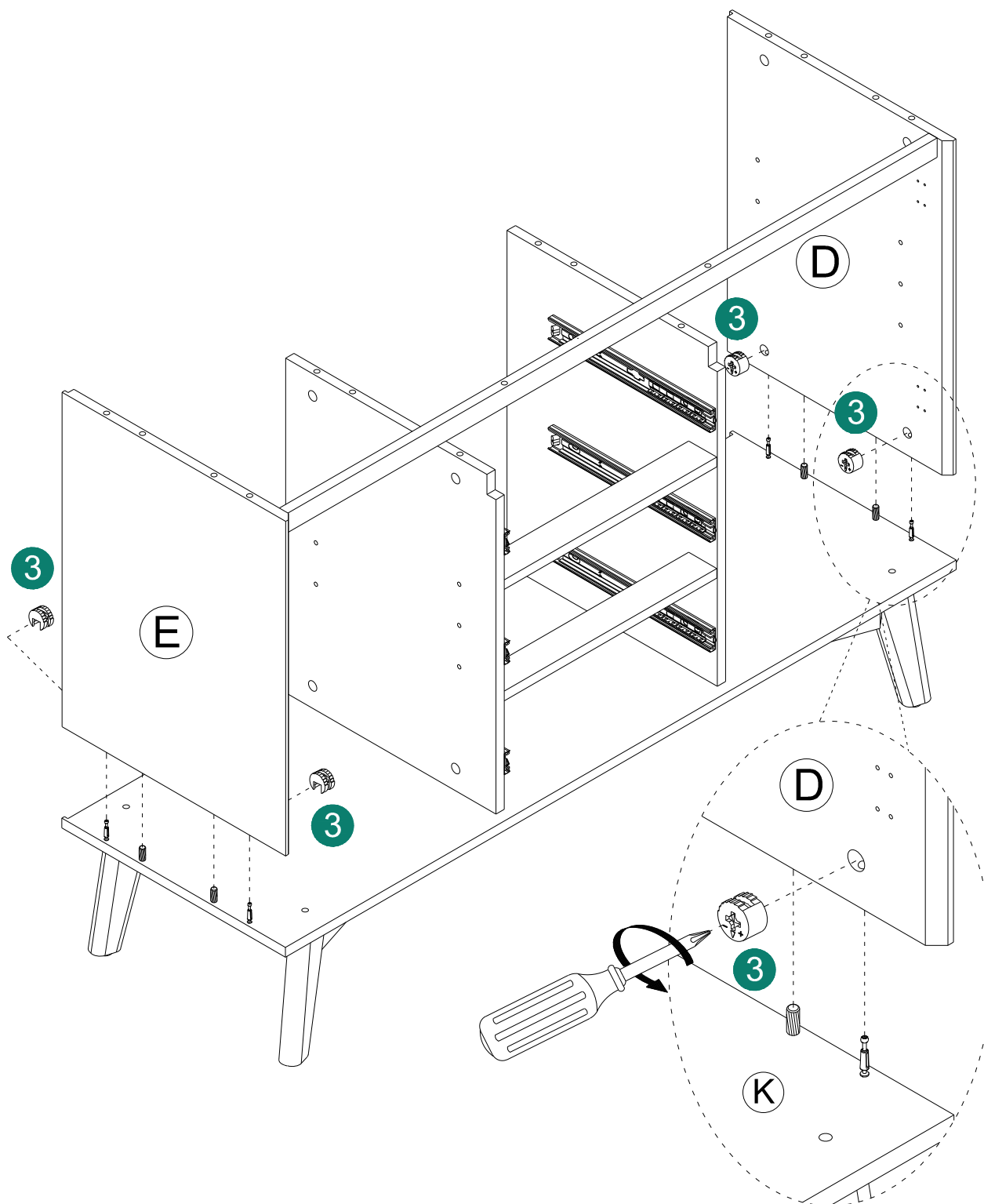

ASSEMBLY INSTRUCTIONS

8

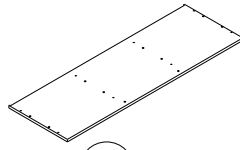

A 1pc

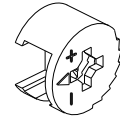

3 8pcs

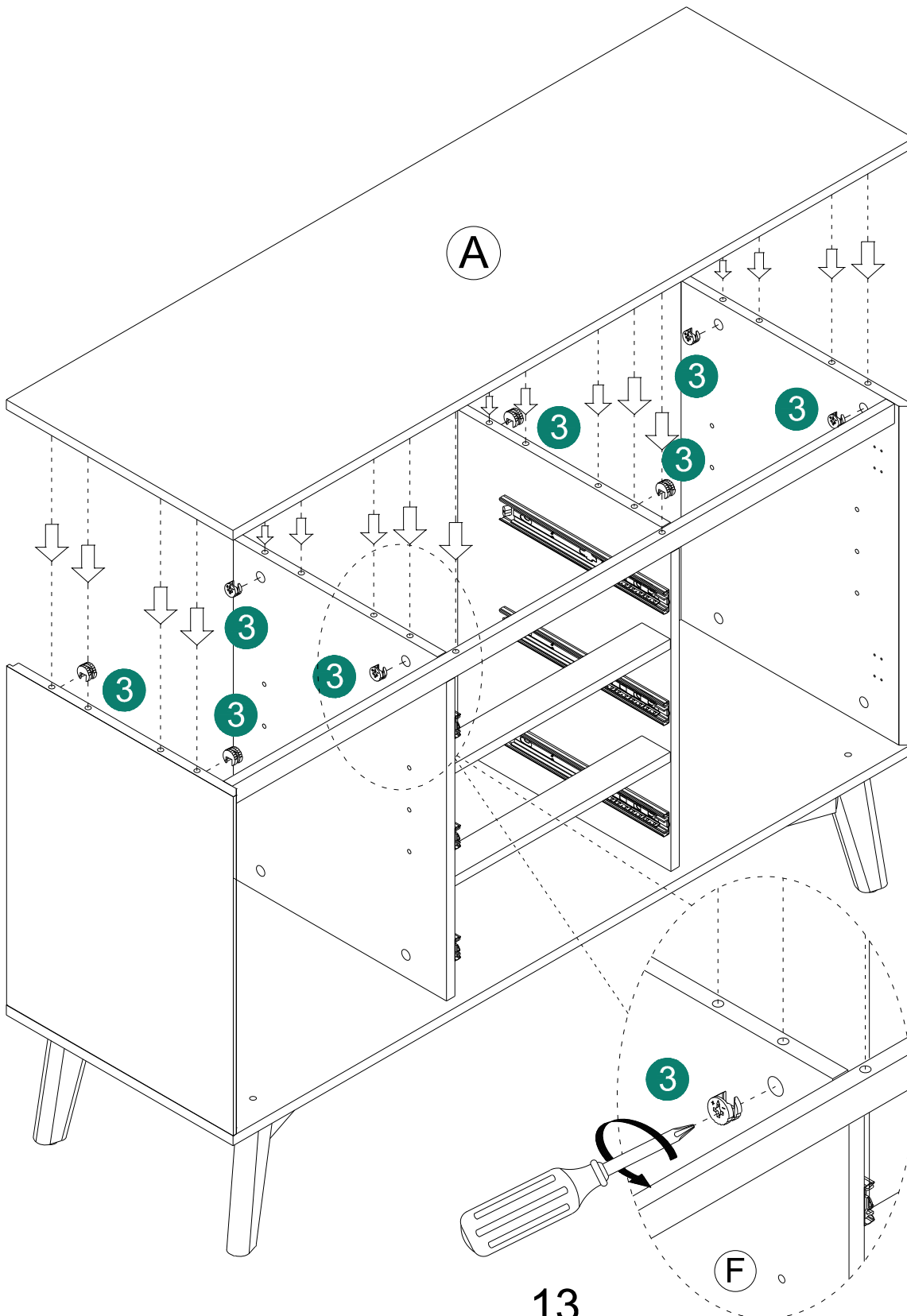

ASSEMBLY INSTRUCTIONS

9

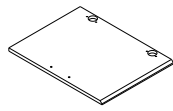

① 1pc

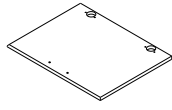

② 1pc



⑦ 8pcs



⑥ 4pcs

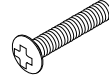

⑩ 4pcs



⑪ 2pcs

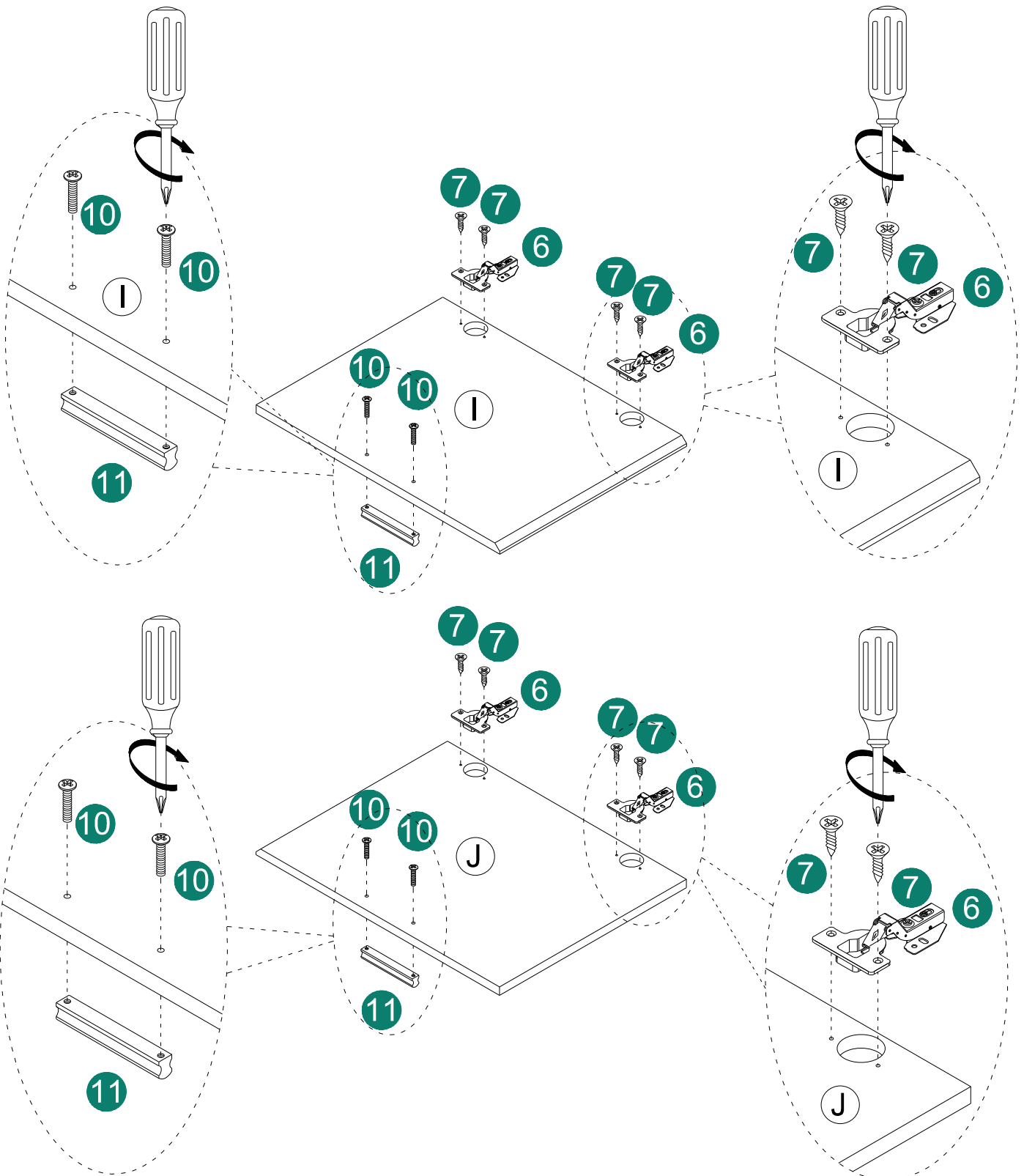

ASSEMBLY INSTRUCTIONS

10

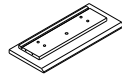

(N) 1pc

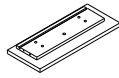

(O) 1pc



(Q) 3pc



(R) 3pc

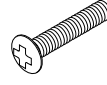

(10) 3pcs



(13) 12pcs



(12) 3pcs

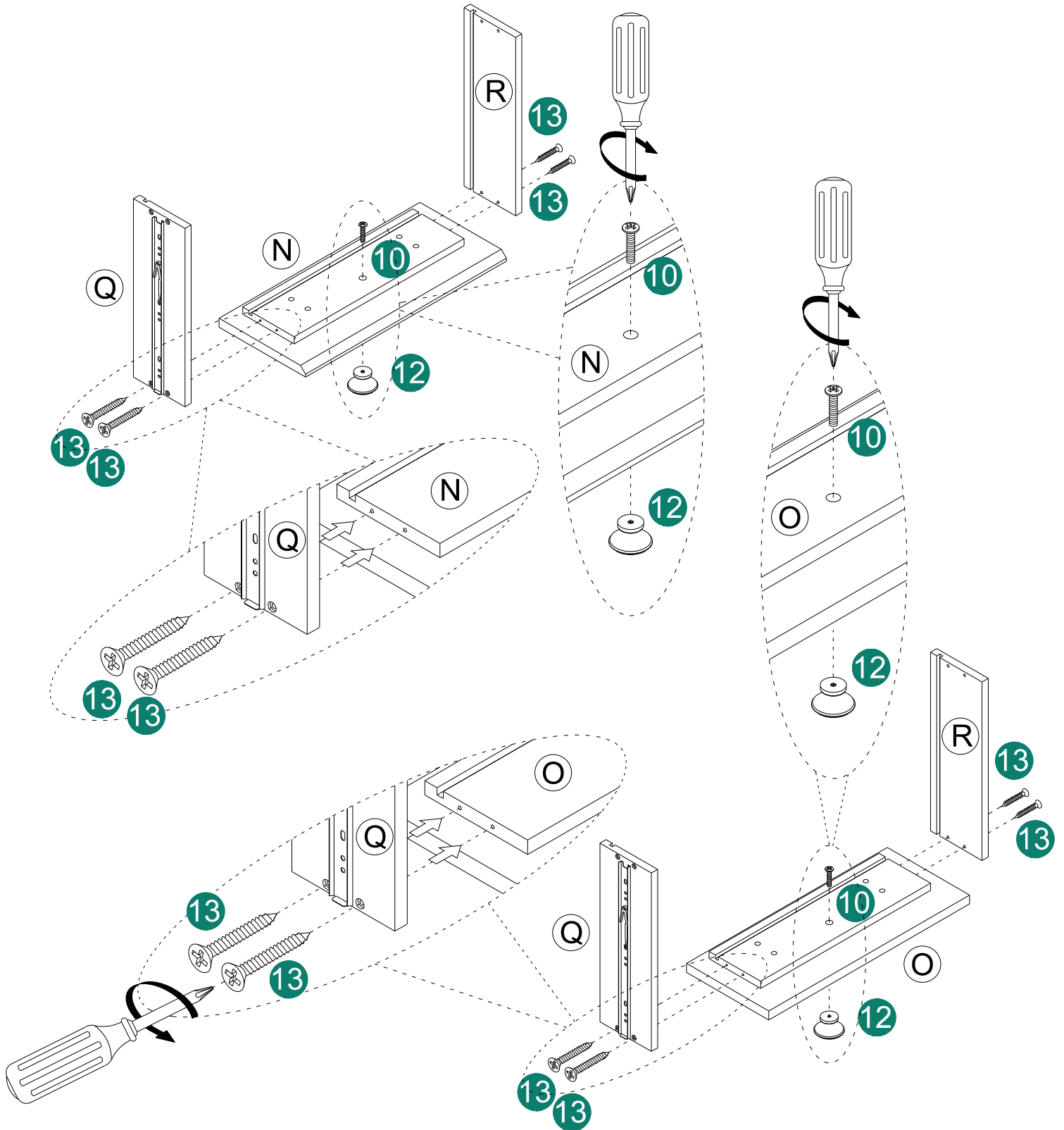

ASSEMBLY INSTRUCTIONS

11

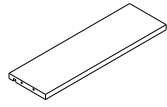

P 3pc

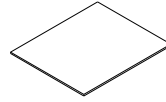

S 3pc



13 12pcs

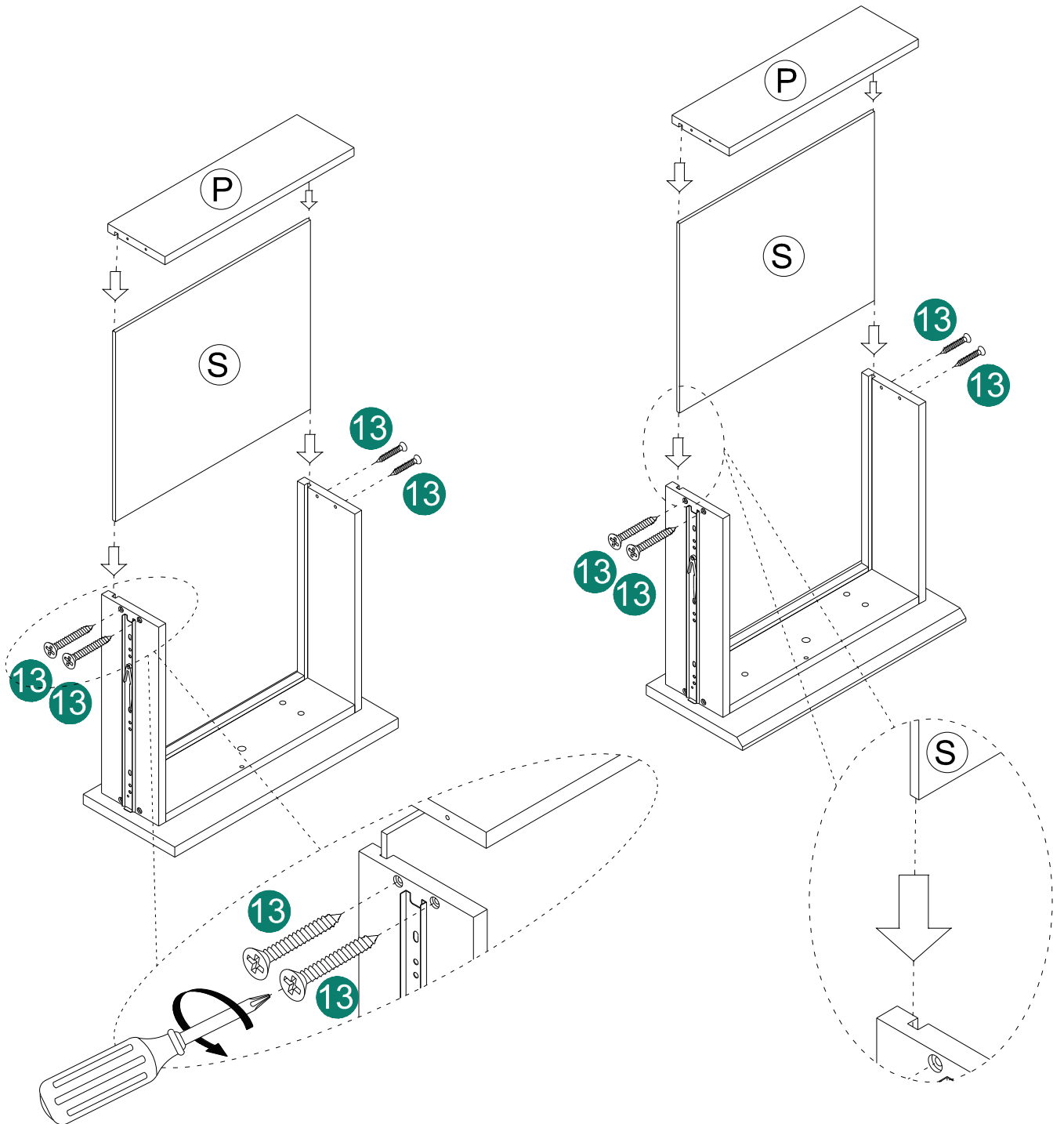

ASSEMBLY INSTRUCTIONS

12



⑦ 16pcs

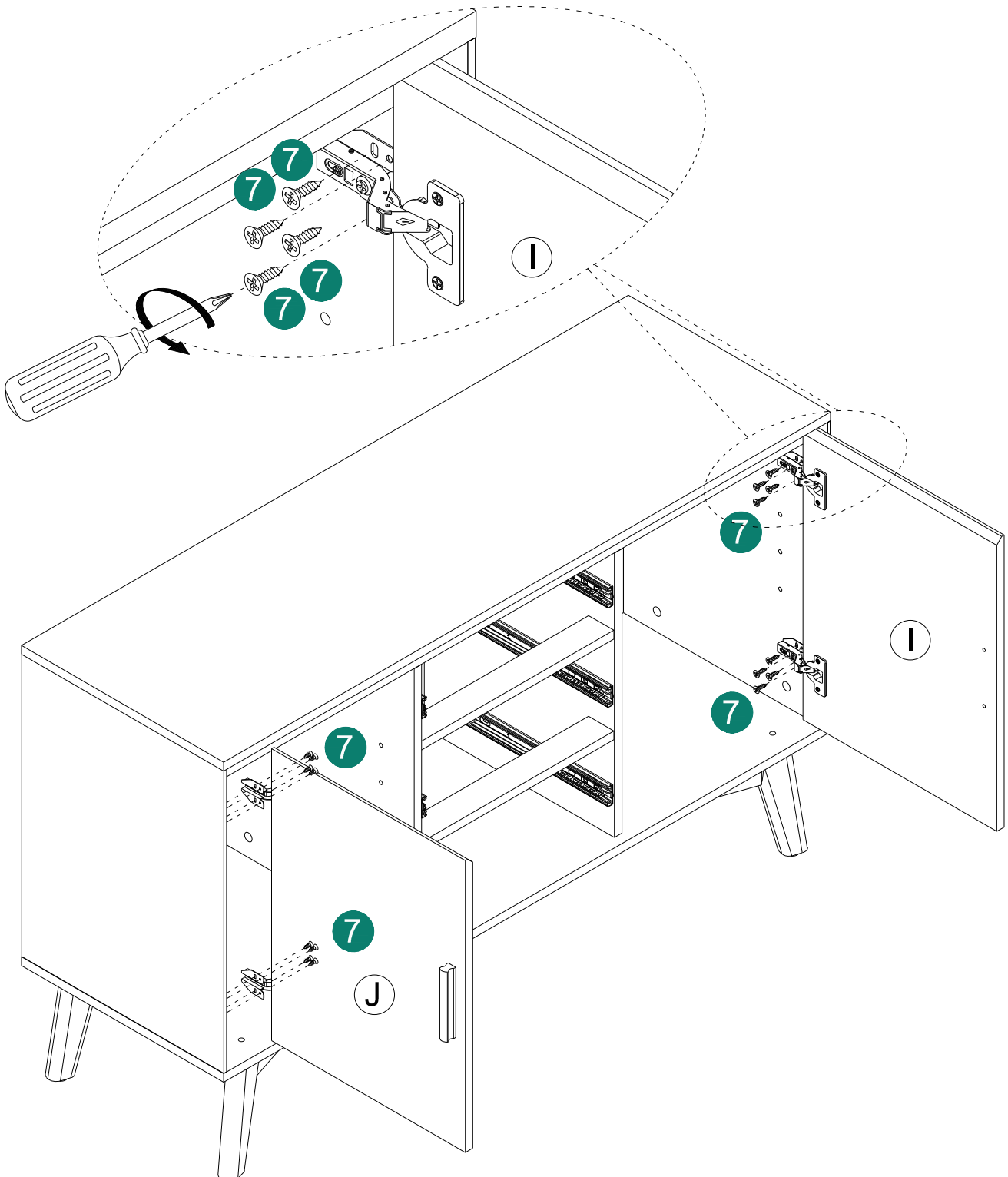

ASSEMBLY INSTRUCTIONS

13

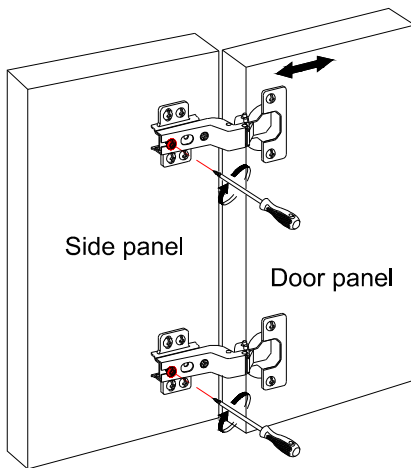

①

Front-to-Back Direction Adjustment:

Rotate the screws on the door hinges shown in the image. The door panel can be moved front-back.

Adjustment range: 4mm

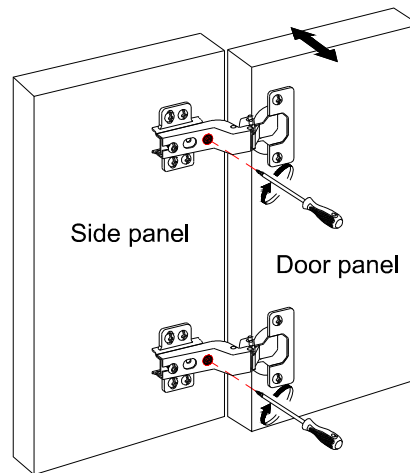

②

Left-Right Direction Adjustment:

Rotate the screws on the door hinges shown in the image. The door panel can be moved left-right.

Adjustment range: 3mm

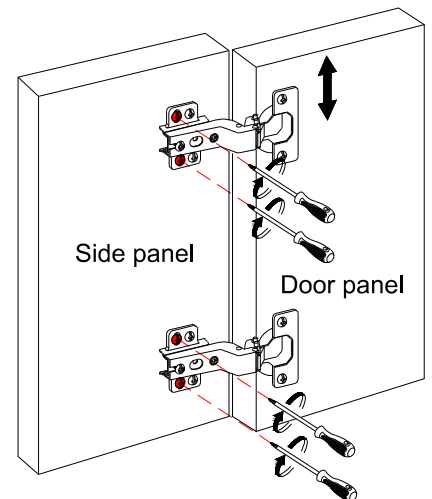

③

Up-Down Direction Adjustment:

Rotate the screws on the door hinges shown in the image. The door panel can be moved up-down.

Adjustment range: 4mm

ASSEMBLY INSTRUCTIONS

14

Common Door Panel Issues:

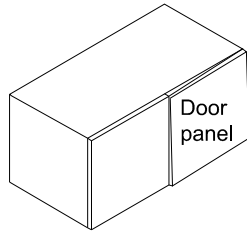

Door panel is not straight

Adjust the door hinges

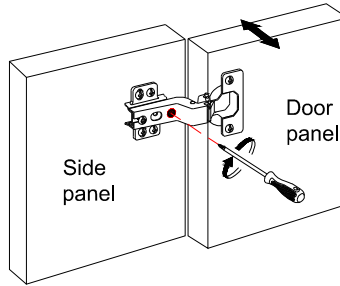

Finished

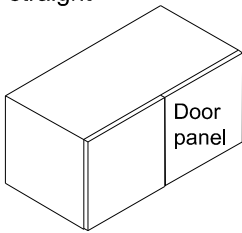
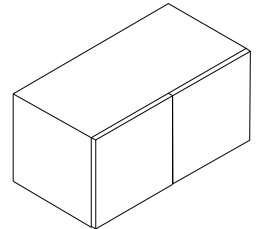

The gap between door panels is too large

Adjust the door hinges

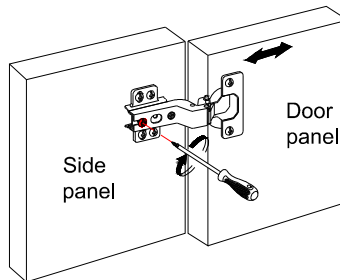
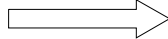

Finished

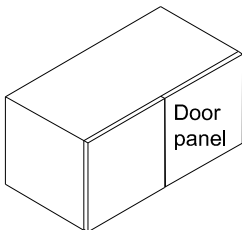
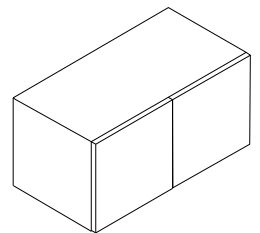
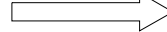

The door panels are not coplanar

Adjust the door hinges

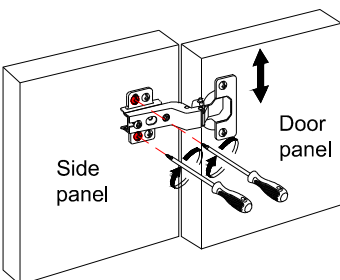
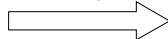

Finished

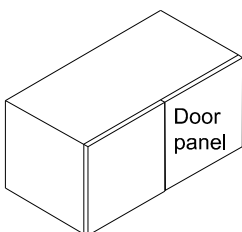
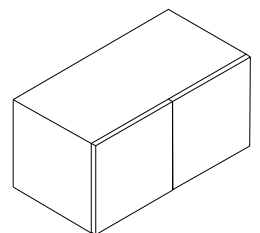
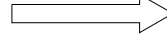

The two door panels are not at the same height

Adjust the door hinges

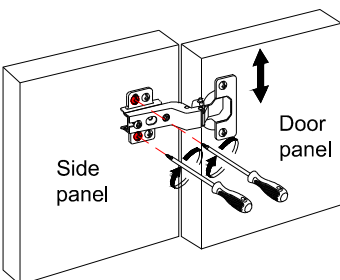
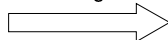

Finished

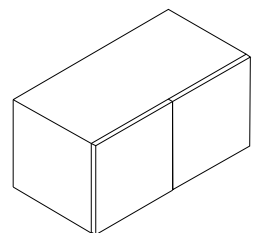
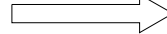

ASSEMBLY INSTRUCTIONS

15

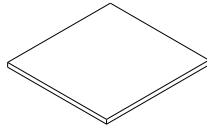

C 2pc



9 8pcs

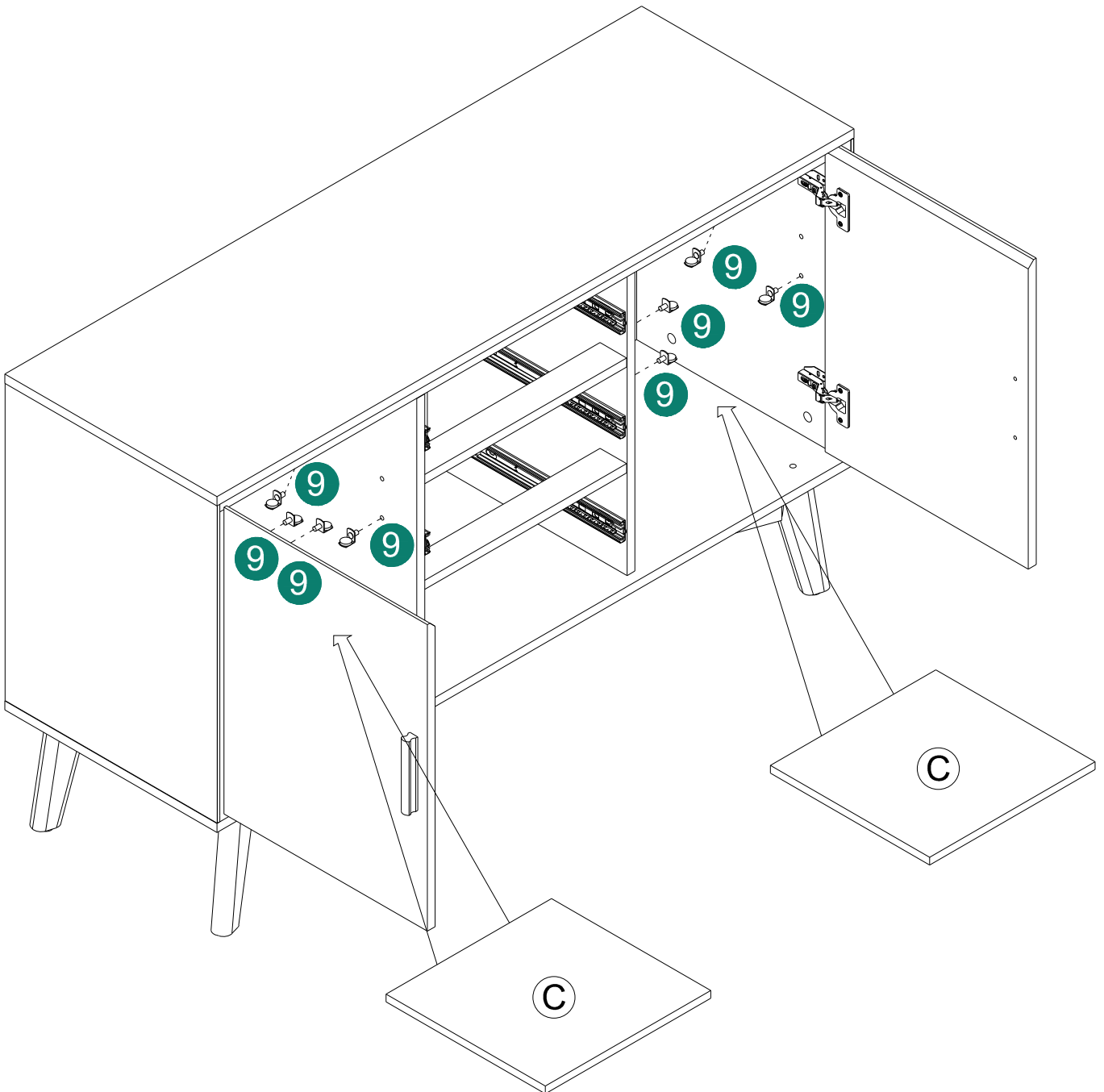

ASSEMBLY INSTRUCTIONS

16

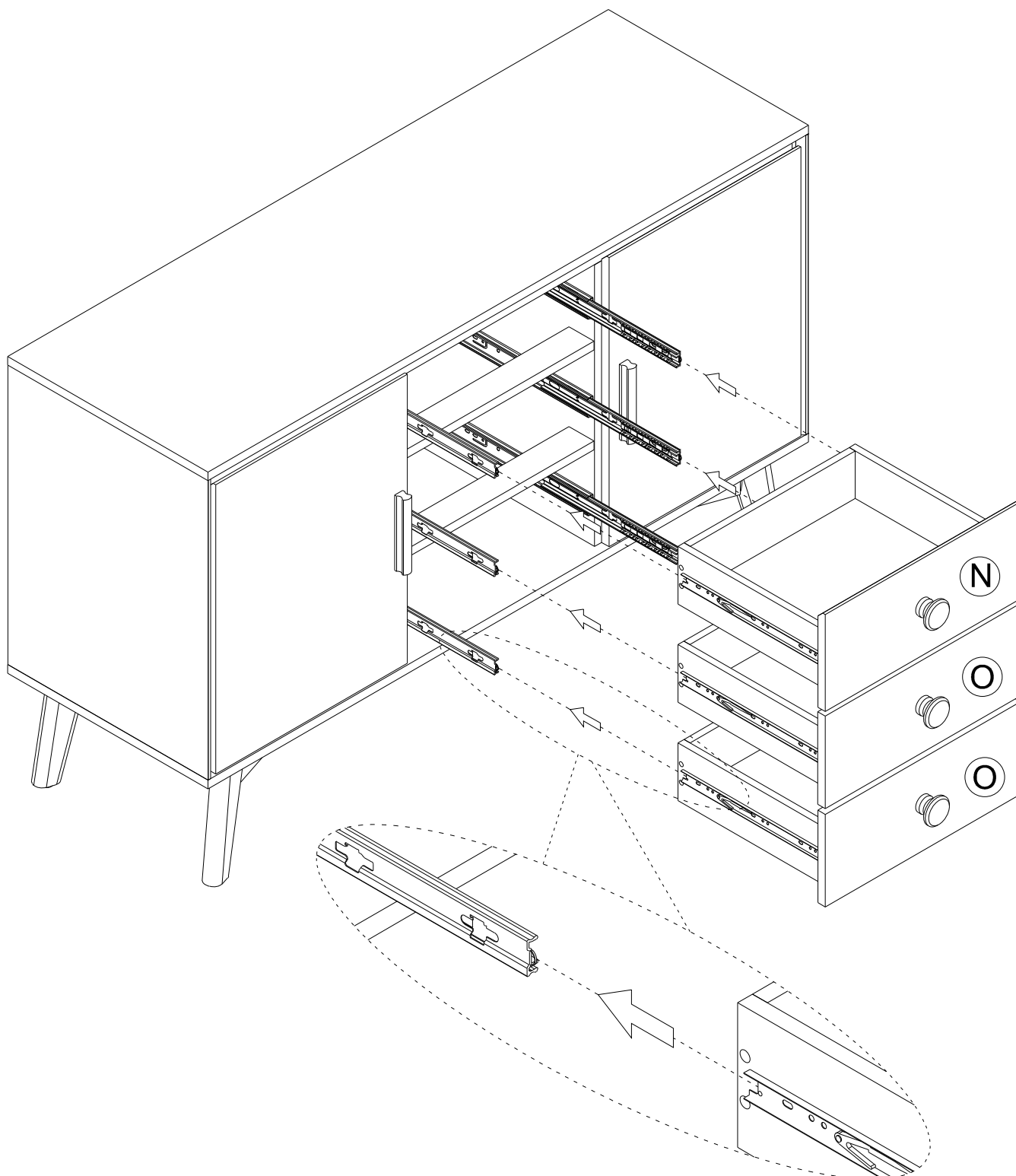

ASSEMBLY INSTRUCTIONS

17

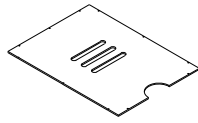

T 1pc

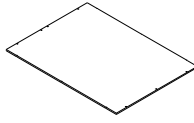

U 1pc

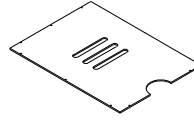

V 1pc



4 26pcs

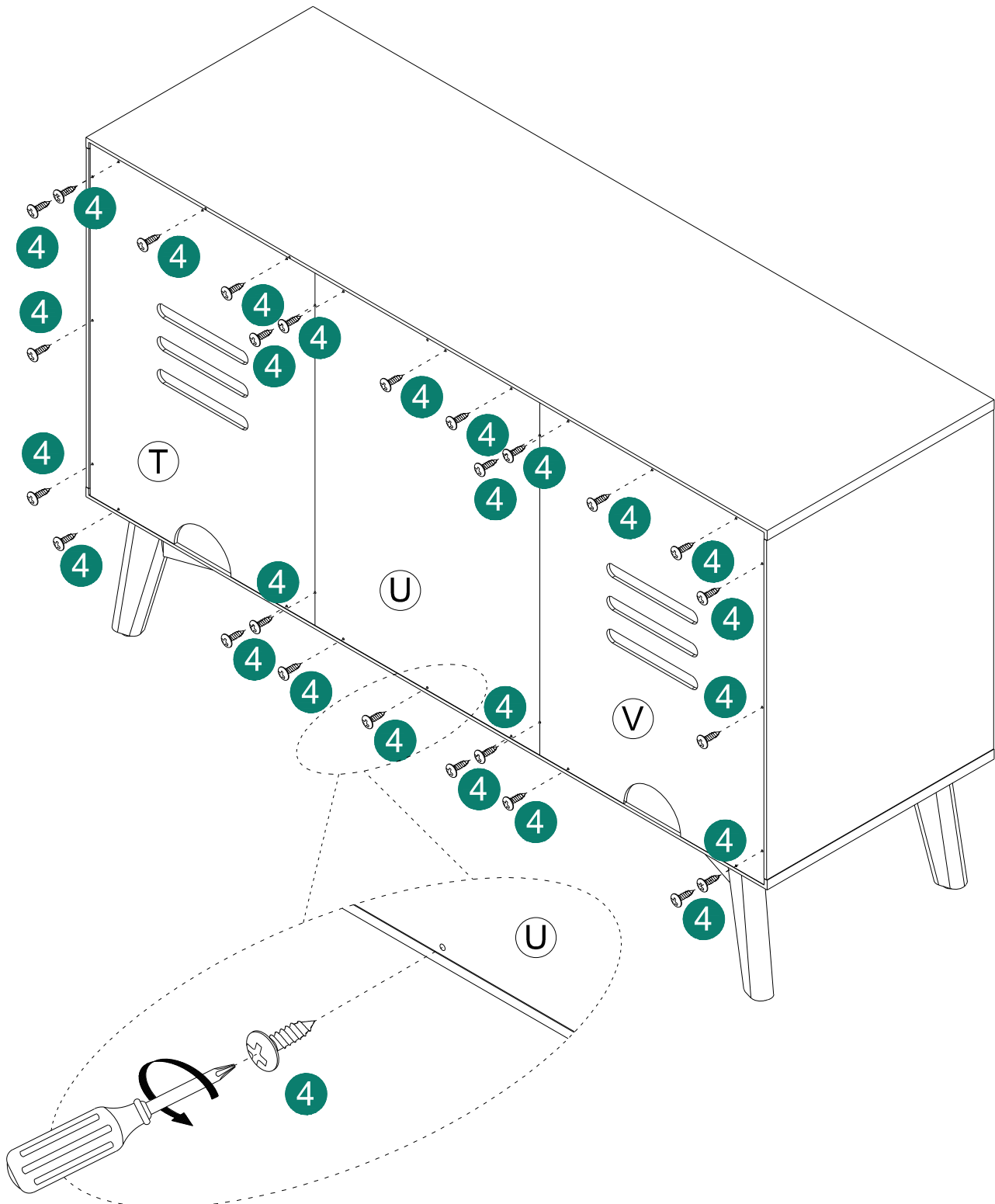

ASSEMBLY INSTRUCTIONS

18

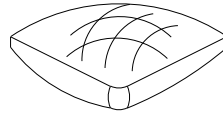

14 1set

A

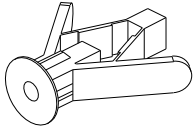

1pcs

B

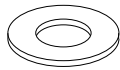

2pcs

C

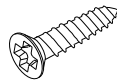

Ø8*3/4"

1pcs

D

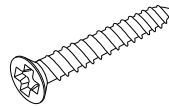

Ø8*1-1/2"

1pcs

E

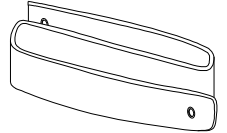

1pcs

WALL

