

# WOOD SWIVEL STOOL

Counter Stool  
Bar Stool







Examine all packaging material for small parts that may have come loose during shipment. Periodic checks are recommended to insure that all components are in proper position, tight and free from damage. Keep this assembly instruction for future reference. Adult assembly is required.

## HARDWARE LIST

- A (6) 1/4" Spring Washers
- B (6) 1/4" Flat Washers
- C (2) 1/4" x 1-1/4" Allen Bolts
- D (4) 1/4" x 1" Allen Bolts
- E (2) 8 x 1-1/2" Screws
- F (1) 1/4" Allen Wrench

## PARTS LIST

- G (1) Backrest and Cushion Seat
- H (1) Left Armrest
- I (1) Right Armrest
- (J) (1) Base

PART	QTY	HARDWARE	PART	QTY	HARDWARE
A	6		B	6	
C	2		D	4	
E	2		F	1	

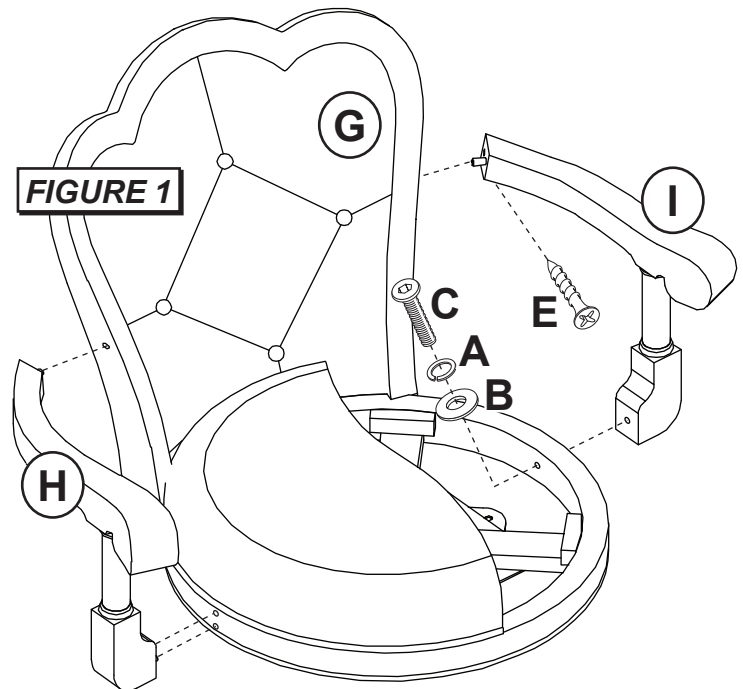
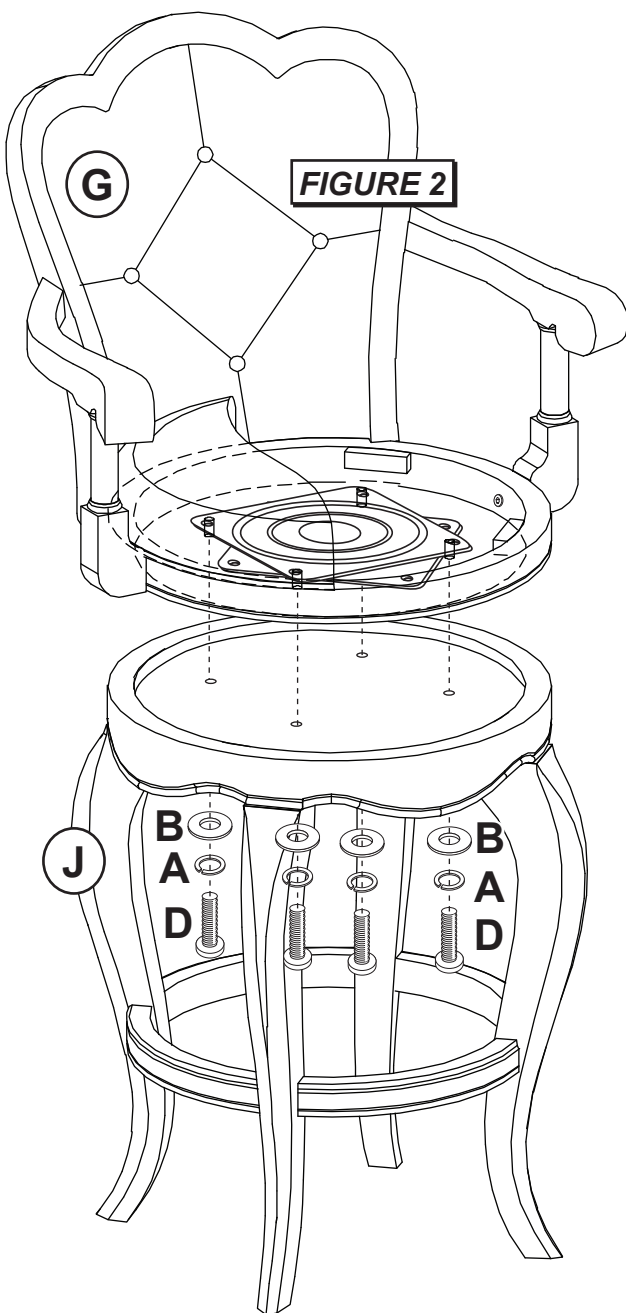

### STEP 1

Begin assembly by attaching the Right Armrest (I) to the Backrest and Cushion Seat (G) using 1 Allen Bolt (C), 1 Spring Washer (A) and 1 Flat Washer (B) from the bottom and 1 Screw (E) at the top. Repeat step 1 to attach the Left Armrest (H) to the Backrest and Cushion Seat (G). See **Figure 1**.

### STEP 2

Next line up the holes of the Backrest and Cushion Seat (G) with the holes of the Base (J). Secure with 4 Allen Bolts (D), 4 Spring Washers (A) and 4 Flat Washers (B). See **Figure 2**. Tighten all bolts with the Allen Wrench (D) provided. The assembly is now complete.

**CARE & MAINTENANCE:** The touch of a soft cloth is all the maintenance the finish will ever need. Please do not use harsh or abrasive cleaners for polishing, as they may cause damage to the finish. Periodic checks are recommended to make sure that all bolts, screws and nuts are securely tightened.