

# ASSEMBLY INSTRUCTION

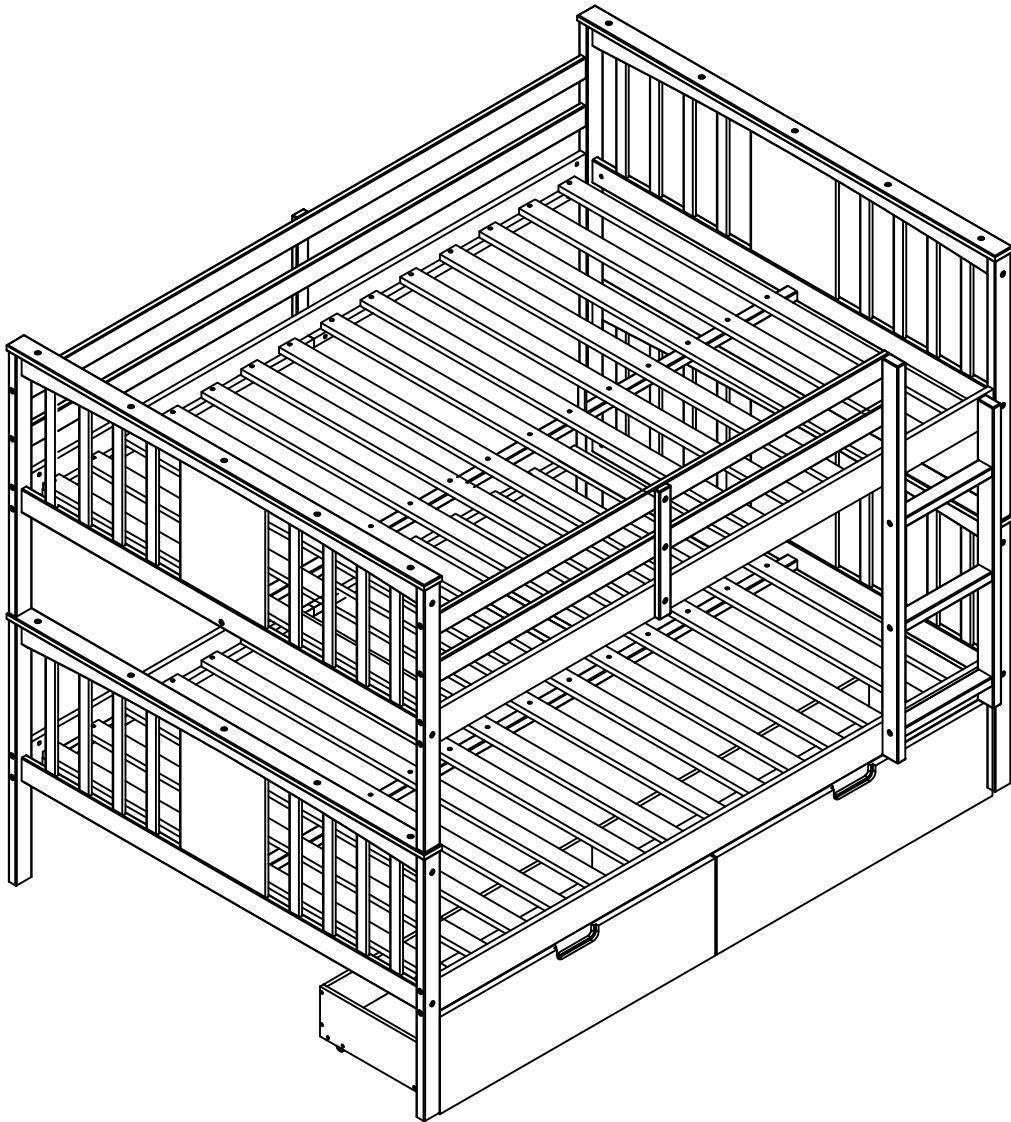



# SAFETY WARNINGS



1. This bed is designed for use only mattress(es) meeting the following specifications on the upper bunk and lower bunk:

Upper bunk (bunk bed and tribed included)

<b>Bed Type</b>	<b>Length</b>	<b>Width</b>	<b>Thickness</b>
Full Standard	74"-75"	53" - 54"	6" max

Lower bunk







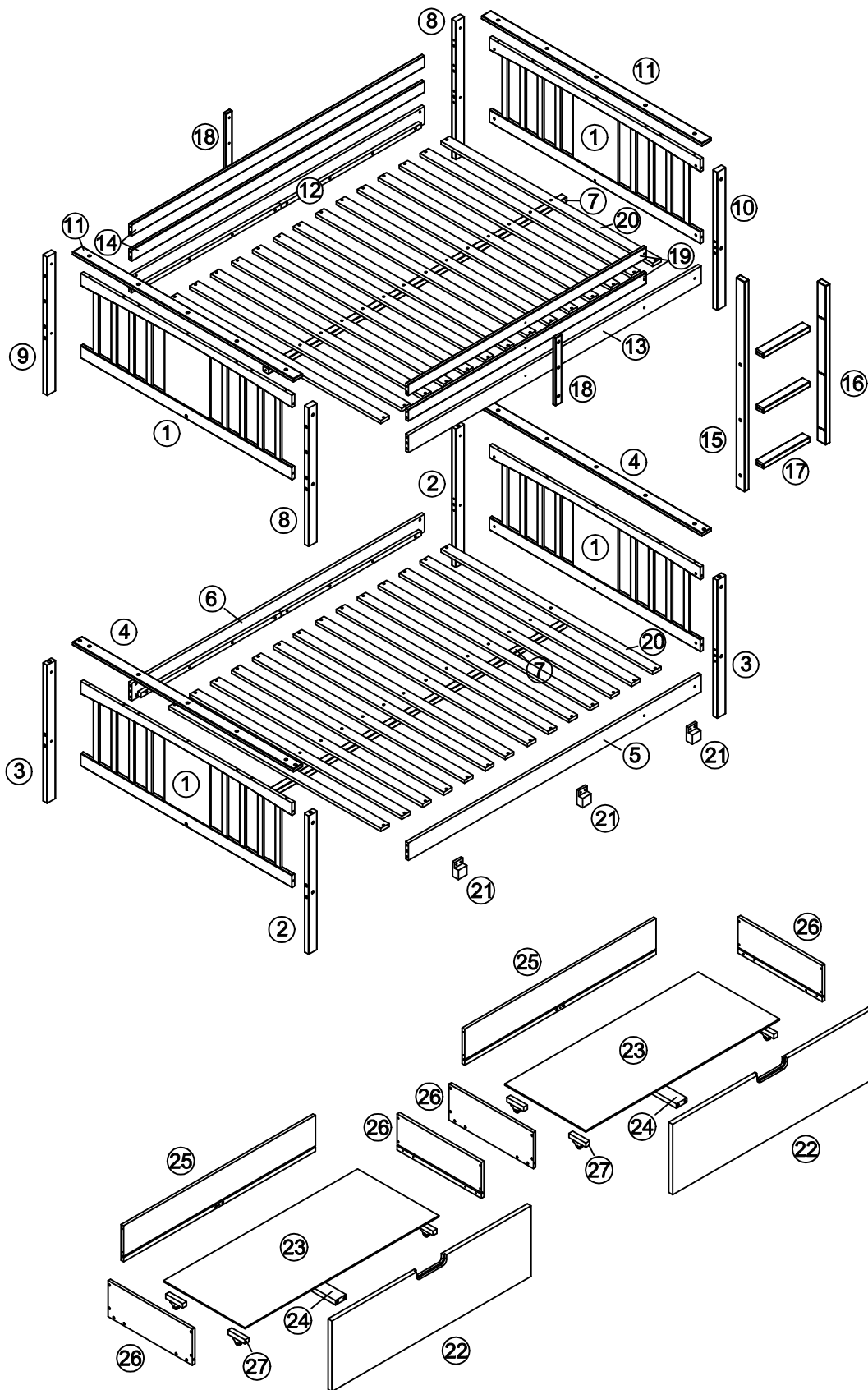

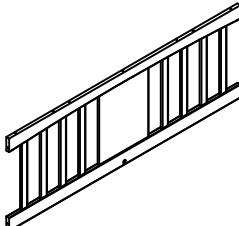
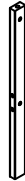

<b>Bed Type</b>	<b>Length</b>	<b>Width</b>	<b>Thickness</b>
Full Standard	74"-75"	53" - 54"	8"

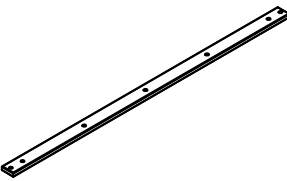
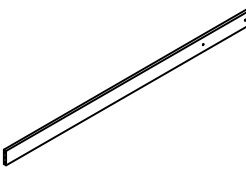
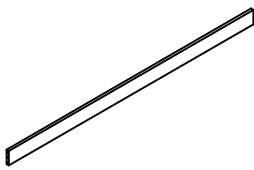
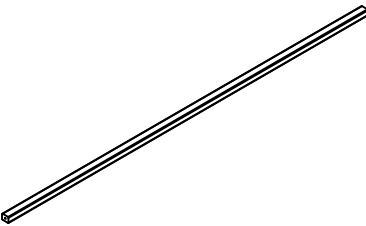
2. Replacement parts, including additional guardrails, maybe obtained from any of our (GIGACLOUD TECHNOLOGY (USA) INC. 18961 ARENTH AVENUE CITY OF INDUSTRY, CA, 91748) dealers.
3. Follow the information on the warnings appearing on the upper bunk bed end structure and on the carton. Do not remove warning label from bed.
4. Always use the recommended size mattresses or mattress supports, or both, to help prevent the likelihood of entrapment or falls.
5. Surface of the mattress must be at least 5' (127 mm) below the upper edge of guardrails.
6. Do not allow children under 6 years of age to use the upper bunk.
7. Periodically check and ensure that the guardrail, ladder, and other components are in their proper position, free from damage, and that all connectors are tight.
8. Do not allow horseplay on or under the bed and prohibit jumping on the bed
9. Always use the ladder for entering and leaving the upper bunk.
10. Do not use substitute parts. Contact the manufacturer or dealer for replacement parts.
11. Use of a night light may provided added safety precaution for a child using the upper bunk.
12. Always use guardrails on both long sides of the upper bunk. If the bunk bed will be placed next to the wall, the guardrail that runs the full length of the bed should be placed against the wall to prevent entrapment between the bed and wall.
13. The use of water or sleep flotation mattresses is prohibited.
14. STRANGULATION HAZARD – Never attach or hang items to any part of the bunk bed that are not designed for use with the bed; for example, but not limited to, hook, belts and jump ropes.
15. Keep these instructions for future reference
16. Prohibit more than one person on upper bunk.
17. We recommend assembling your bunk bed on the shipping carton to protect your floor or carpet.
18. Be certain all staples are out of the box before beginning assembly on the shipping carton.

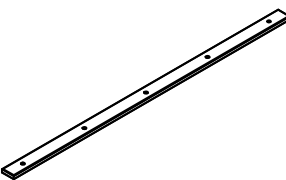
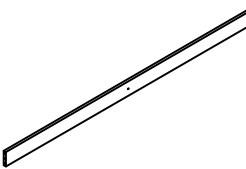
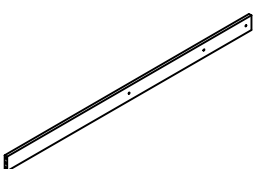
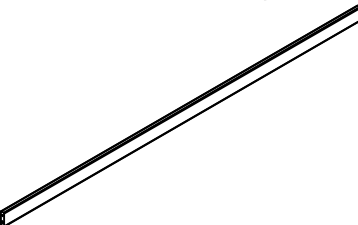

# Detail View - FULL BED WITH 2 DRAWERS







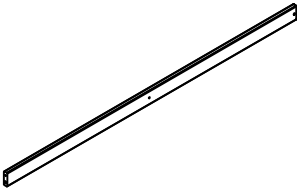
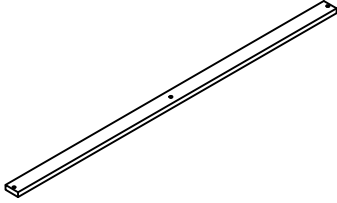
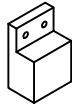
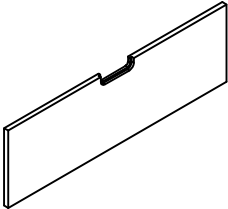
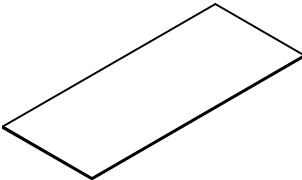
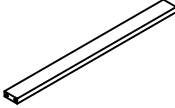
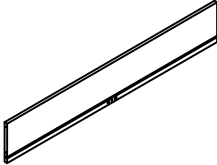
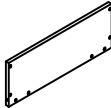



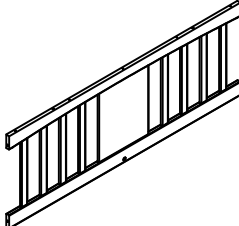

# Part List

<p>1 : Side Frame - 4pcs</p> 	<p>2 : Left Front &amp; Right Back Post Of Bottom Bed - 2pcs</p> 	<p>3 : Left Back &amp; Right Front Post Of Bottom Bed - 2pcs</p> 
<p>4 : Cap Of Bottom Bed - 2pcs</p> 	<p>5 : Front Rail Of Bottom Bed - 1pc</p> 	<p>6 : Back Rail Of Bottom Bed - 1pc</p> 
<p>7 : Middle Rail - 2pcs</p> 	<p>8 : Left Front &amp; Right Back Post Of Upper Bed - 2pcs</p> 	<p>9 : Left Back Post Of Upper Bed - 1pc</p> 
<p>10 : Right Front Post Of Upper Bed - 1pc</p> 	<p>11 : Cap Of Upper Bed - 2pcs</p> 	<p>12 : Back Rail Of Upper Bed - 1pc</p> 
<p>13 : Front Rail Of Upper Bed - 1pc</p> 	<p>14 : Back Guard Rail - 2pcs</p> 	<p>15 : Left Ladder Column - 1pc</p> 
<p>16 : Right Ladder Column - 1pc</p> 	<p>17 : Step Of Bed Ladder - 3pcs</p> 	<p>18 : Support Timber - 2pcs</p> 

# Part List

<p>19 : Front Guard Rail - 2pcs</p> 	<p>20 : Slat For Bed - 28pcs</p> 	<p>21 : Drawers Stopper -3pcs</p> 
<p>22 : Front Panel Of Drawer -2Pcs</p> 	<p>23 : Bottom Panel Of Drawer -2Pcs</p> 	<p>24 : Crossprece - 2pcs</p> 
<p>25 : Back Panel Of Drawer -2Pcs</p> 	<p>26 : Side Panel Of Drawer -4Pcs</p> 	<p>27 : Wheels - 8pcs</p> 

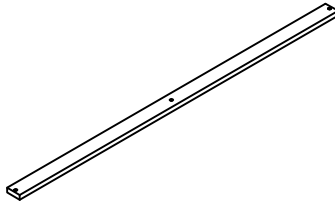
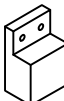
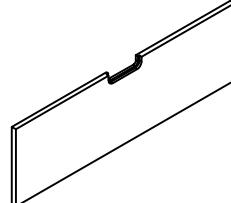
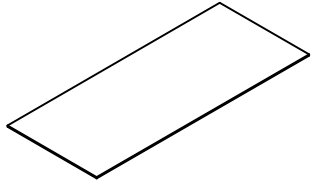
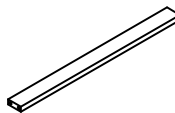
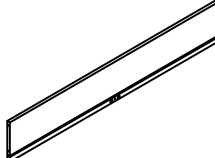
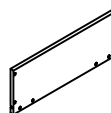





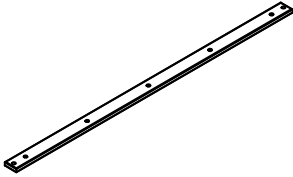
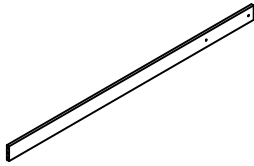
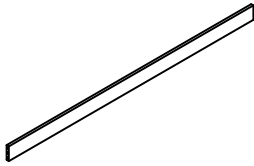
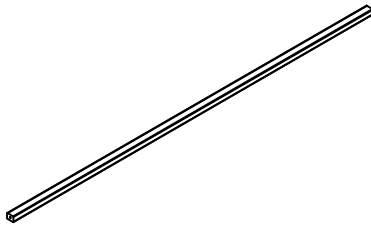
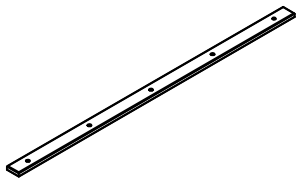
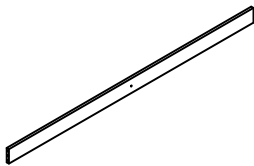
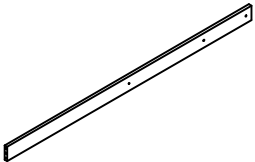
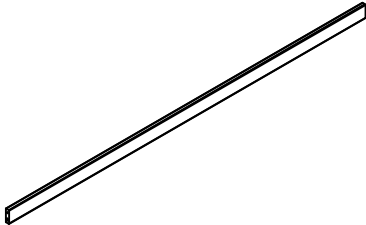
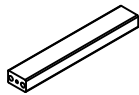
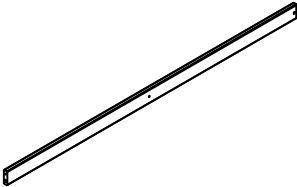





# Part List -

<p>1 : Side Frame - 4pcs</p> 	<p>2 : Left Front &amp; Right Back Post Of Bottom Bed - 2pcs</p> 	<p>3 : Left Back &amp; Right Front Post Of Bottom Bed - 2pcs</p> 
<p>8 : Left Front &amp; Right Back Post Of Upper Bed - 2pcs</p> 	<p>9 : Left Back Post Of Upper Bed - 1pc</p> 	<p>10 : Right Front Post Of Upper Bed - 1pc</p> 
<p>15 : Left Ladder Column - 1pc</p> 	<p>16 : Right Ladder Column - 1pc</p> 	<p>18 : Support Timber - 2pcs</p> 
<p>20 : Slat For Bed - 28pcs</p> 	<p>21 : Drawers Stopper -3Pcs</p> 	<p>22 : Front Panel Of Drawer -2Pcs</p> 
<p>23 : Bottom Panel Of Drawer -2Pcs</p> 	<p>24 : Crossprece - 2pcs</p> 	<p>25 : Back Panel Of Drawer -2Pcs</p> 
<p>26 : Side Panel Of Drawer -4Pcs</p> 	<p>27 : Wheels - 8pcs</p> 	

## Part List -

<p>4 : Cap Of Bottom Bed - 2pcs</p> 	<p>5 : Front Rail Of Bottom Bed - 1pc</p> 	<p>6 : Back Rail Of Bottom Bed - 1pc</p> 
<p>7 : Middle Rail - 2pcs</p> 	<p>11 : Cap Of Upper Bed - 2pcs</p> 	<p>12 : Back Rail Of Upper Bed - 1pc</p> 
<p>13 : Front Rail Of Upper Bed - 1pc</p> 	<p>14 : Back Guard Rail - 2pcs</p> 	<p>17 : Step Of Bed Ladder - 3pcs</p> 
<p>19 : Front Guard Rail - 2pcs</p> 		

# Hardware List -

<p>A : Wood Dowel - 42pcs</p>  <p>Ø10x40mm</p>	<p>B : Wood Dowel - 4pcs</p>  <p>Ø14x100mm</p>	<p>C : Hex - Head Screw - 6pcs</p>  <p>Ø6.2x30mm</p>
<p>D : Hex - Head Screw - 30pcs</p>  <p>Ø6.2x30mm</p>	<p>E : Hex - Head Screw - 6pcs</p>  <p>Ø6.2x50mm</p>	<p>F : Horizontal-Hole Bolts - 6pcs</p>  <p>Ø6.2x70mm</p>
<p>G : Hex - Head Bolts - 16pcs</p>  <p>Ø1/4"x57mm</p>	<p>H : Hex - Head Bolts - 16pcs</p>  <p>Ø1/4"x70mm</p>	<p>I : Hinge - 32pcs</p>  <p>Ø1/4"xØ10x12.5mm</p>
<p>J : Round Head Screw - 100pcs</p>  <p>Ø4x30mm</p>	<p>N : Round Head Screw - 24pcs</p>  <p>Ø4x25mm</p>	<p>Z : Allen Wrench - 1pc</p>  <p>4mm</p>

# Step: 1

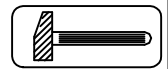
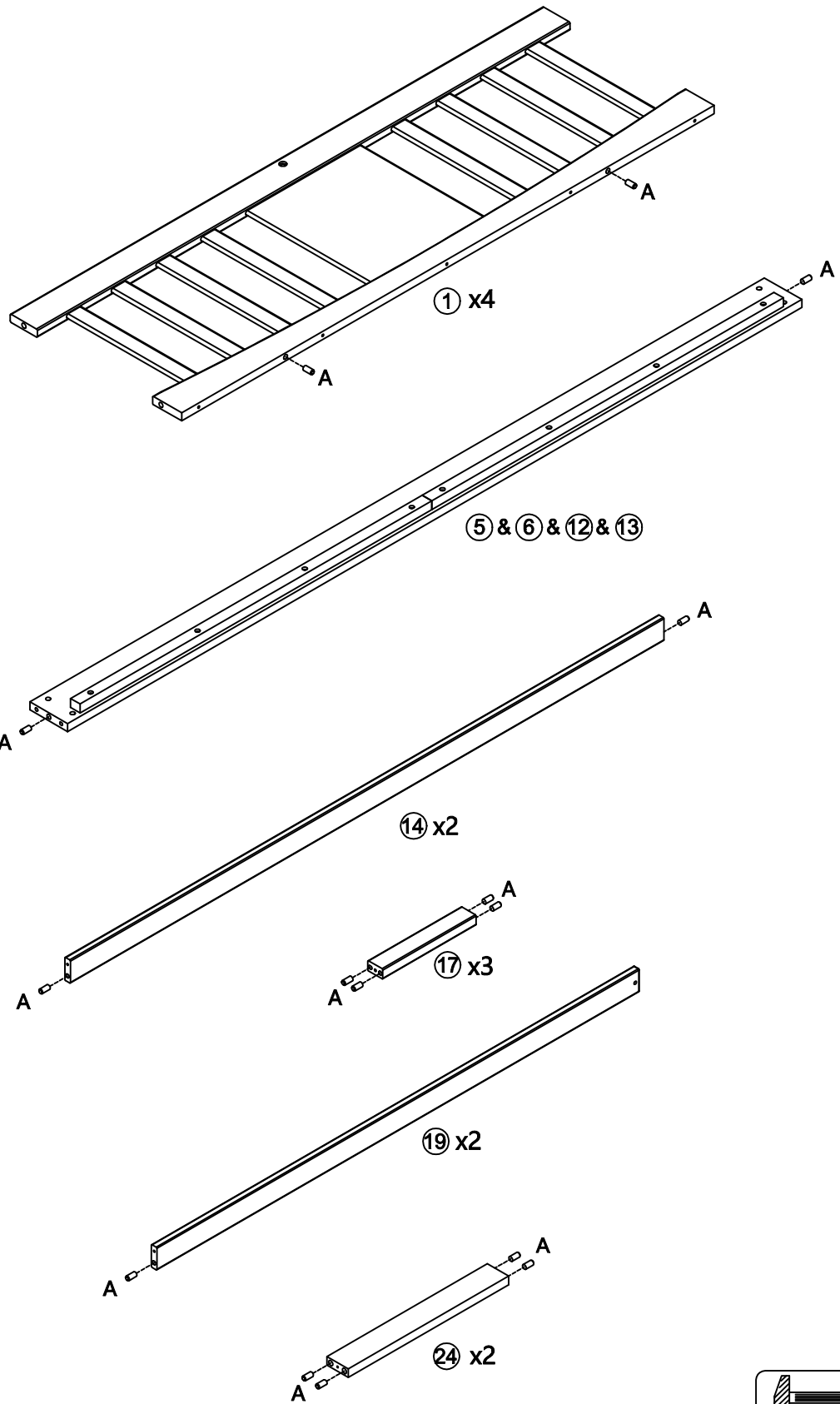

<b>A</b>		Qty <b>42</b>
----------	--	------------------

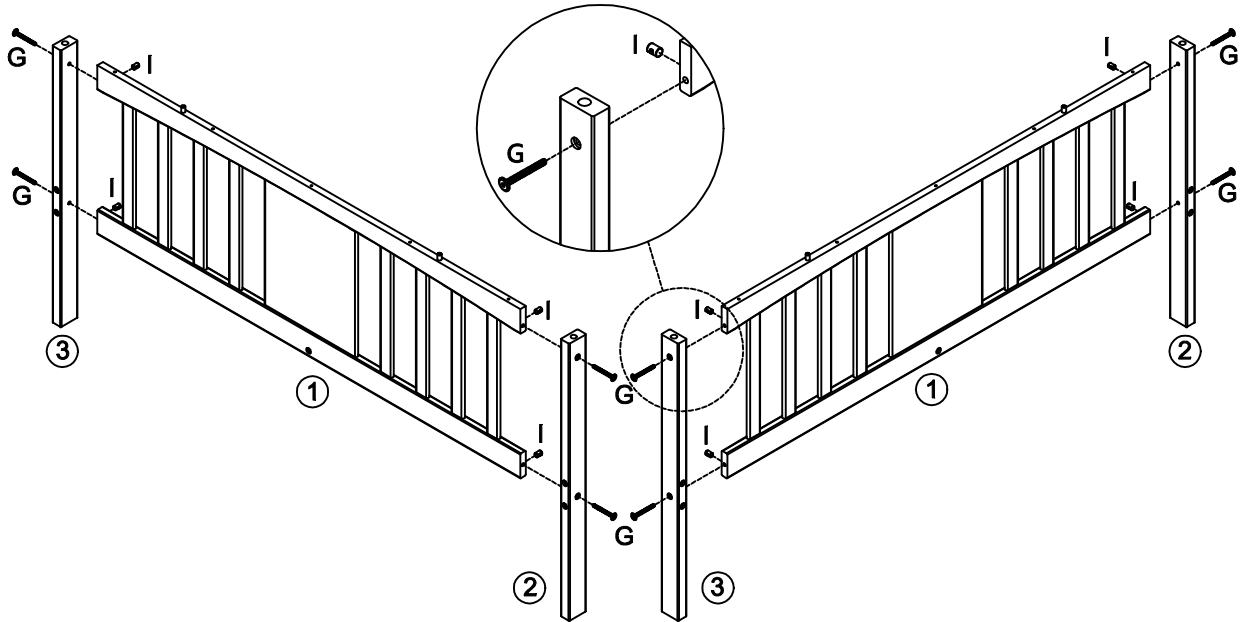

## Step: 2

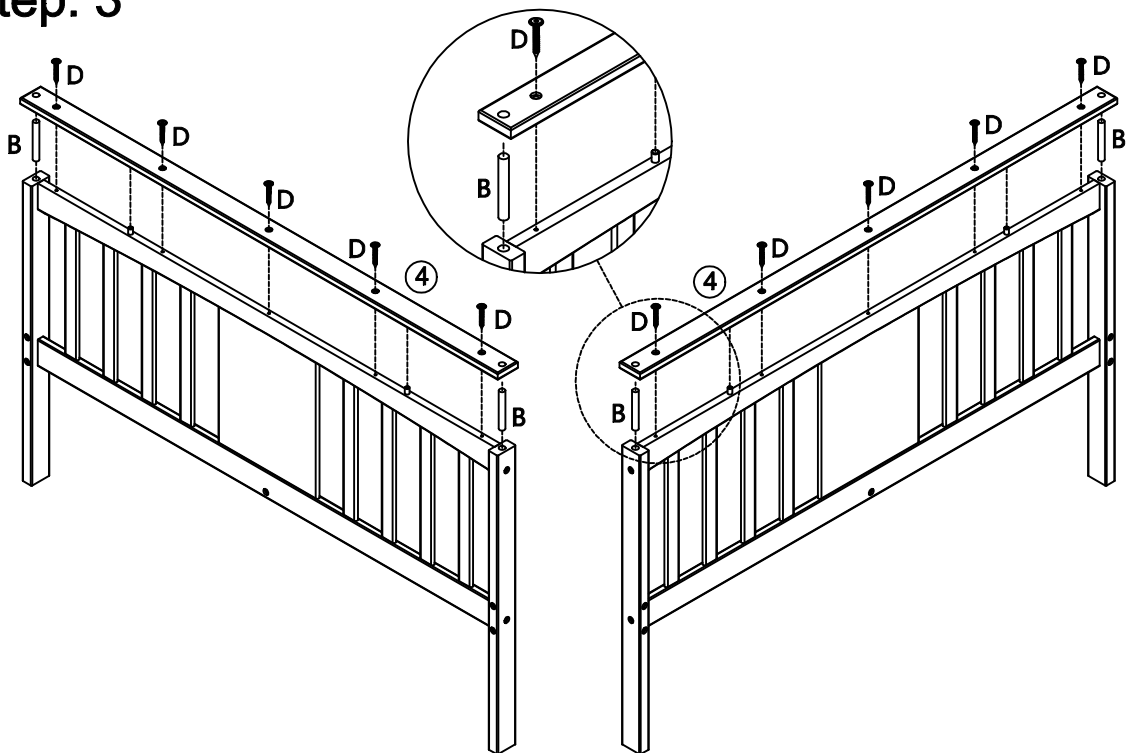

<b>G</b>		Qty <b>08</b>	<b>I</b>		Qty <b>08</b>	<b>Z</b>		Qty <b>01</b>
----------	---	------------------	----------	---	------------------	----------	---	------------------

## Step: 3



<b>B</b>		Qty <b>04</b>	<b>D</b>		Qty <b>10</b>	<b>Z</b>		Qty <b>01</b>
----------	---	------------------	----------	--	------------------	----------	---	------------------

# Step: 4

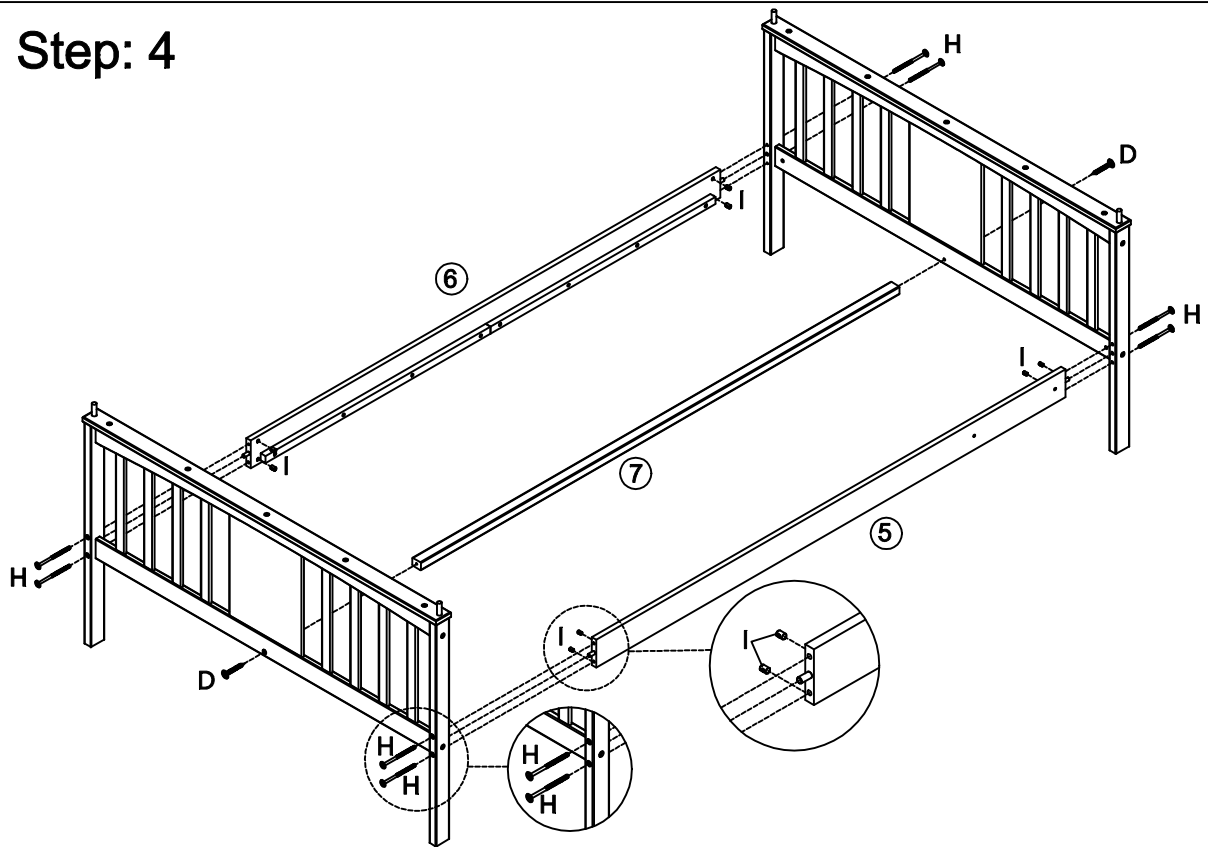

D		Qty 02	H		Qty 08	I		Qty 08	Z		Qty 01
---	---	-----------	---	---	-----------	---	---	-----------	---	---	-----------

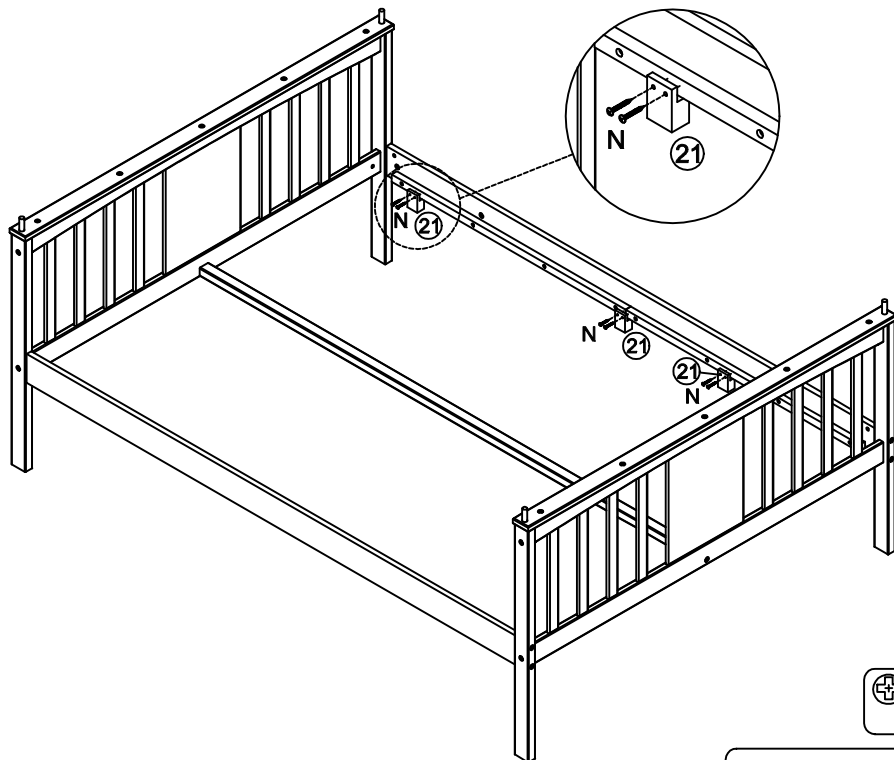

# Step: 5

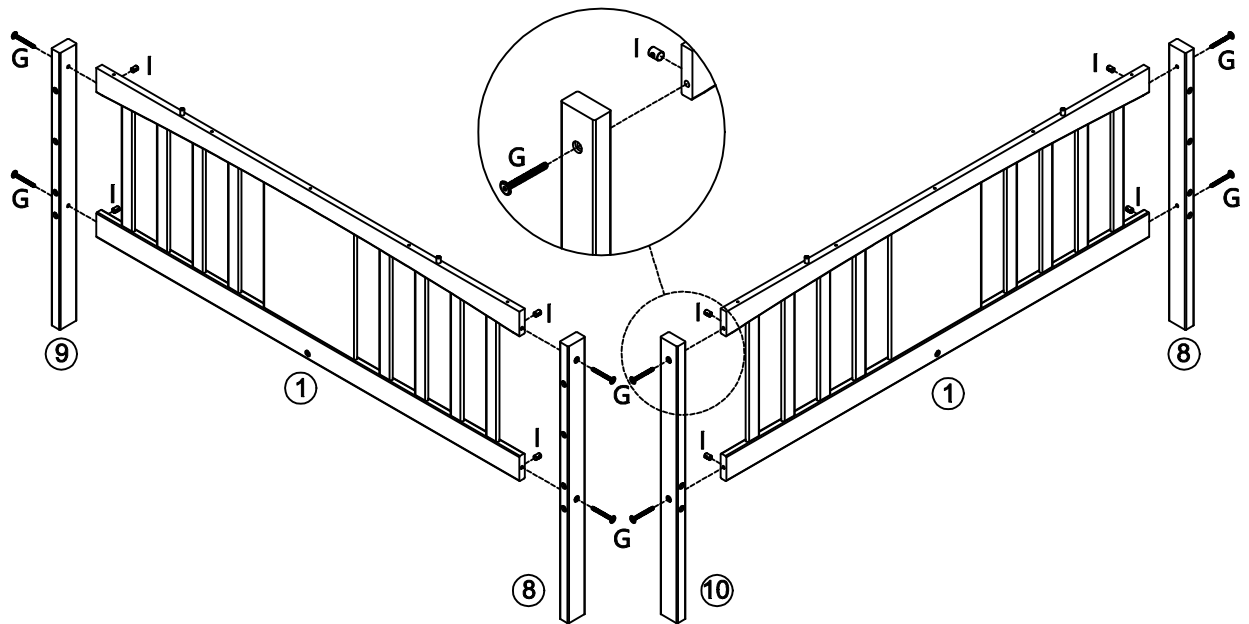

		Qty 06
--	---	-----------

## Step: 6



G		Qty 08	I		Qty 08	Z		Qty 01
---	---	-----------	---	---	-----------	---	---	-----------

## Step: 7

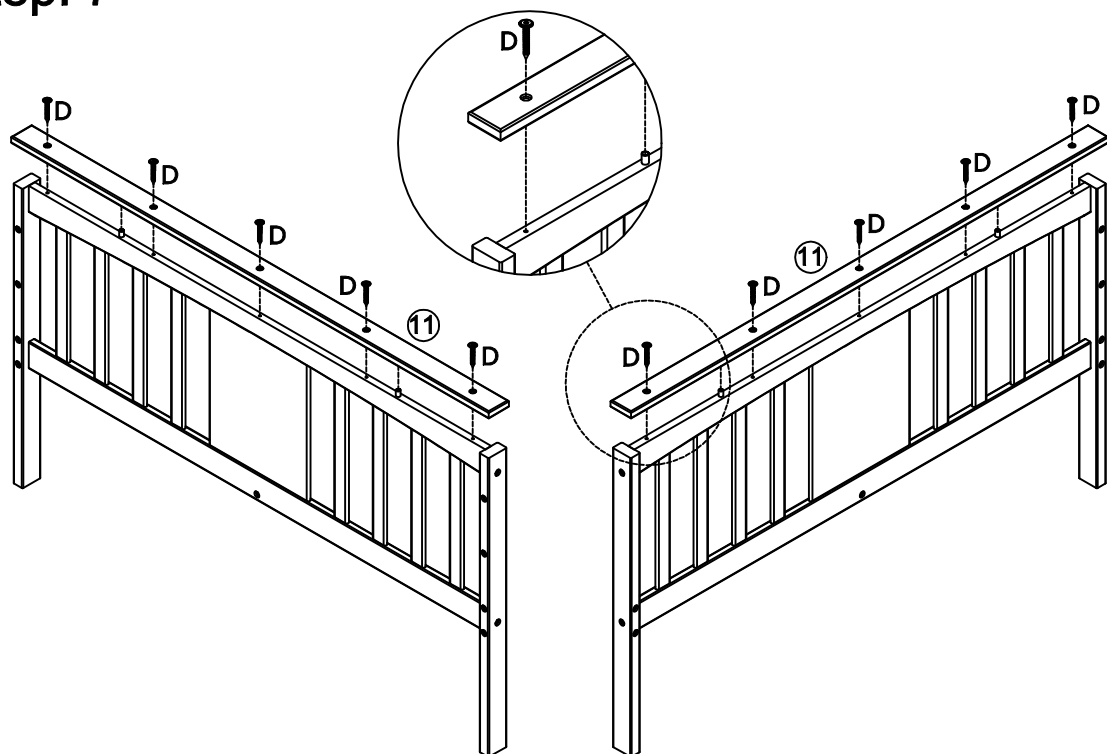

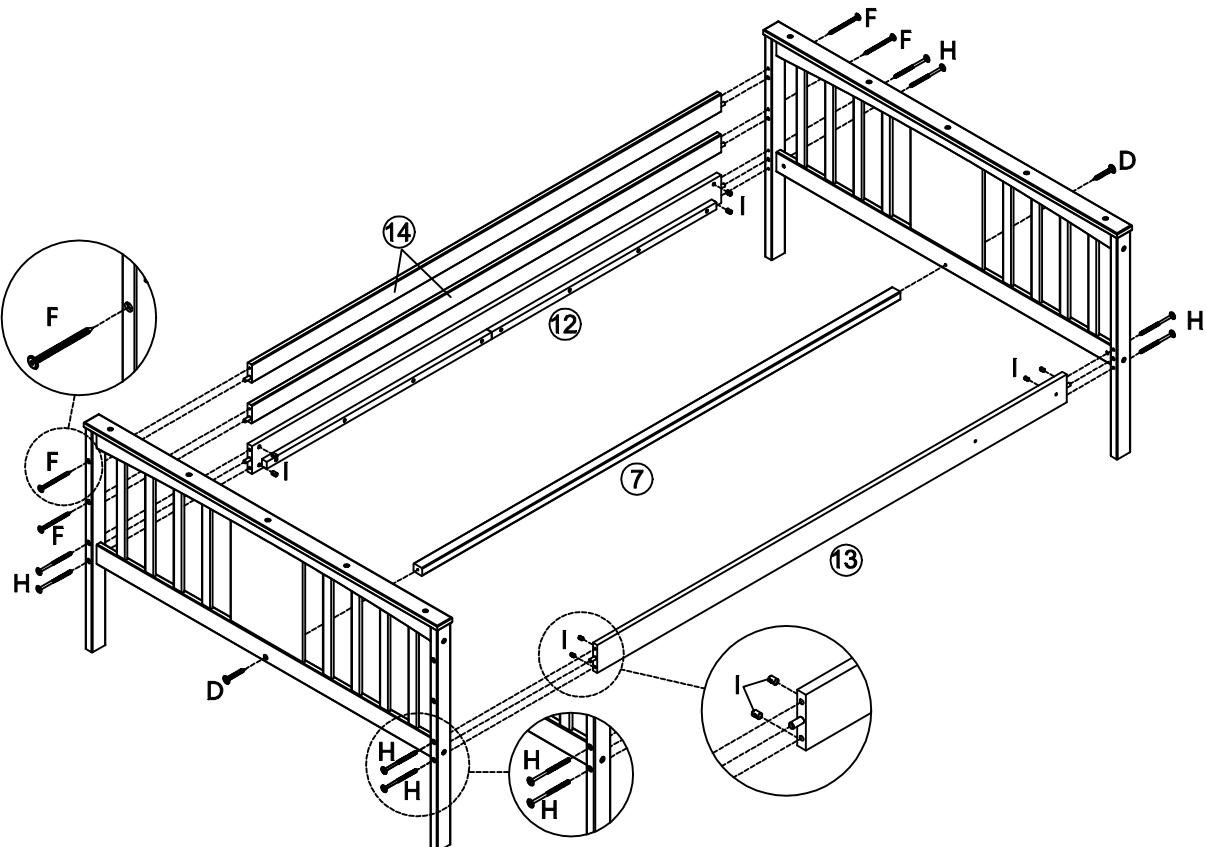

D		Qty 10	Z		Qty 01
---	--	-----------	---	---	-----------

# Step: 8



**D**  Qty **02**

**F**  Qty **04**

**H**  Qty **08**

**Z**  Qty **05**

**I**  Qty **08**

Step: 9

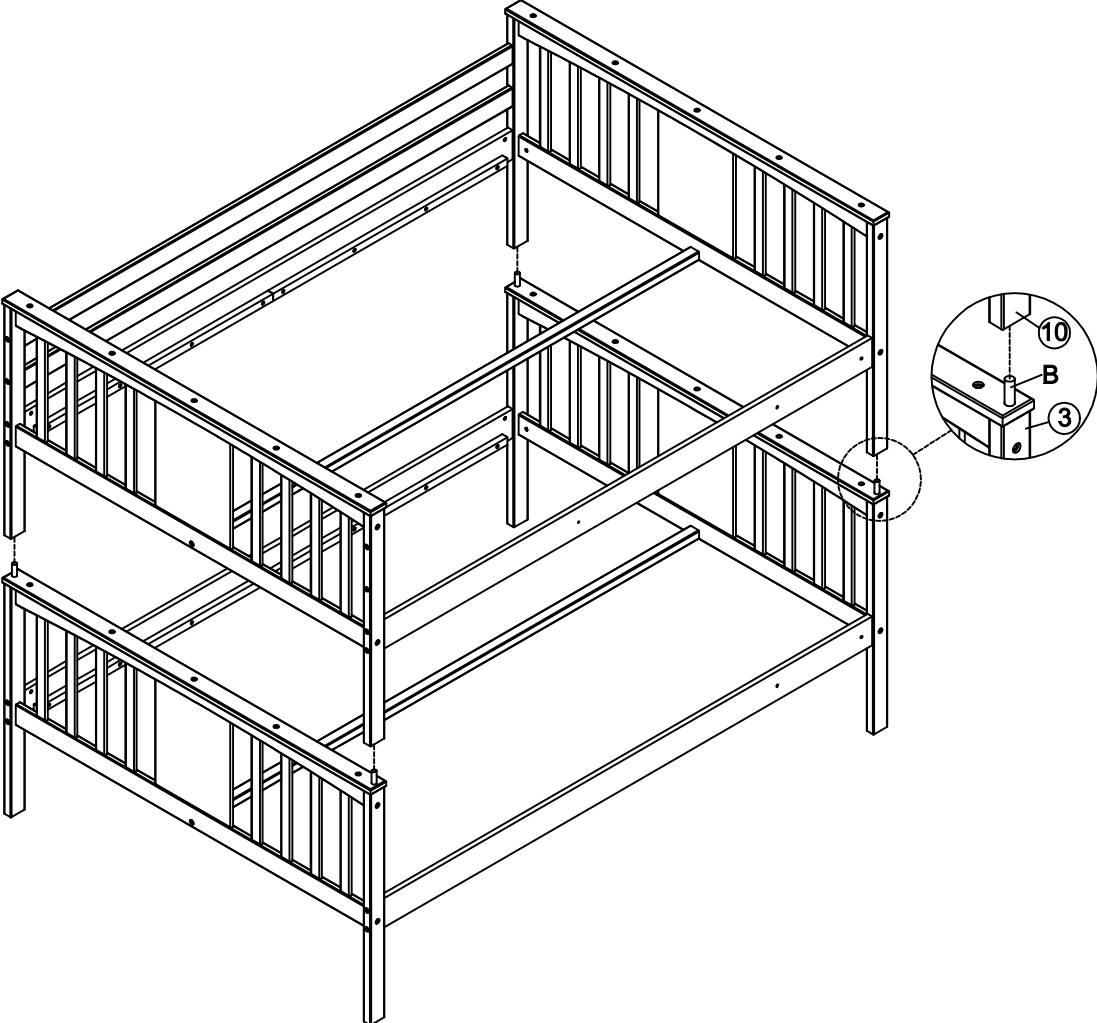

# Step: 10

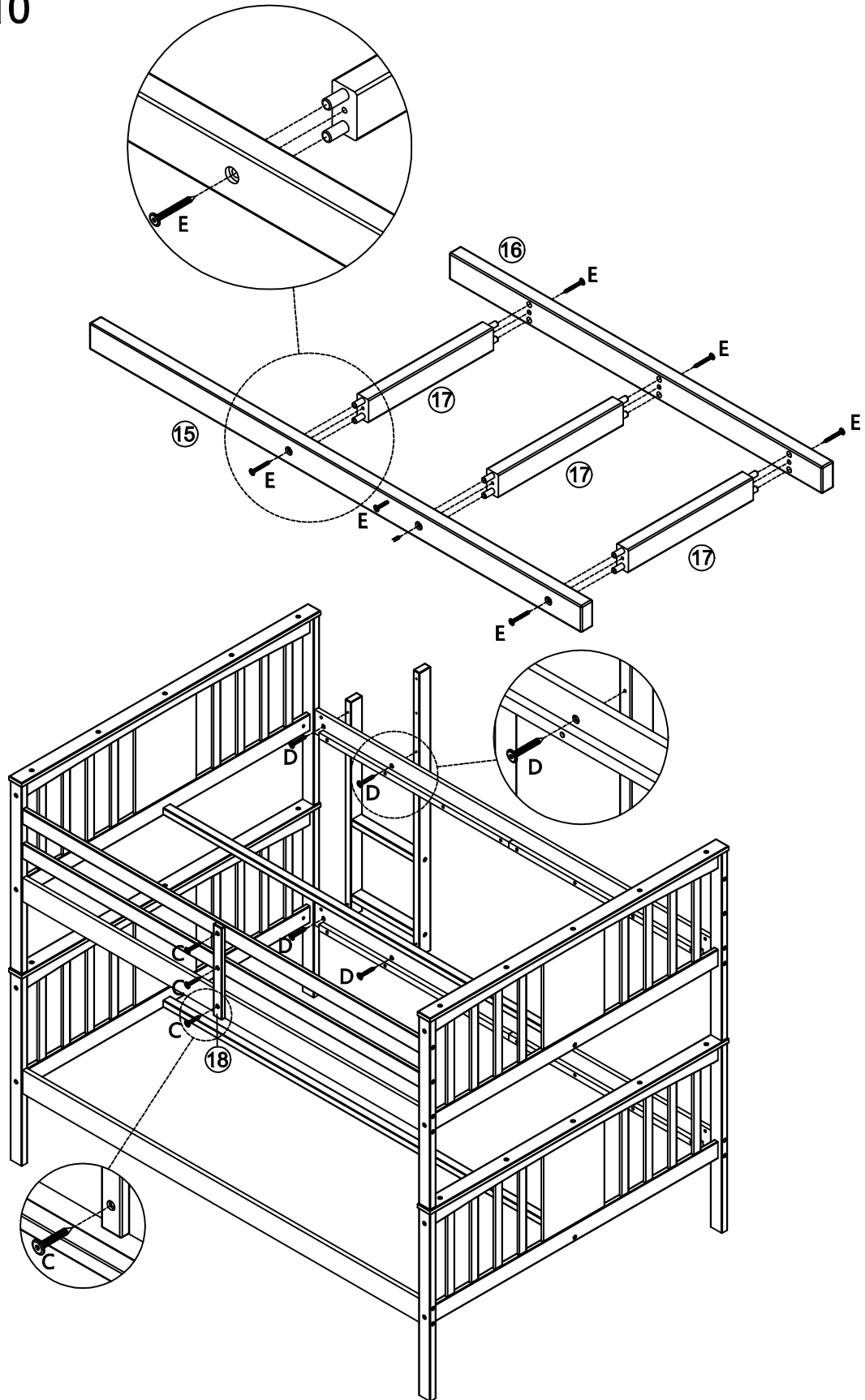

C



Qty  
03

D



Qty  
04

E



Qty  
06

Z



Qty  
01

# Step: 11

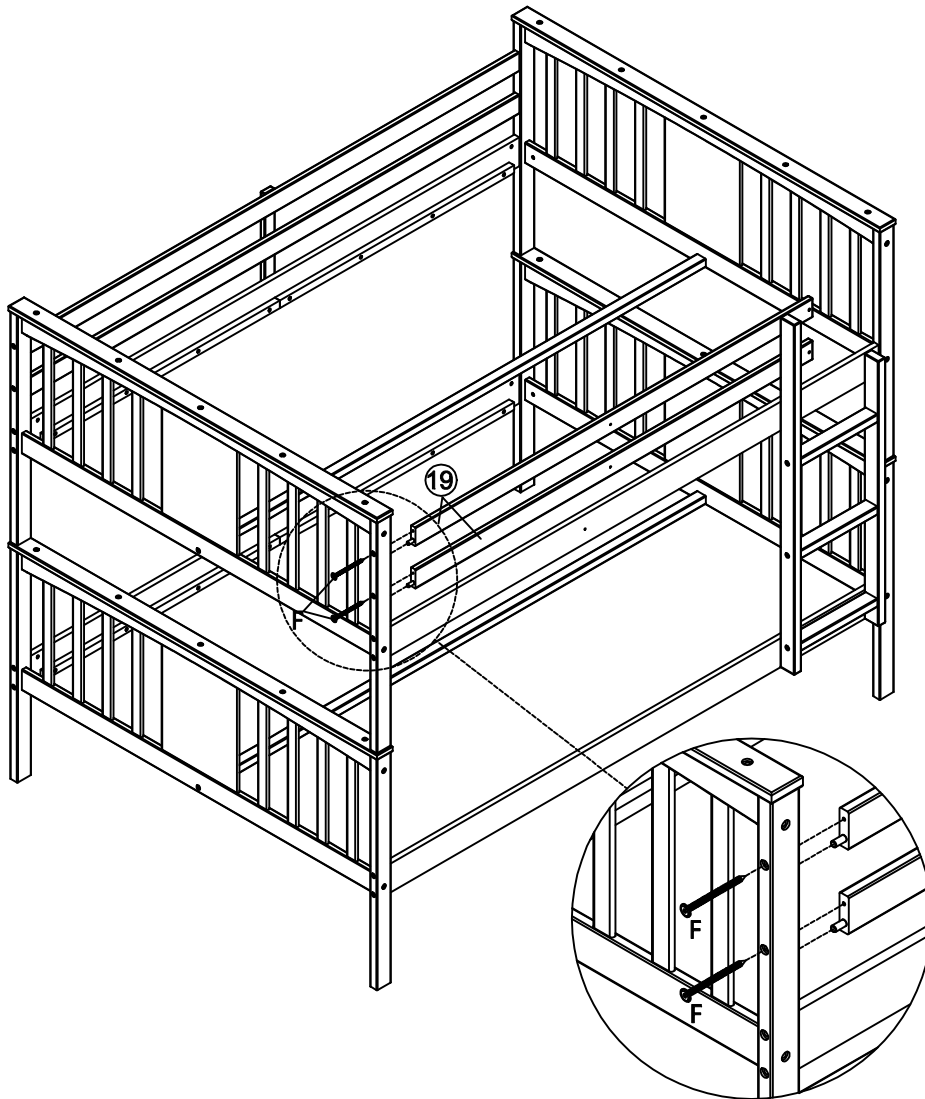



F  Qty 02

Z  Qty 01

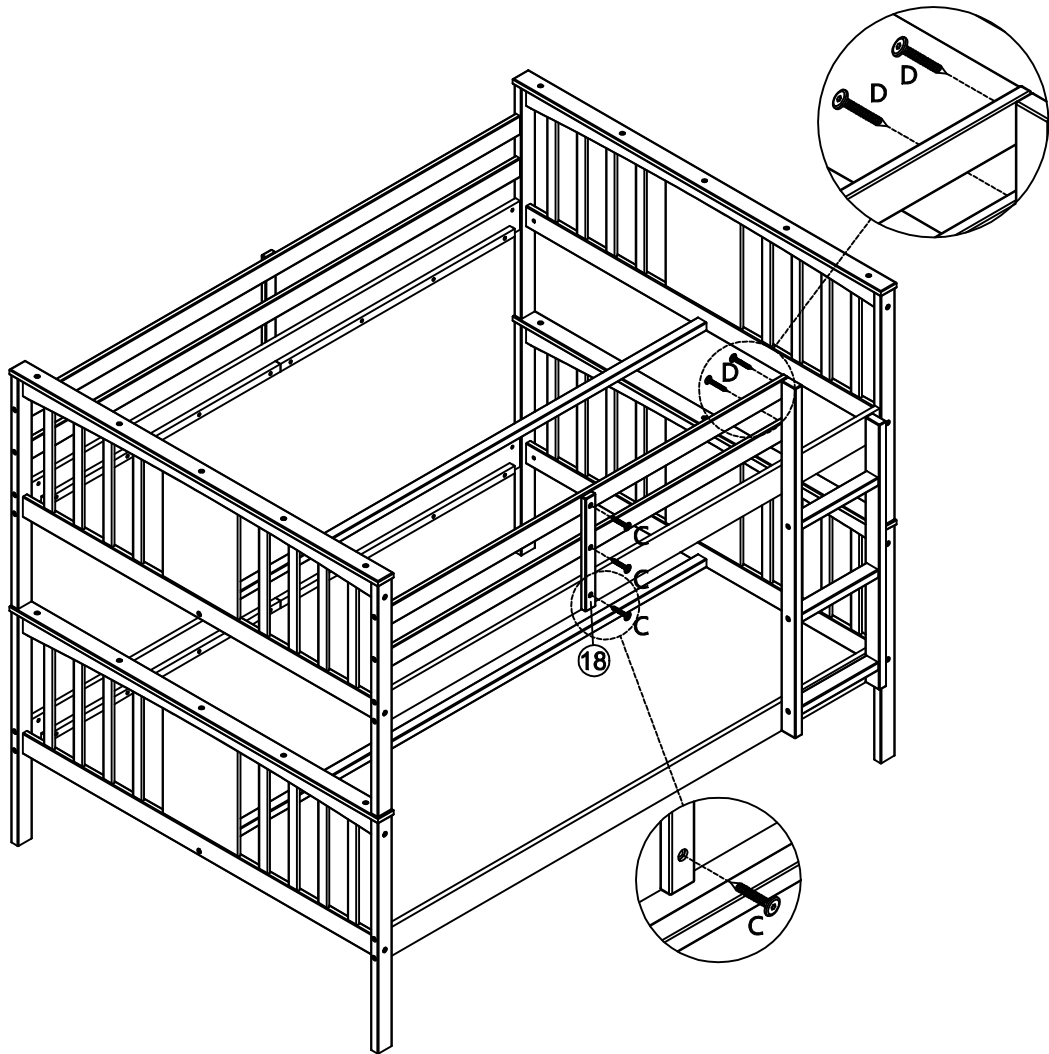
# Step: 12



<b>C</b>		Qty <b>03</b>	<b>D</b>		Qty <b>02</b>	<b>Z</b>		Qty <b>01</b>
----------	---	------------------	----------	--	------------------	----------	---	------------------

# Step: 13

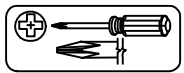
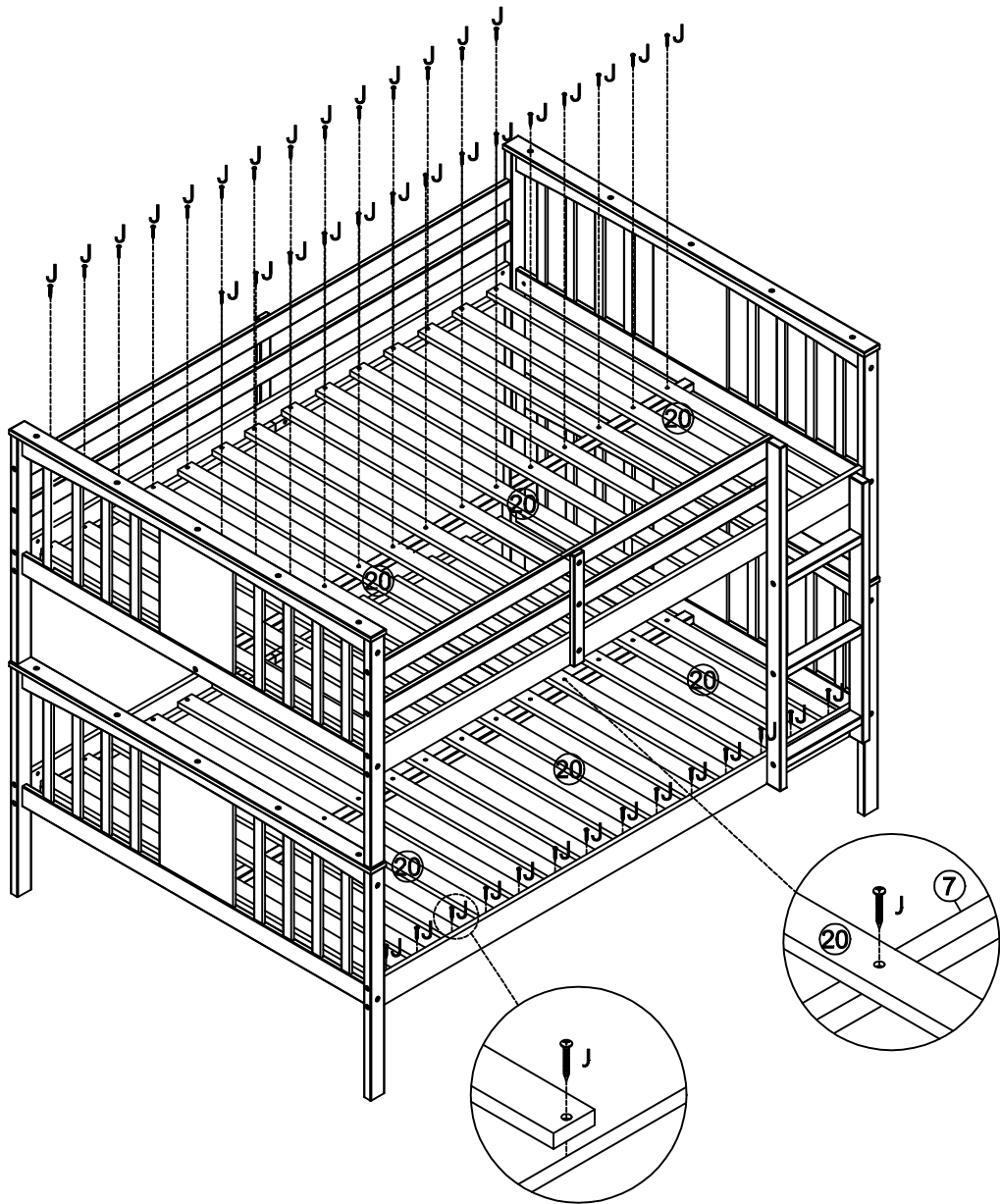

J Qty 84

Step: 14

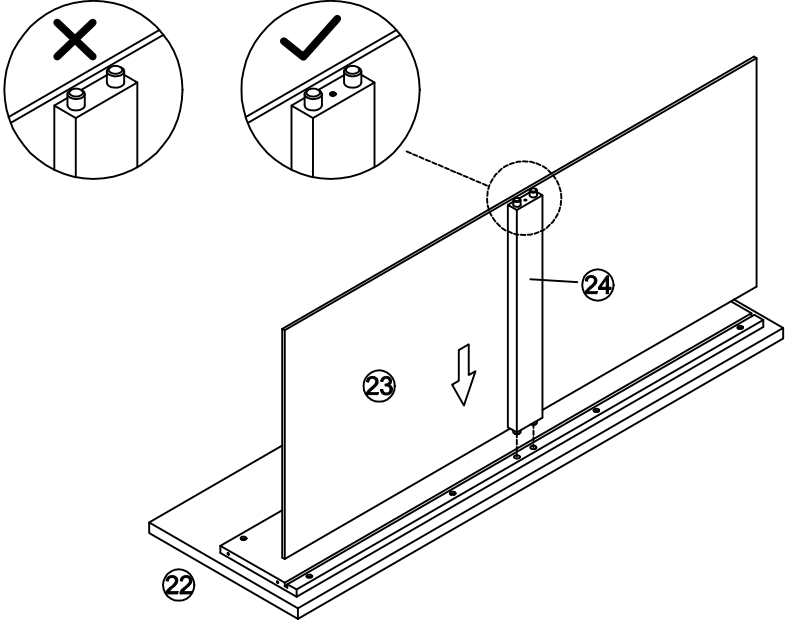

Step: 15

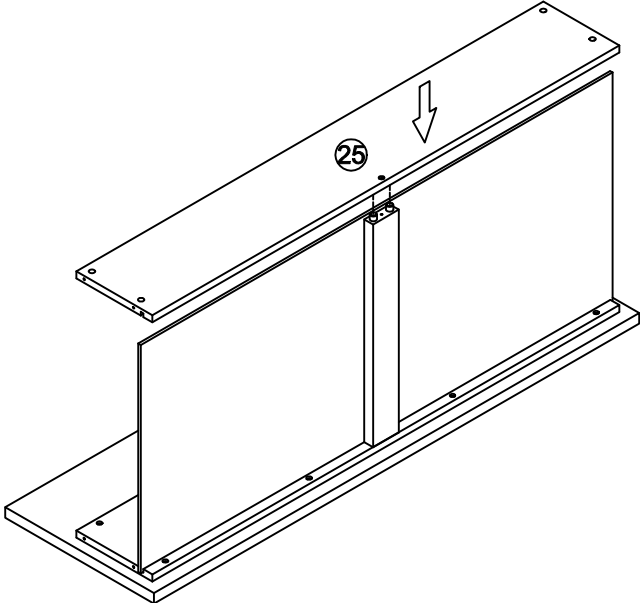

# Step: 16

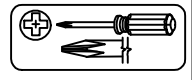
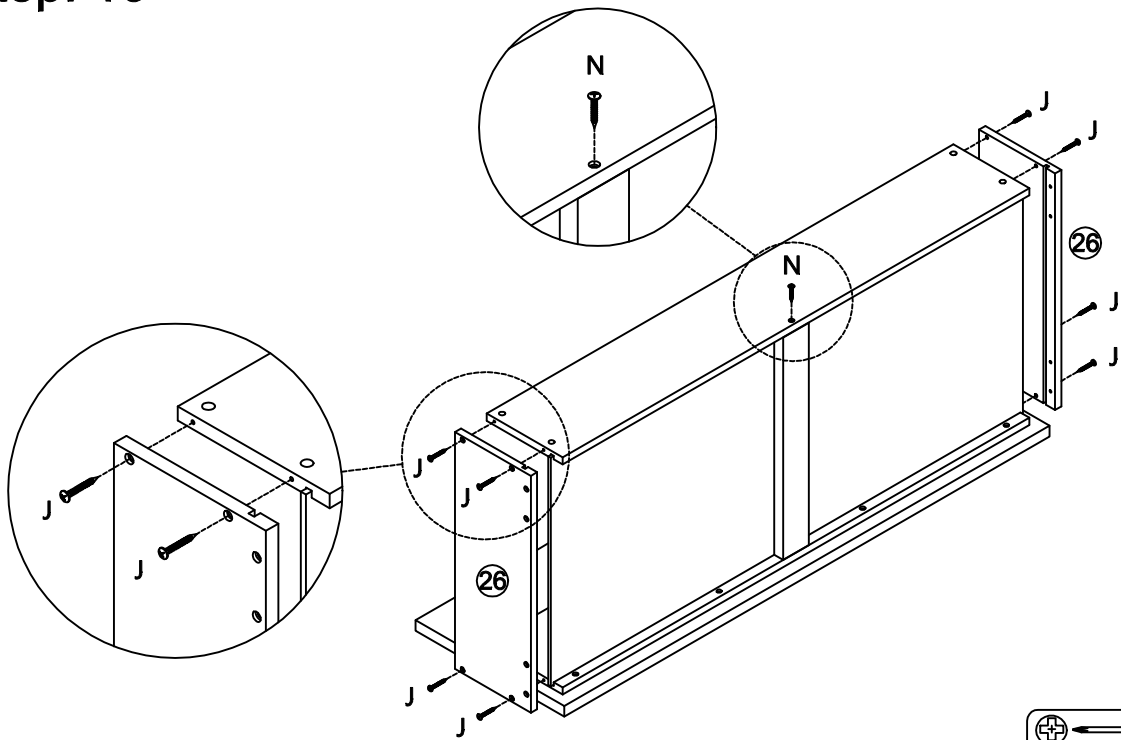

J Qty 16

N Qty 02

# Step: 17

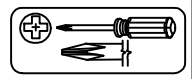
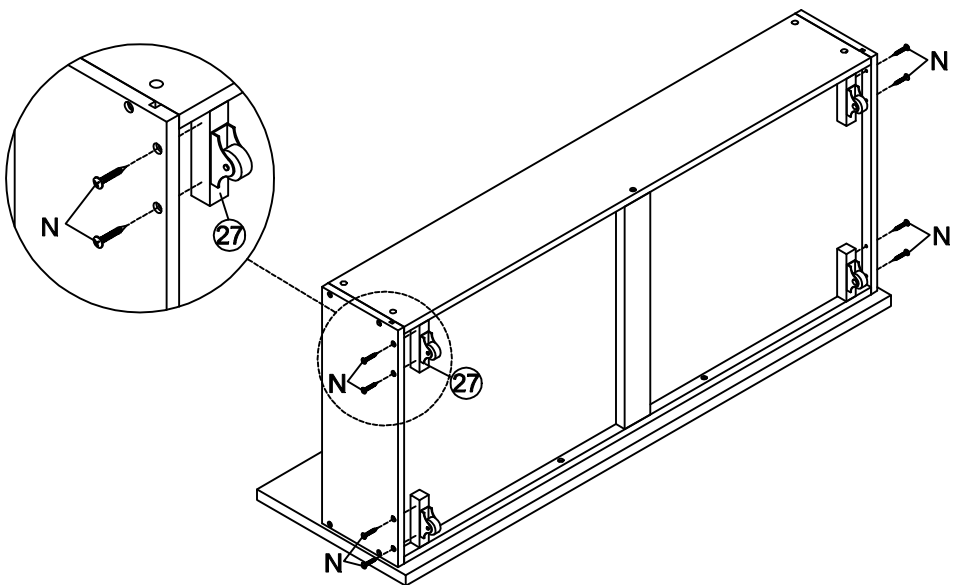

N Qty 16

# Step: 18

