

# Bed Frame 14 Inch

## User Manual

Full/Queen/King

## Precautions





1. Please read the product manual carefully before installation.
2. Place the carton flat on the open ground, open the package, take out the product parts and arrange them according to the numbering sequence.
3. The screw hardware accessory bag shall be carefully torn to prevent splashing.



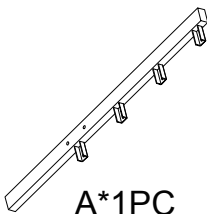
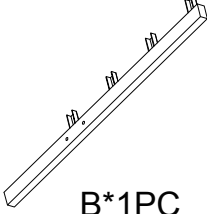
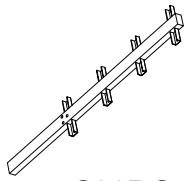
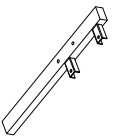
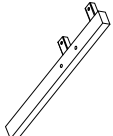
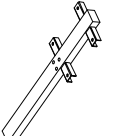
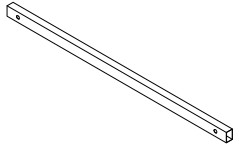

## Product specifications

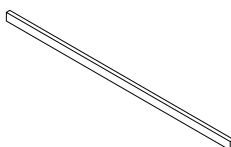
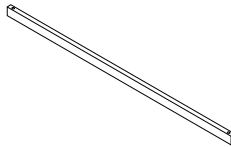
<p><b>Full</b></p> 	<p>Size: Full Color: Black Assembly Required: Yes Box Spring Required: No Overall Product Weight: 57.3 lbs Weight Capacity: 1500 lbs Developed size: 77*56.7*36.8 inch</p>
<p><b>Queen</b></p> 	<p>Size: Queen Color: Black Assembly Required: Yes Box Spring Required: No Overall Product Weight: 61.3 lbs Weight Capacity: 1500 lbs Developed size: 81.9*62.8*36.8 inch</p>
<p><b>King</b></p> 	<p>Size: King Color: Black Assembly Required: Yes Box Spring Required: No Overall Product Weight: 66.7 lbs Weight Capacity: 1500 lbs Developed size: 81.9*78.7*36.8 inch</p>

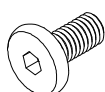
1

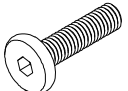
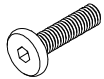
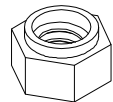
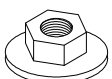
# Product Part Number

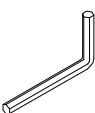
 A*1PC	 B*1PC	 C*1PC	 D*1PC
 E*1PC	 F*1PC	 G*12PCS	 H*2PCS
 I*16PCS	 J*6PCS	 K*1PC	 L*24PCS

 M*14PCS	 N*12PCS	 O*12PCS	 P*12PCS	 Q*1PC	 R*1PC	 S*1PC
--	--	--	--	---	--	--

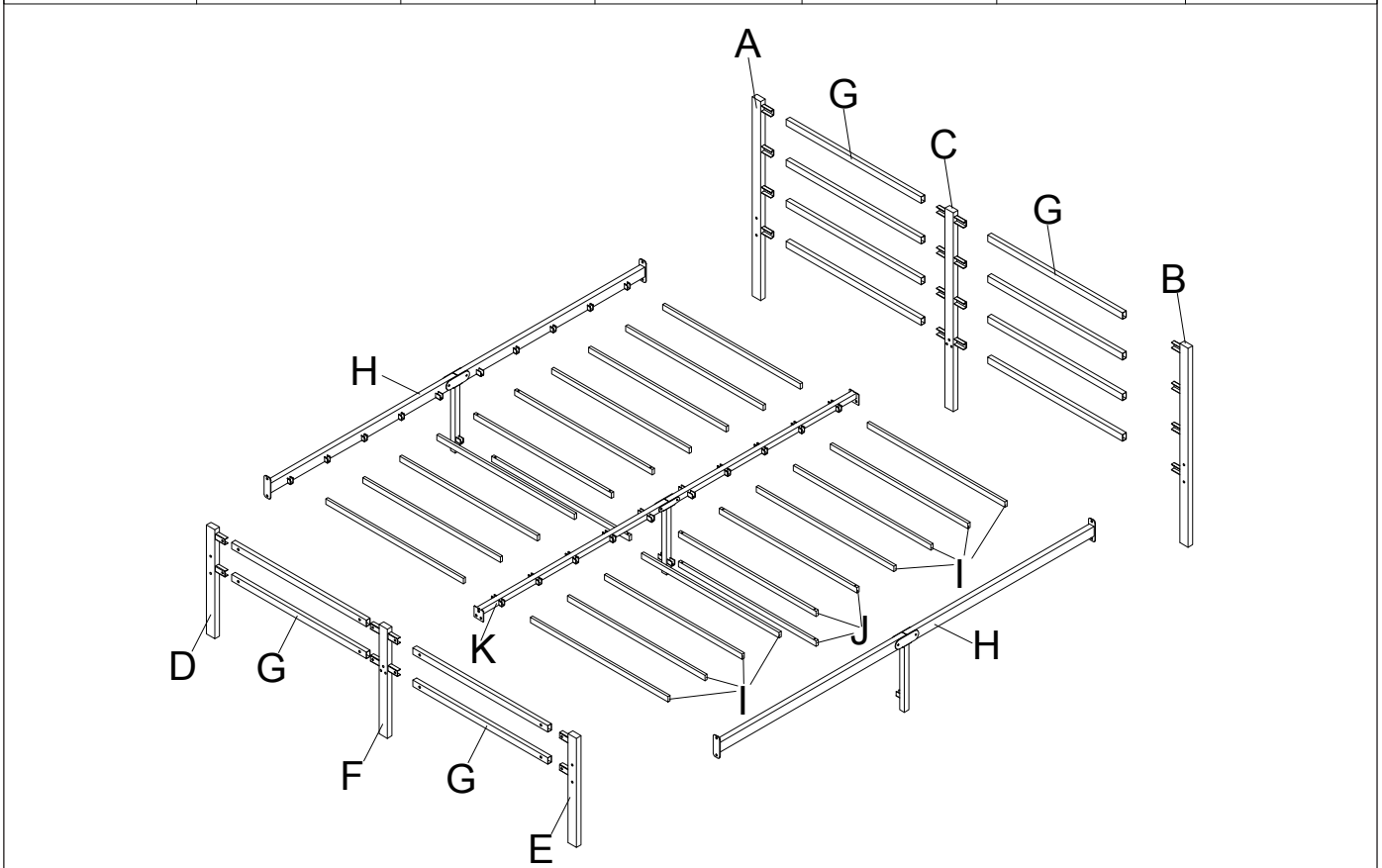

2

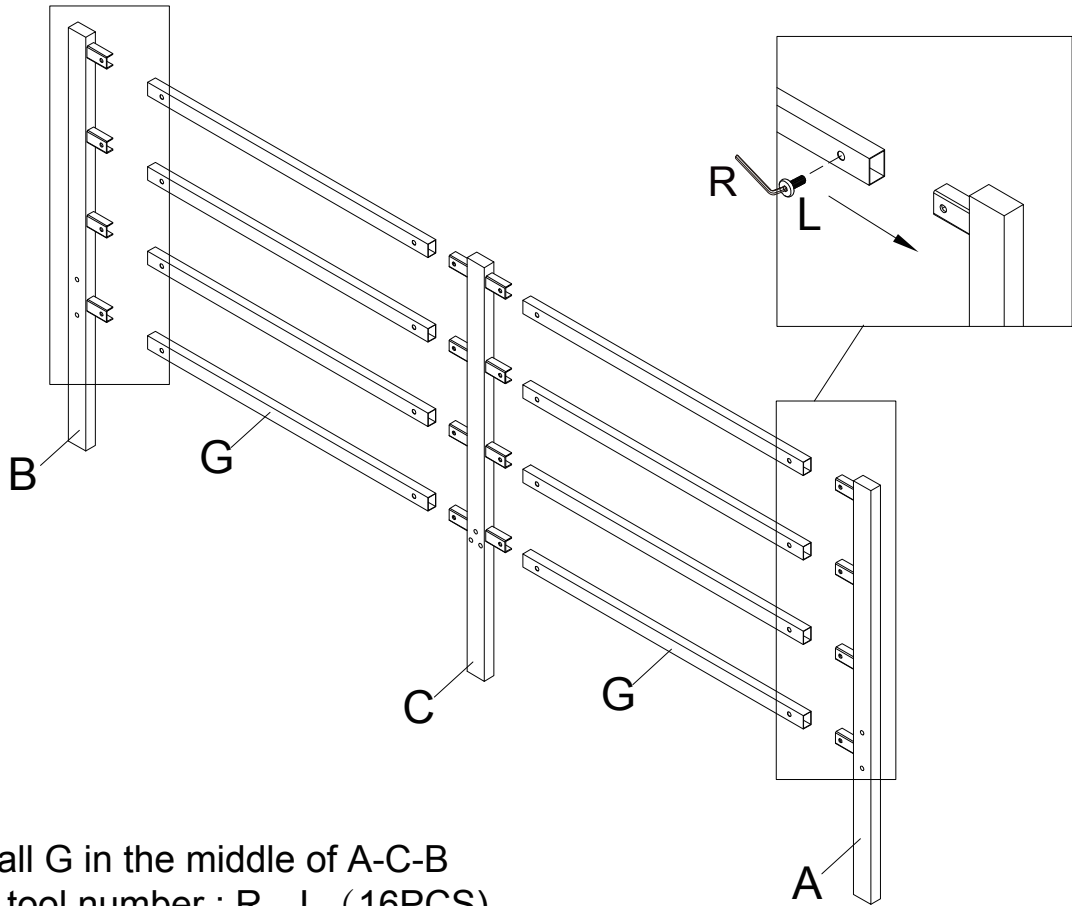

Step 1 :Install G in the middle of A-C-B  
Connection tool number : R、 L (16PCS)

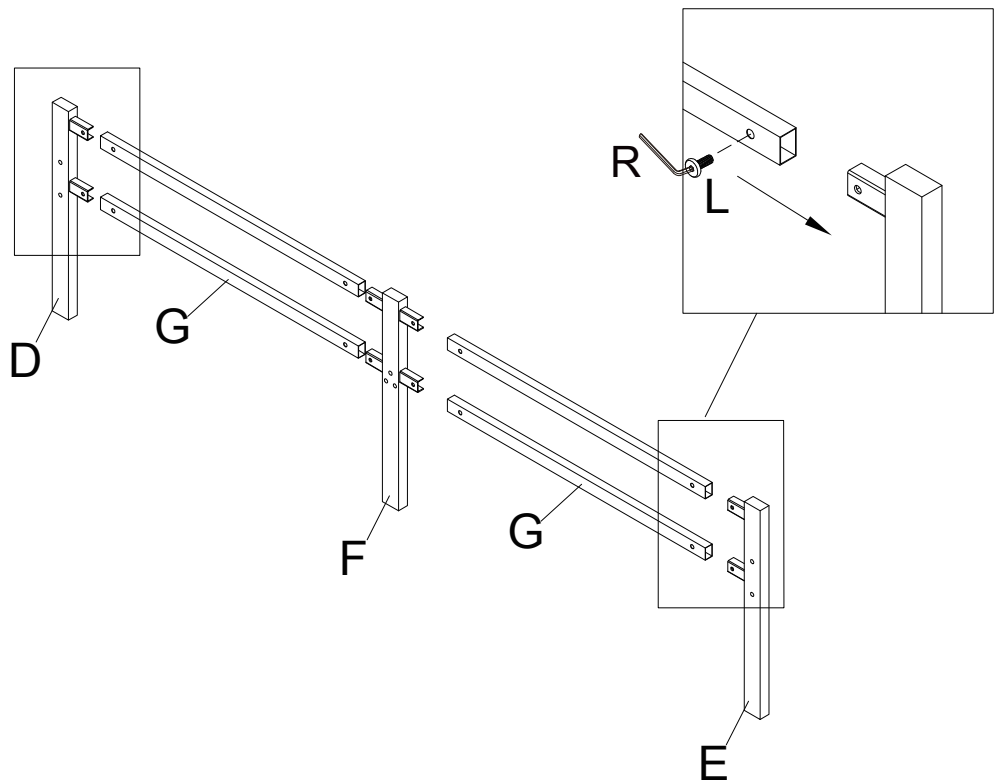

Step 2 :Install G in the middle of D-F-E  
Connection tool number : R、 L (8PCS)

3

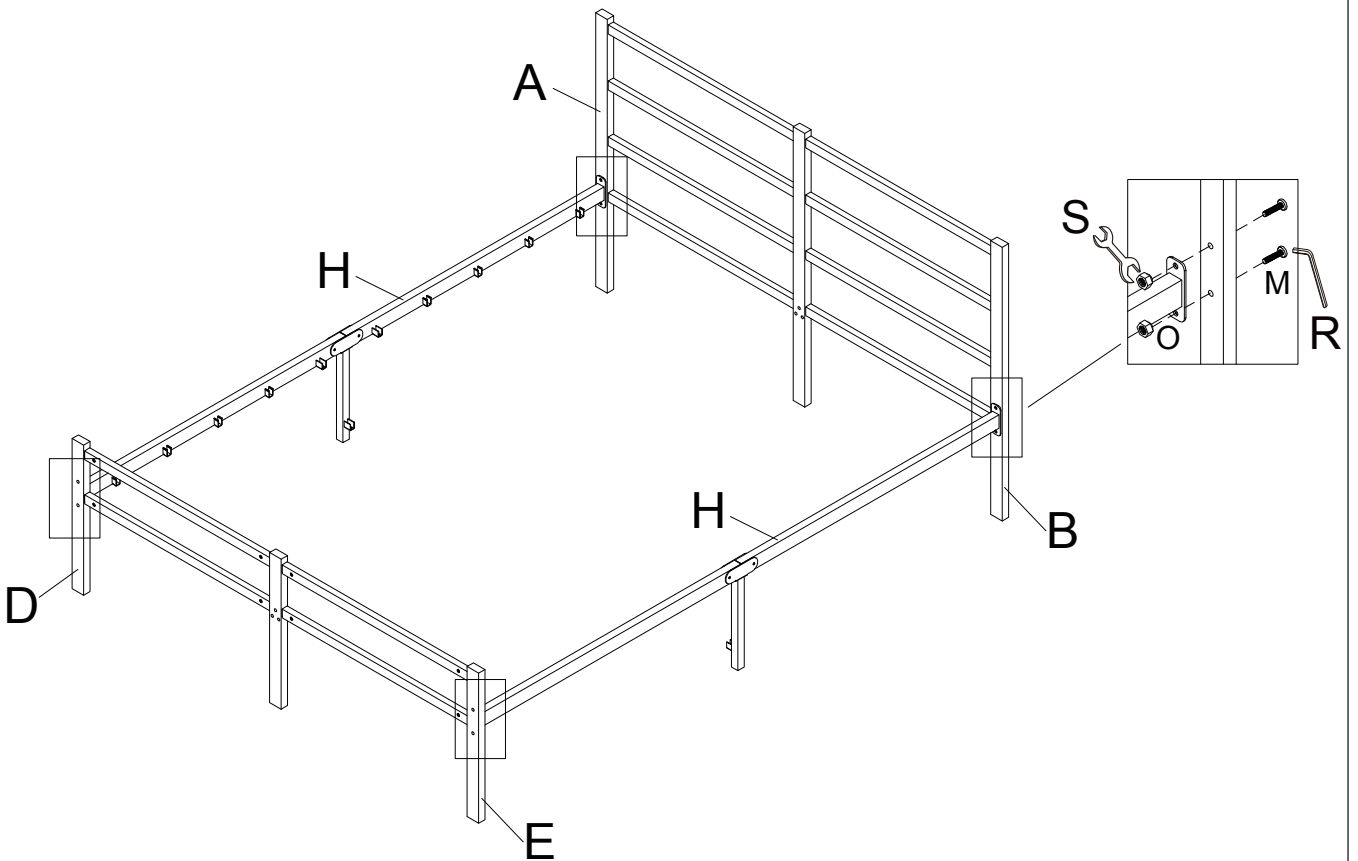
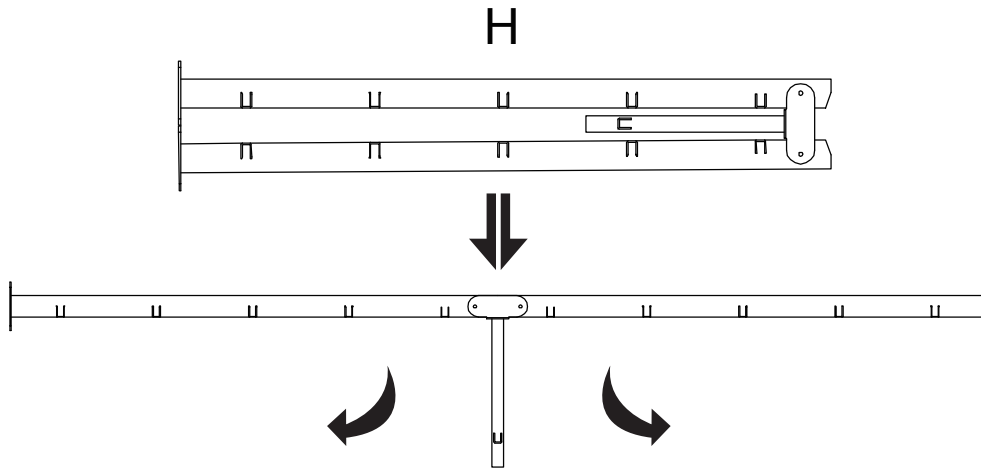

Step 3: Expand H , connect H into the ( A- B ) and ( D -E ) combination  
Connection tool number: R , M (8PCS) ; S , O (8PCS)

4

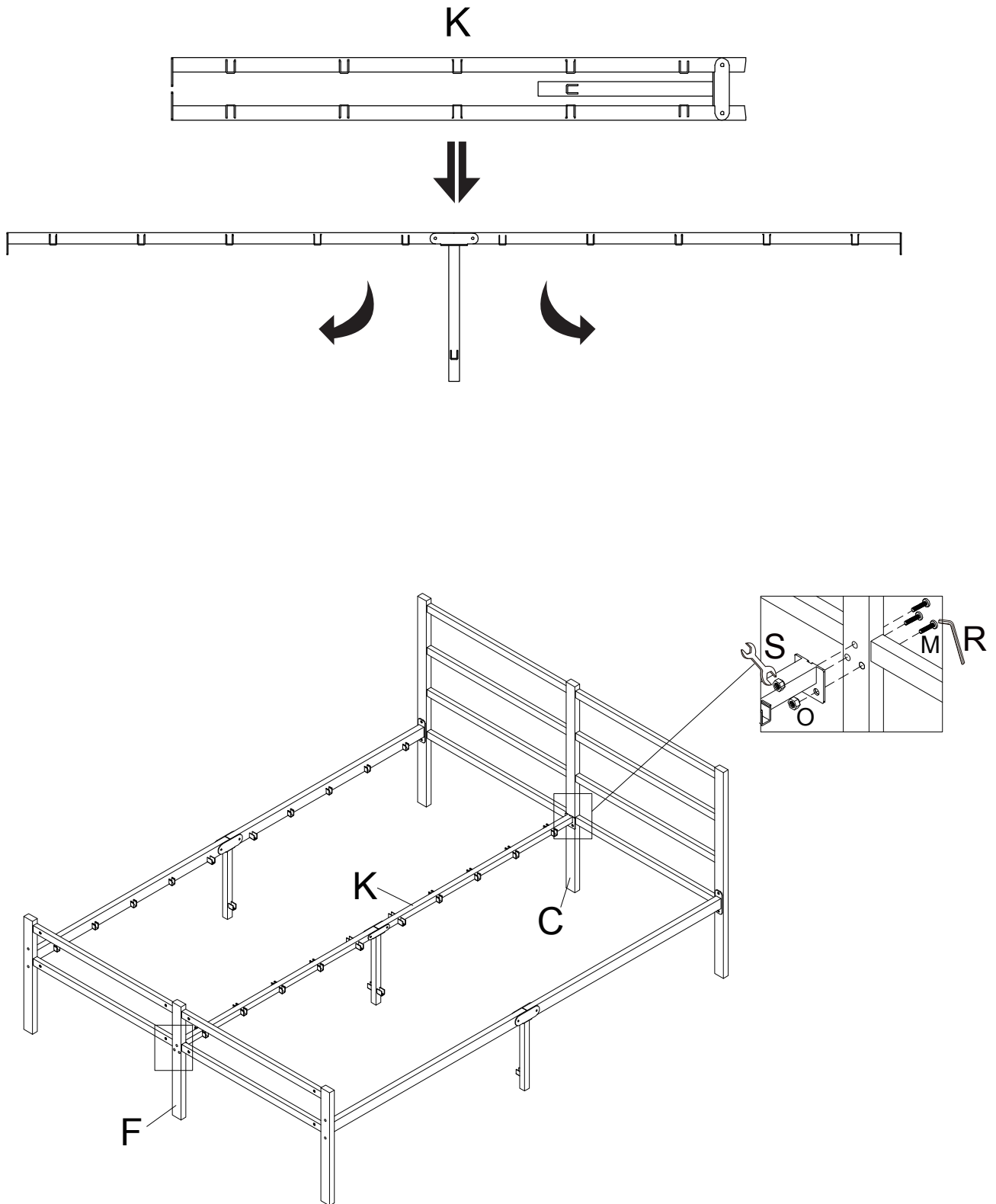

Step 4: Expand K , connect K into the ( C ) and ( F ) combination  
Connection tool number: R , M ( 6PCS ) ; S , O(4PCS)

5

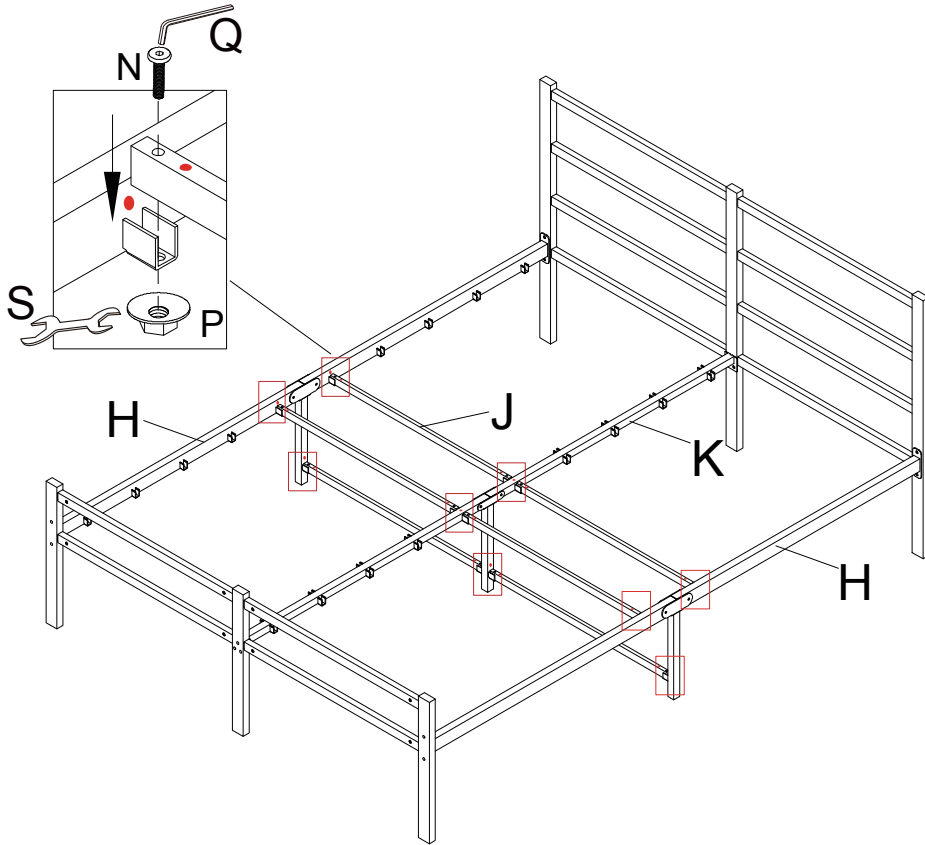

Step 5: Number J(6PCS) Mounts on H-K-H Beam Sides  
Connection tool number: Q , N (12PCS) ; S , P (12PCS)

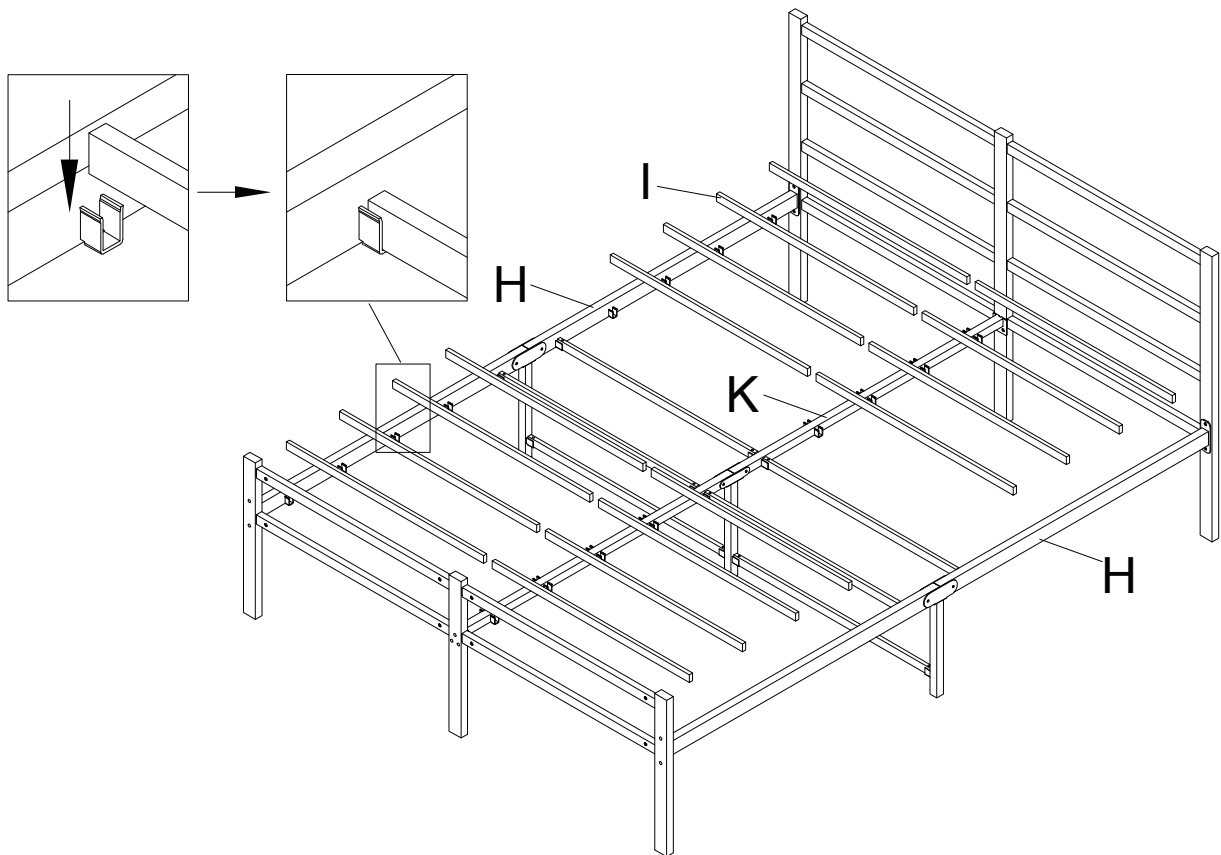

Step 6: Number I(16PCS) Mounts on H-K-H Beam Sides.



**Thank you for your purchase!**  
**We would love to hear your feedback!**

To ensure we continue providing the best customer experience possible, please consider writing a customer review to share your experience.