

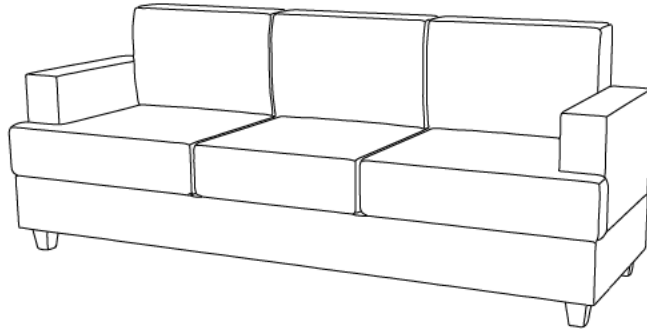

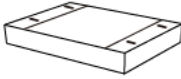





# ASSEMBLY INSTRUCTION

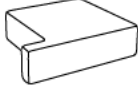

## PARTS LIST

						
<b>A</b> x1	<b>B</b> x3	<b>C</b> x3	<b>L</b> x1	<b>R</b> x1	<b>D</b> x1	<b>E</b> x2

## HARDWARE LIST

						
<b>1</b> x4	<b>2</b> x4					

Please open the black woven fabric with Velcro closure on the bottom of the frame then cut off the black straps before removing the parts for assembly.

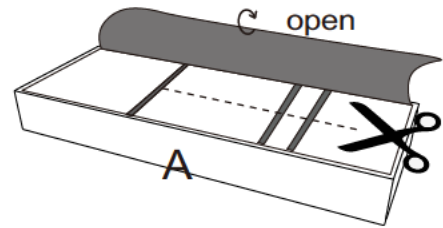

Please allow at least 24 hours for the cushions to recover to its natural state after removing from the package.

### Step 1

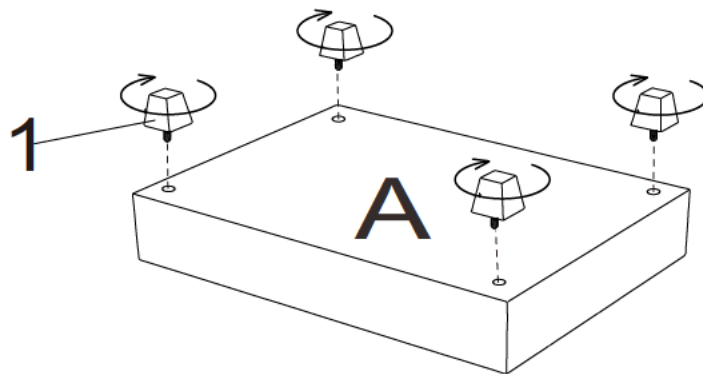

### Step 2

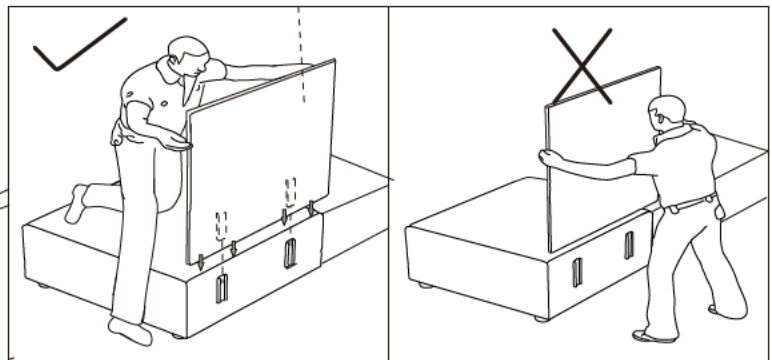
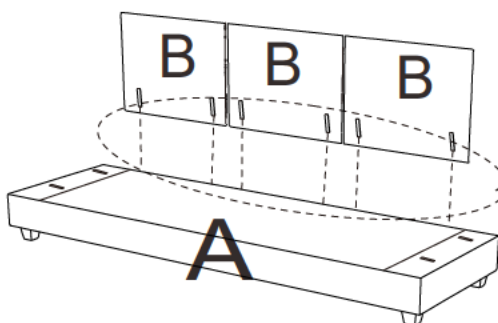

# ASSEMBLY INSTRUCTION

## Step3

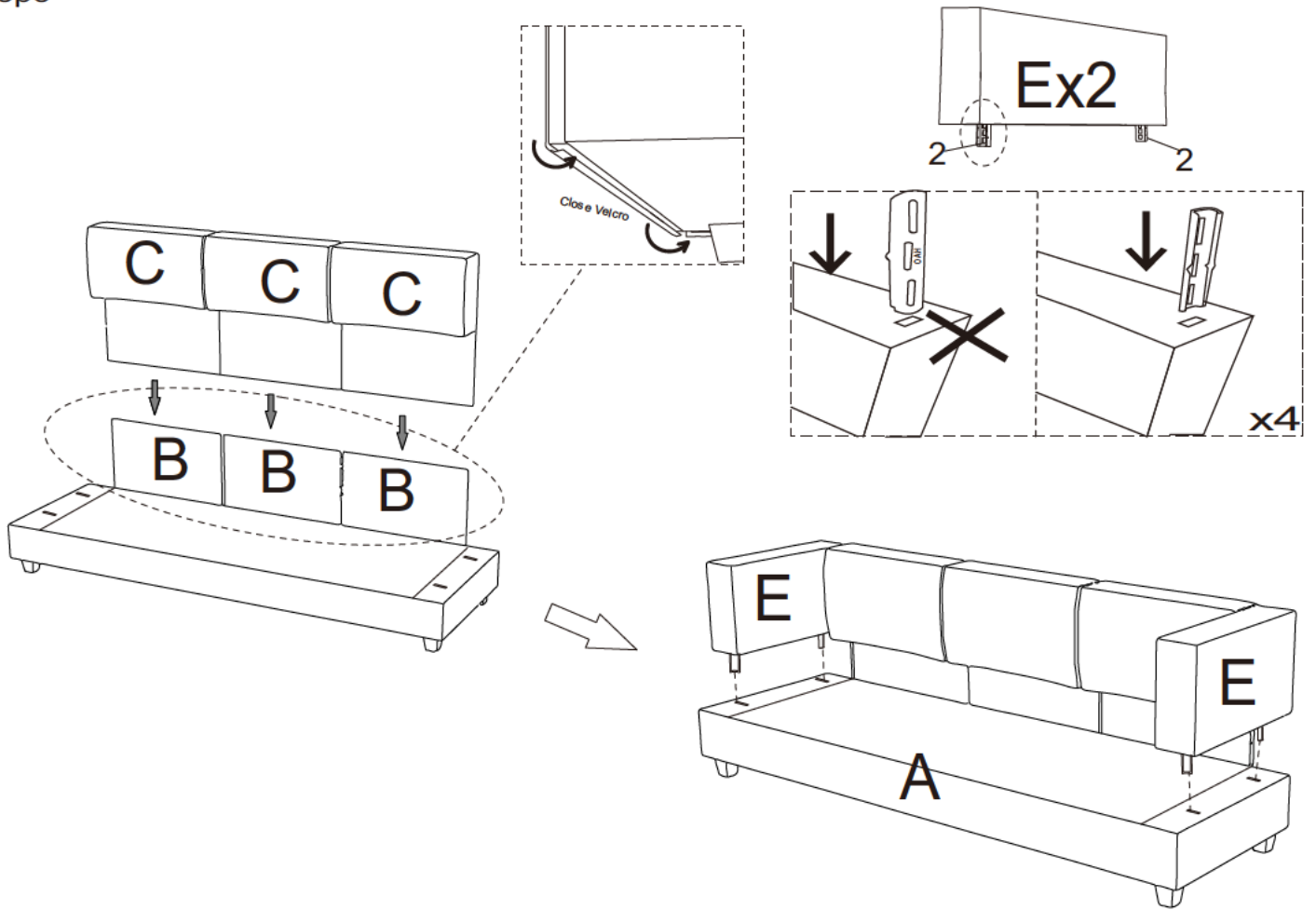

## Step4

