

Top View

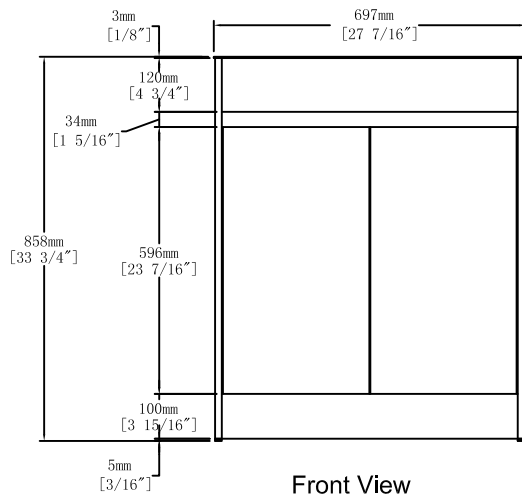

Front View

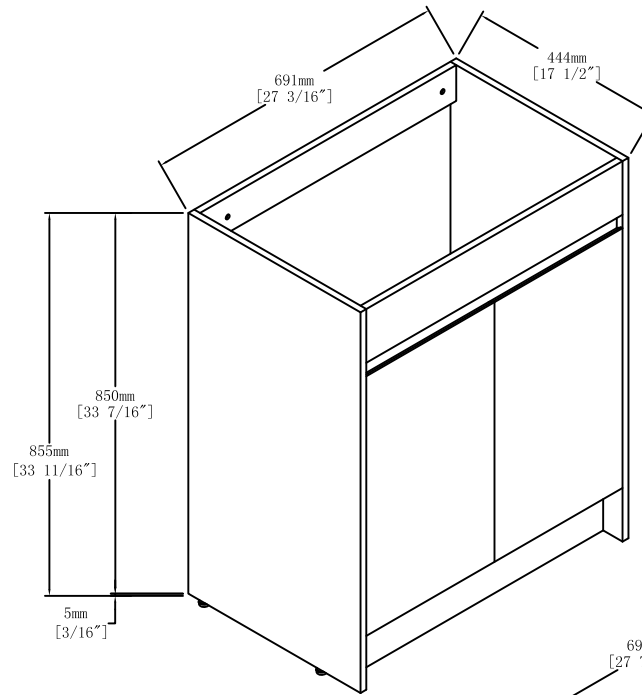
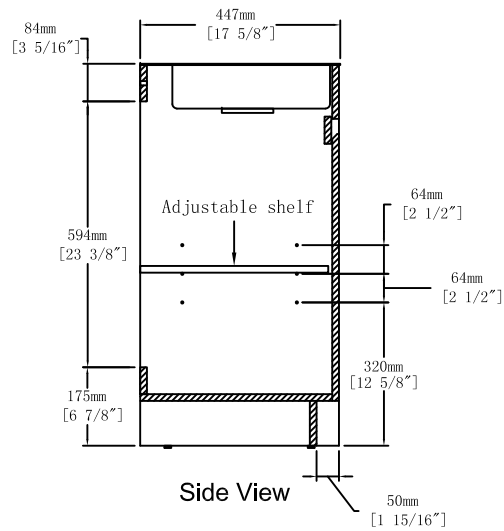

Side View

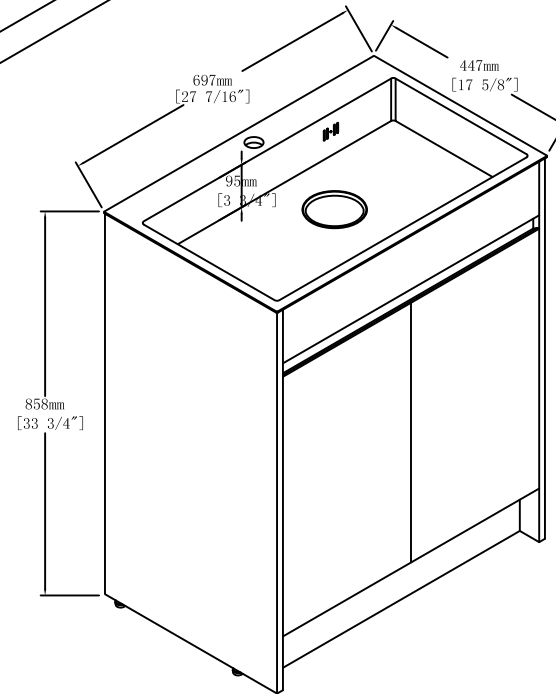

Item NO.

BV B13128

Version

V1

Project

Date

2025-10-28