

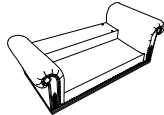









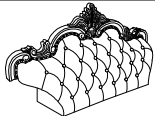

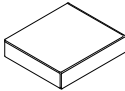
ASSEMBLY INSTRUCTION

LOVE SEAT

NOTE: Do not use power tools for assembly. Power tools increase the risk of over tightening which leads to splitting or cracking the wood.

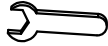
COMPONENT LIST (LEG, PILLOW AND HARDWARE ARE PACKED IN 9815-2A)

NO	DESCRIPTION	DRAWING	QTY	NO	DESCRIPTION	DRAWING	QTY
A	LOVE SEAT BASE		1PC	H	LOCK WASHER		12PCS
B	LOVE SEAT BACK		1PC	I	FLAT WASHER		12PCS
C	SEAT CUSHION		2PCS	J	ALLEN KEY		1PC
D	PILLOW		2PCS	K	FULL THREAD BOLT		4PCS
E	LEG		4PCS	L	NUT		4PCS
F	DOWEL		4PCS	M	WRENCH		1PC
G	BOLT		8PCS				

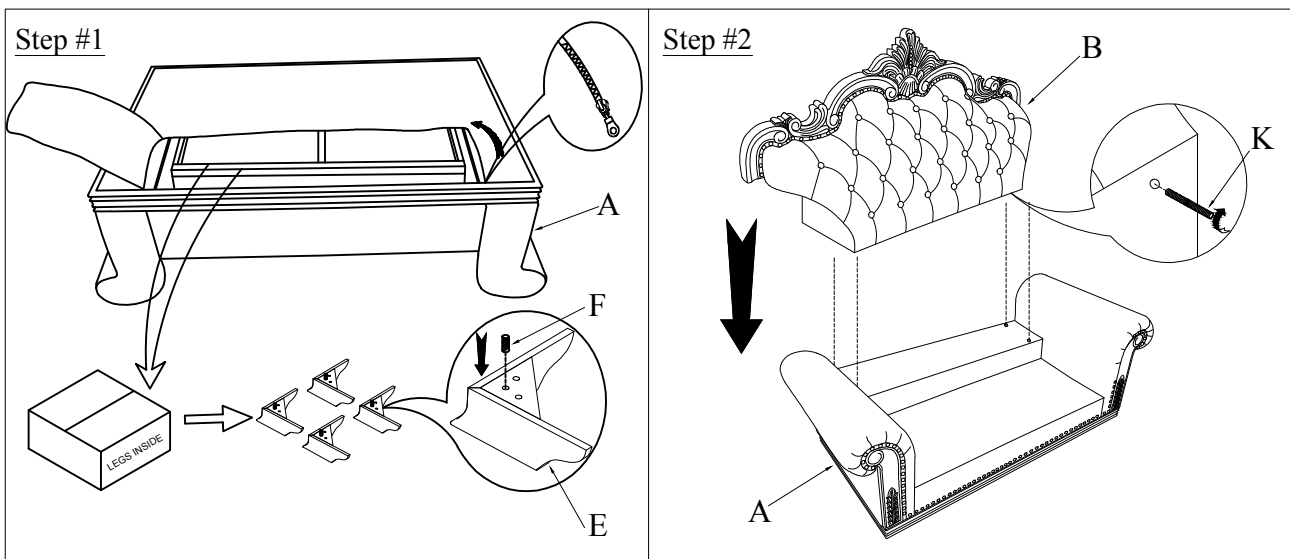

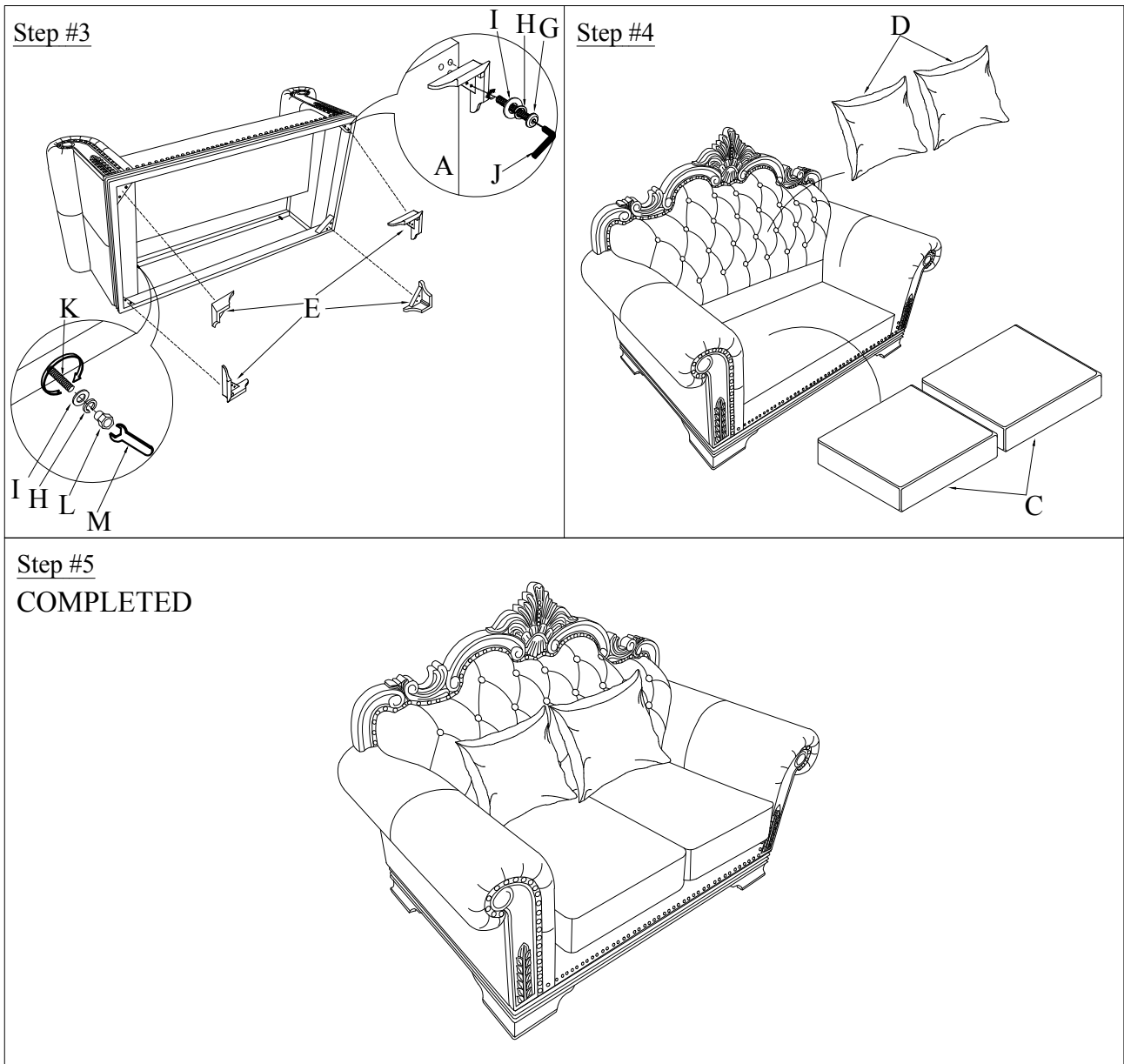

CARE INSTRUCTION FOR POLYESTER:

In order to maintain the original appearance of your polyester furniture, please follow below simple care procedure:

- Avoid exposing furniture directly to sunlight or heating and air conditioning outlets. Exposure to sunlight or heating and air conditioning outlets will fade/ damage polyester.
- Wipe gently with a damp soft cloth to remove dust, dirt and any grime build up.



It is recommended to install protective pads under all legs and supports to avoid damage or scratches when placing furniture on a wood floor or other hard surface, and to limit indentation and prevent discoloration if placing on carpet.



Il est recommandé de placer des coussins protecteurs sous tous les pieds et toutes les bases des meubles pour éviter d'endommager ou d'égratigner les planchers en bois ou autres surfaces dures, et pour limiter l'empreinte et empêcher la décoloration quand les meubles reposent sur la moquette.