

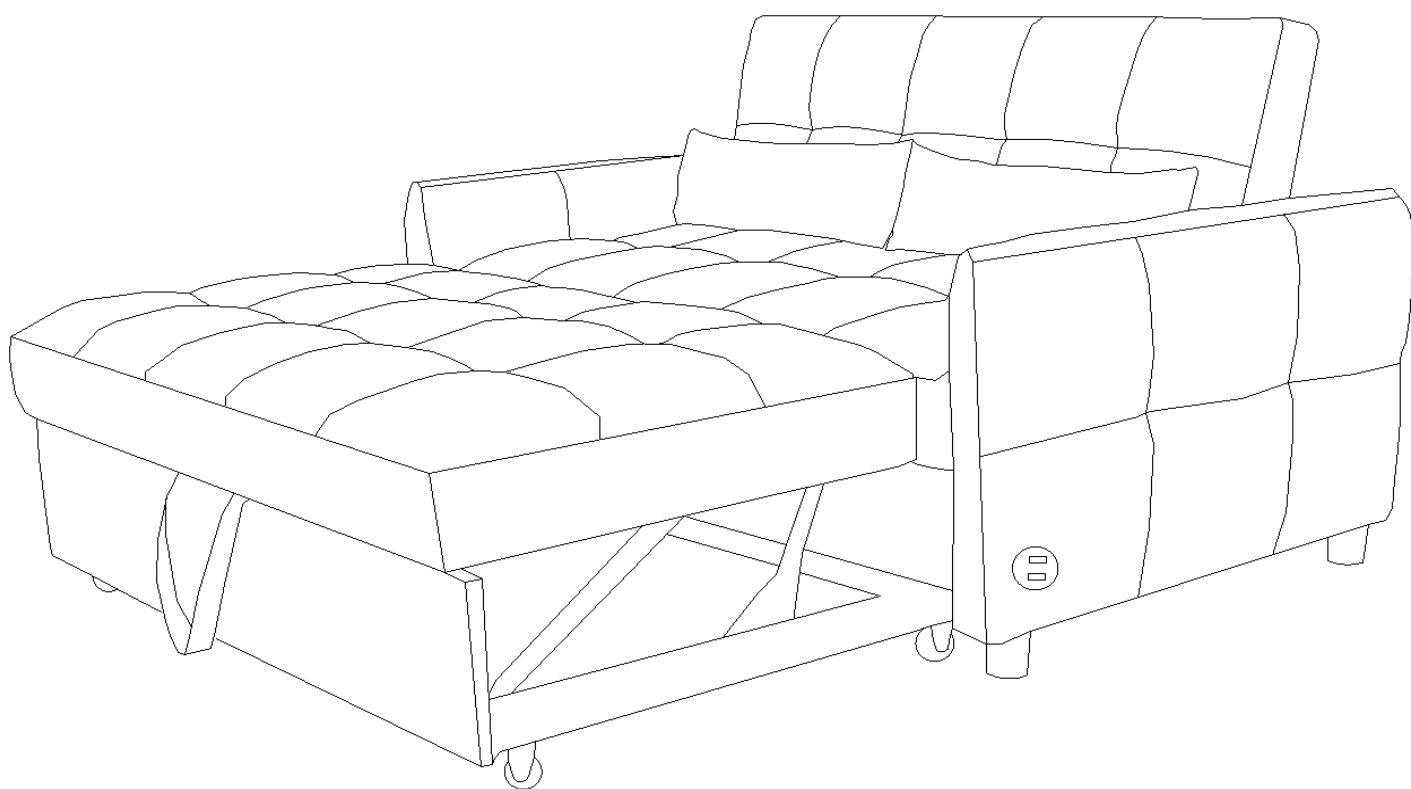

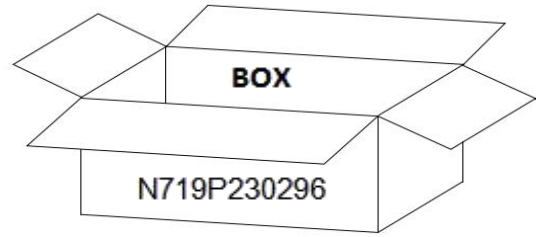

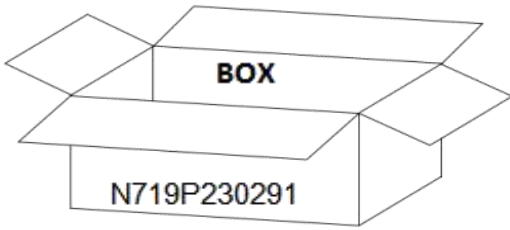

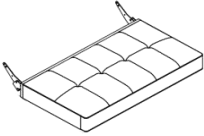
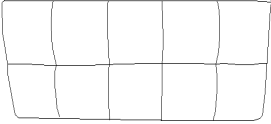

Assembly Instruction



PARTS LIST

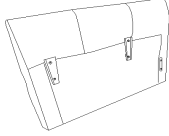
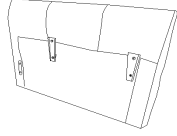

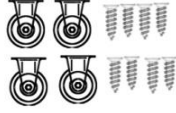
A		Seat Cushion	1 PC
B		Back Cushion	1 PC
C		Back Board	1 PC
D		Pillow	2 PCS

E		Trundle Bed	1 PC
F		Left Armrest	1 PC
G		Right Armrest	1 PC
H		Plastic Leg	4 PCS
I		Guide-Rail Wheel	4PCS
J		Usb Power	1 PC
K		Allen Key	1 PC

Step 1:

Connect the armrests to the seat cushion latch after the 4 plastic legs are installed under the armrests.

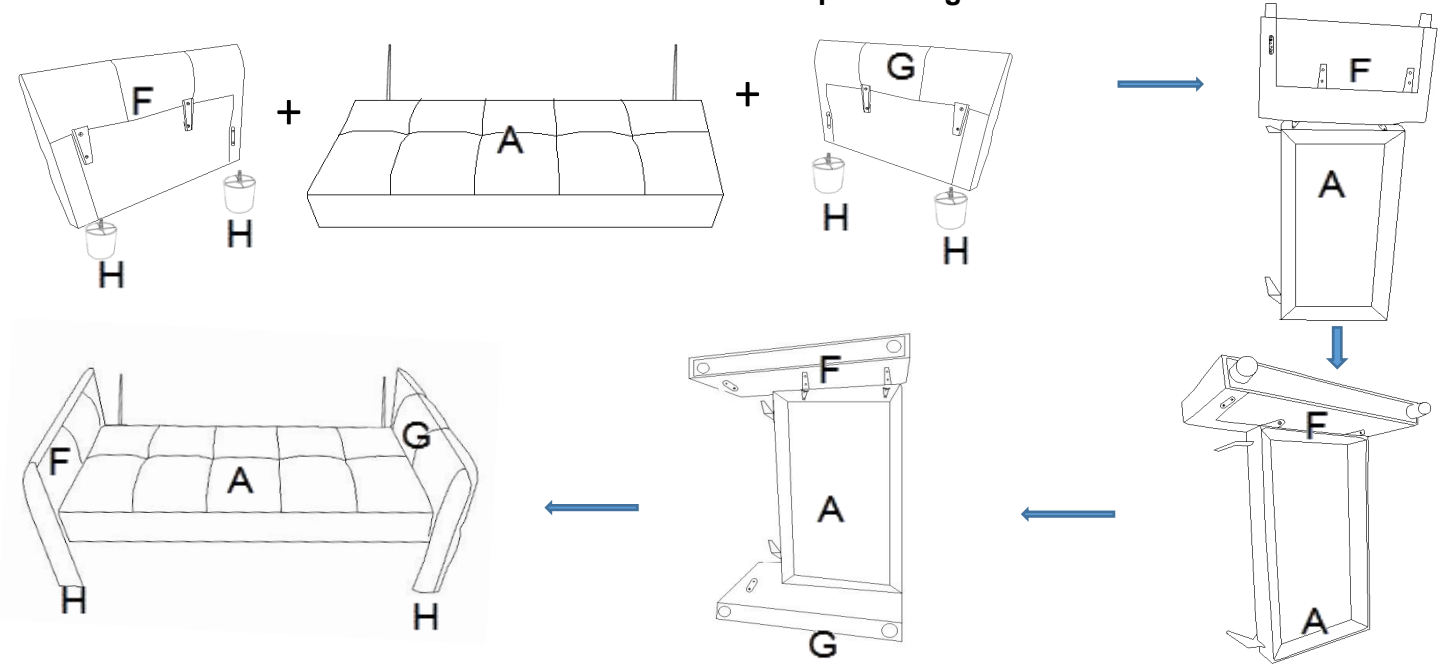

Step 2: Attach the seat cushion to the back cushion.

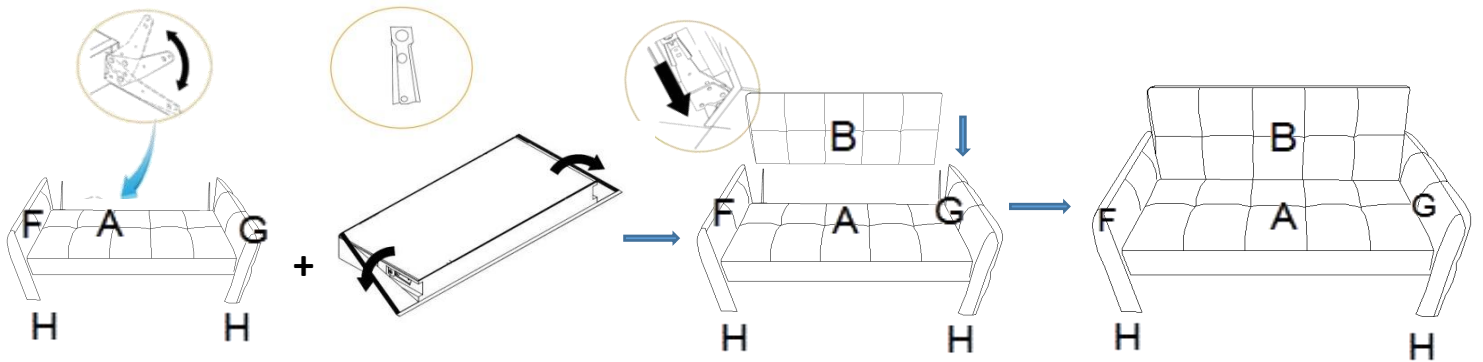

Step 3: Use a wrench to fix the back board to the rear nut of the armrests.

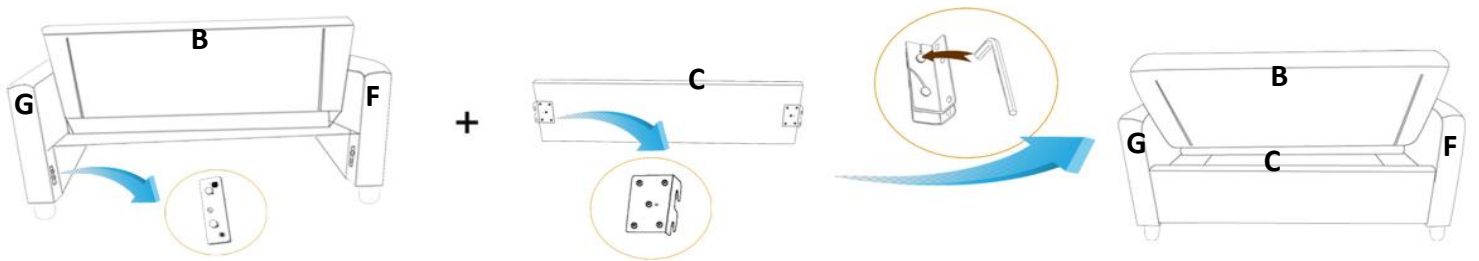

Step 4: Install 4 wheels on bottom of trundle bed, please use tools to set screws .

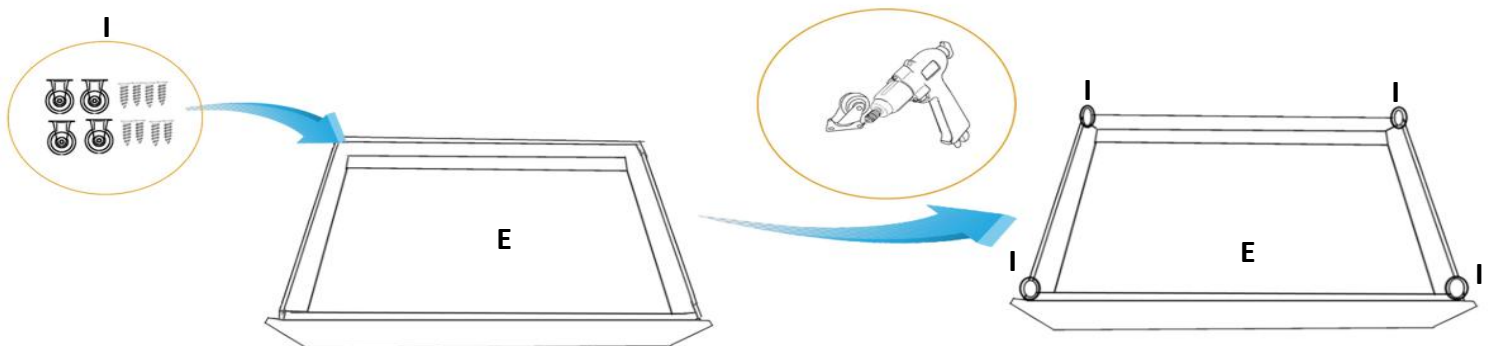

Step 5: Place the trundle bed under the seat cushion, please meticulously avoid the positioning components in the armrests.

