

# 4 TIER BOOKSHELF

Instruction manual

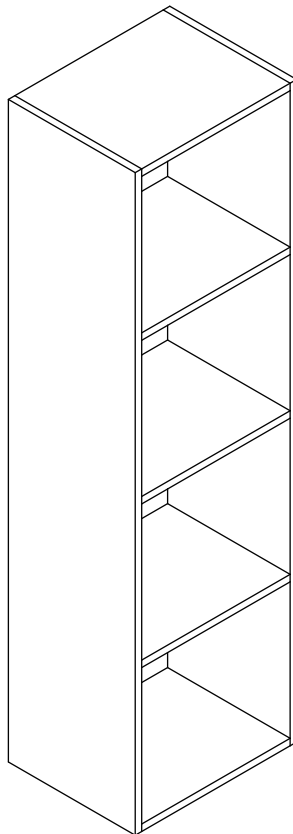

# CONTENTS

---

Safety and care advice	<b>1</b>
Components – panels	<b>2</b>
Components – fittings	<b>3</b>
Assembly instructions	<b>4</b>
Copyright	<b>8</b>

---

# ⚠️ SAFETY AND CARE ADVICE ⚠️

---

PLEASE READ THESE INSTRUCTIONS CAREFULLY AND KEEP FOR FUTURE REFERENCE

**Warning:** Please lift with care.

- Check you have all the components and tools listed on pages 2 and 3.
- Remove all fittings from the plastic bags and separate them into their groups.
- Keep children and animals away from the work area, small parts could choke if swallowed.
- Make sure you have enough space to layout the parts before starting.
- Do not stand or put weight on the product, this could cause damage.
- Assemble the item as close to its final position (in the same room) as possible.
- Assemble on a soft level surface to avoid damaging the unit or your floor (use opened out unit carton).



- We do not recommend the use of power drill/drivers **for inserting screws**, as this could damage the unit. Only use hand screwdrivers.
- Safety note:** If there is any chance of this unit being pulled over by children etc. it is recommended that the unit is secured to a wall using suitable fixings (not supplied).
- Dispose of all packaging carefully and responsibly.

## CARE AND MAINTENANCE

---

- Only clean using a damp cloth and mild detergent, do no use bleach or abrasive cleaners.
  - From time to time check that there are no loose screws on this unit.
  - This product should not be discarded with household waste. Take to your local authority waste disposal center.
- Note:** *If required the next page can be cut out and used as reference throughout the assembly. Keep this page with these instructions for future reference*

# COMPONENTS — PANELS

Please check you have all the panels listed below:

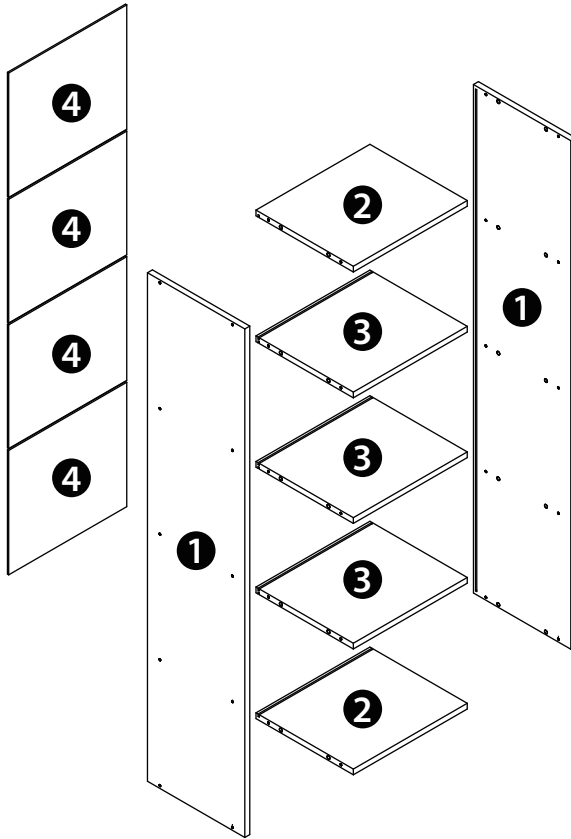

## PANEL LIST

1	Left Side Panel/Right Side Panel	x2	3	Shelf Panel	x3
2	Top Panel/Bottom Panel	x2	4	Back Panel	x4



# COMPONENTS — FITTINGS

---

Please check you have all the fittings listed below:



Screw x 20



Hole cover x 20



Wooden Dowel x 20



Safety Device x 1



Screw x 1



Screw x 2

**TOOLS NEEDED**  
(We don't provide)



Phillips Screwdriver x 1



# ASSEMBLY INSTRUCTIONS

## Step 1

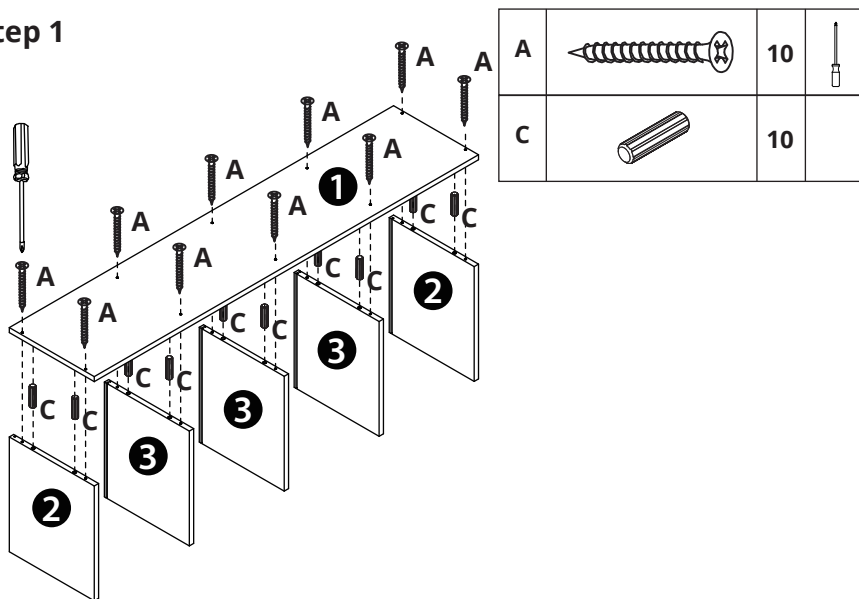



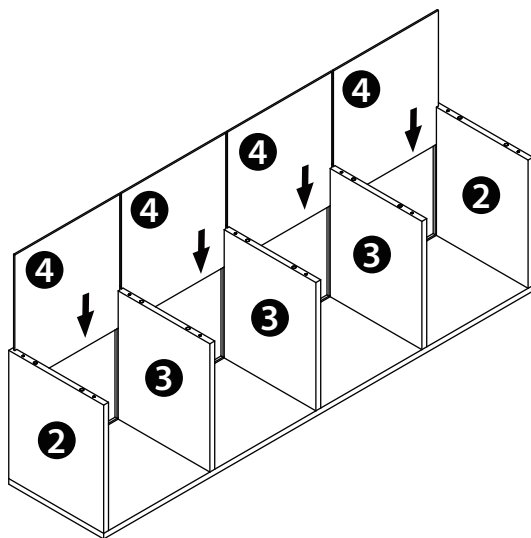

## Step 2

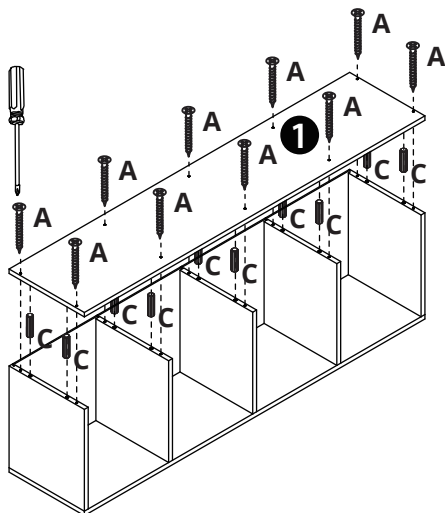

# ASSEMBLY INSTRUCTIONS

## Step 3



A		10	
C		10	

## Step 4

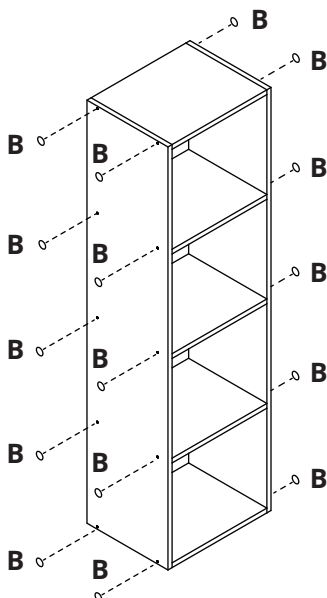



B		20	
---	---	----	--

# ASSEMBLY INSTRUCTIONS

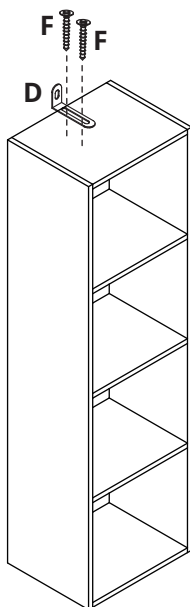
Step 5



F		2	
D		1	

Step 6

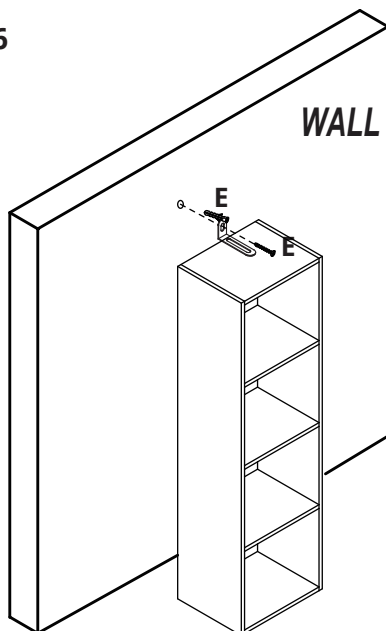

E		1	
---	---	---	--

# ASSEMBLY INSTRUCTIONS

---

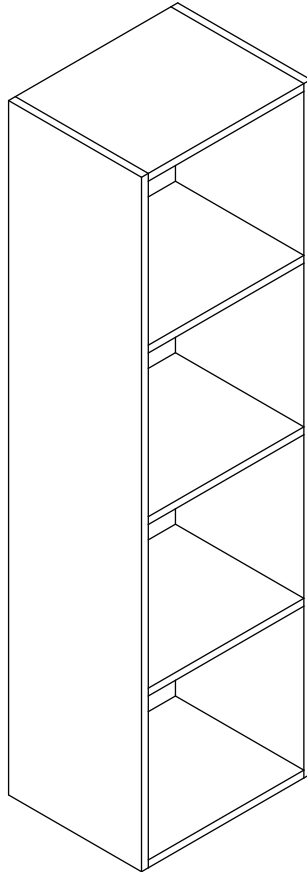

Congratulations! Now you have finished assembling the product. There may be some dust or hand marks on your item, we recommend using a standard wood polish to clean this product.

## **IF YOU FIND A DEFECTIVE PART**

---

We fully stock all parts and components. Any defective part can be quickly replaced. Take note of the defective part number in manual and we will arrange a quick replacement.

## **COPYRIGHT**

---

All material in this instruction manual is copyrighted.

Any unauthorised use may violate worldwide copyright, trademark and other laws.

