

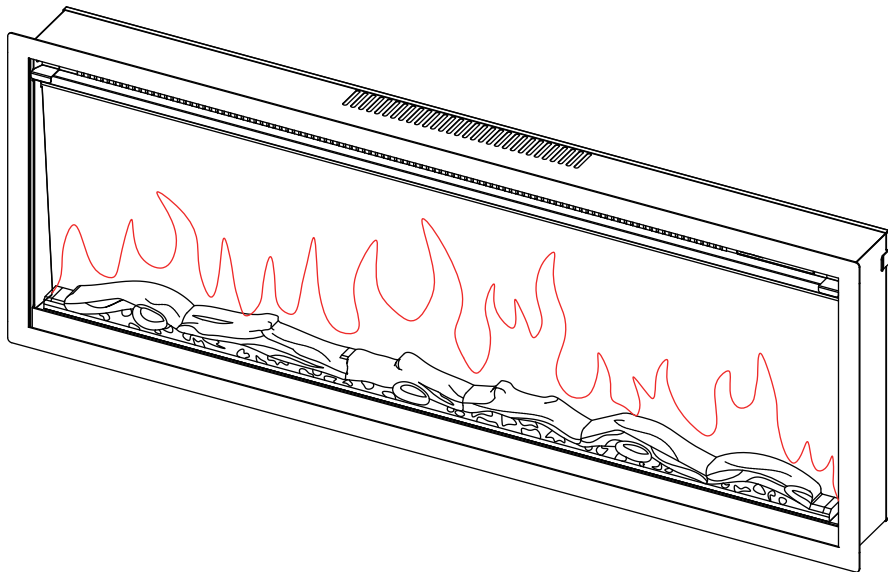



# In Wall Recessed Electric Fireplace

Model Number: (EF700A, EF701A, EF702A, EF703A)

## OWNER'S MANUAL



 <b>WARNING</b>	<p><b>Read and understand</b> this entire owner's manual, including <b>all safety information</b>, before <b>plugging</b> in or <b>using</b> this product. Failure to do so could result in <b>fire</b>, <b>electric shock</b>, or <b>serious personal injury</b>.</p>
 <b>CAUTION</b>	<p><b>Keep this owner's manual</b> for future reference. If you sell or give this product away, <b>make sure this manual accompanies this product</b>.</p>

### **DO NOT RETURN!**

Contact our customer service team for help first.

Email: [service2@richenchina.com](mailto:service2@richenchina.com)

Call: 909-206-6608



## 1. IMPORTANT SAFETY INFORMATION

When using electrical appliances, basic precautions should always be followed to reduce the risk of fire, electric shock, and injury to persons, including the following:

- **Read all instructions before installing or using this heater.**
- This heater is **hot when in use**. To avoid burns, **do not** let bare skin touch hot surfaces. **Keep combustible materials**, such as furniture, pillows, bedding, papers, clothes, etc. and curtains **at least 0.9 m** from the front of the heater and keep them **away from the sides and rear**.
- **Extreme caution** is necessary when any heater is used by or near children or invalids and whenever the heater is left **operating and unattended**.
- **Do not** operate any heater after it malfunctions. Disconnect power at service panel and have heater inspected by a reputable electrician before reusing.
- **Do not** use **outdoors**.
- To disconnect heater, **turn controls to off**, and turn off power to heater circuit at main disconnect panel (or operate internal disconnect switch if provided).
- **Do not insert** or **allow foreign objects to enter any ventilation or exhaust opening** as this may cause an **electric shock** or fire, or **damage the heater**.
- To prevent a possible fire, **do not** block air intakes or exhaust in any manner.
- A heater has **hot** and **arcing** or **sparking** parts inside. **Do not use** it in areas where **gasoline, paint, or flammable vapors** or liquids are used or stored.
- Use this heater **only** as described in this manual. Any other use **not recommended** by the manufacturer may cause fire, **electric shock**, or injury to persons.
- This heater may include an audible or visual **alarm** to **warn** that parts of the heater are **getting excessively hot**. If the alarm sounds (or illuminates), **immediately** turn the heater off and inspect for any objects on or adjacent to the heater that may have blocked the airflow or otherwise caused high temperatures to have occurred. **DO NOT OPERATE THE HEATER WITH THE ALARM SOUNDING (OR ILLUMINATING)**.

- **Risk of electric shock! DO NOT OPEN!** No user-serviceable parts inside!
- **Never modify this appliance.** Doing so could result in personal injury or property damage. Modification of this fireplace **completely voids all warranties.**
- **Always** turn this appliance off before unplugging it from the outlet.
- **Always use** properly grounded, **fused** and polarized outlet.
- **Never** plug this appliance into an outlet that is **old, cracked,** or has any **loose wires or connection.** Plugging this appliance into a faulty outlet could result in **electric arcing** within the outlet that could cause the **outlet to overheat or catch fire.**
- **DO NOT** run **power cord** under carpeting. **DO NOT** cover power cord with throw rugs, runners, or similar coverings. **DO NOT** route power cord under furniture or appliances. Arrange power cord **away from traffic** area, and where it will not be tripped over.

This heater is for use on 120 volts. The cord has a plug as shown at A in Figure below. An adapter as shown at C is available for connecting three-blade grounding-type plugs to two-slot receptacles. The green grounding lug extending from the adapter must be connected to a permanent ground such as a properly grounded outlet box. The adapter should not be used if a three-slot grounded receptacle is available.

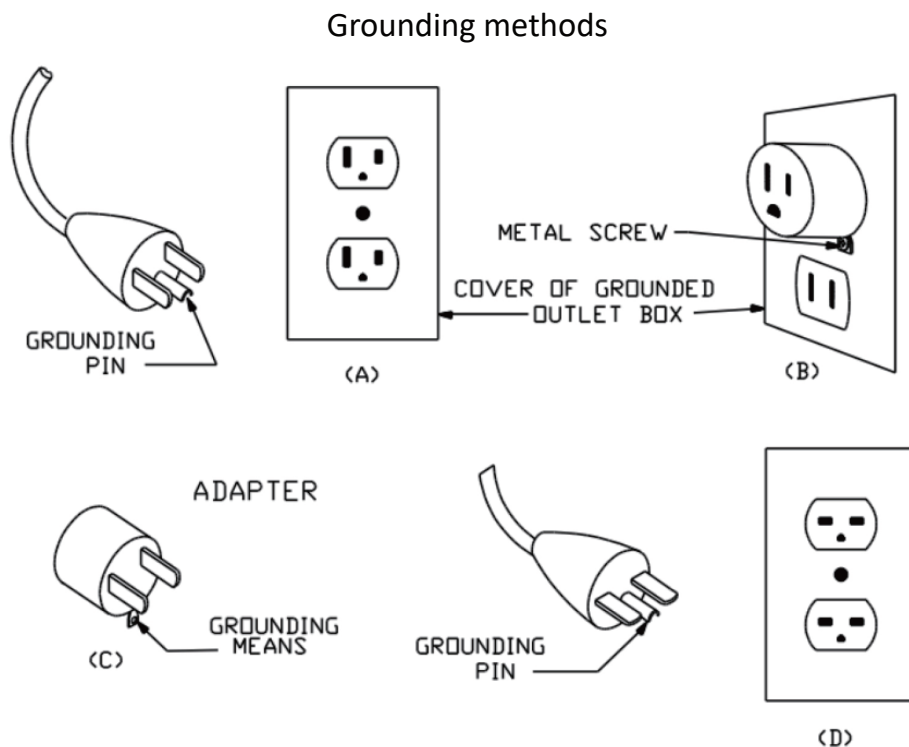

**NOTE: Adaptors are NOT for use in Canada.**

This device complies with part 15 of the FCC Rules. Operation is subject to the following two conditions: (1) This device may not cause harmful interference, and (2) this device must accept any interference received, including interference that may cause undesired operation.

**FCC warning:**

Any Changes or modifications not expressly approved by the party responsible for compliance could void the user's authority to operate the equipment.

**Note:** This equipment has been tested and found to comply with the limits for a Class B digital device, pursuant to part 15 of the FCC Rules. These limits are designed to provide reasonable protection against harmful interference in a residential installation. This equipment generates uses and can radiate radio frequency energy and, if not installed and used in accordance with the instructions, may cause harmful interference to radio communications. However, there is no guarantee that interference will not occur in a particular installation. If this equipment does cause harmful interference to radio or television reception, which can be determined by turning the equipment off and on, the user is encouraged to try to correct the interference by one or more of the following measures:

- Reorient or relocate the receiving antenna.
- Increase the separation between the equipment and receiver.
- Connect the equipment into an outlet on a circuit different from that to which the receiver is connected.
- Consult the dealer or an experienced radio/TV technician for help.

This equipment complies with FCC radiation exposure limits set forth for an uncontrolled environment. This equipment should be installed and operated with minimum distance 20cm between the radiator & your body.

**IC warning**

- English:

This device complies with Industry Canada license-exempt RSS standard(s).

Operation is subject to the following two conditions: (1) This device may not cause interference, and (2) This device must accept any interference, including interference that may cause undesired operation of the device.

This equipment complies with IC RSS-102 radiation exposure limits set forth for an uncontrolled environment. This equipment should be installed and operated with minimum distance 20cm between the radiator & your body.

- French:

Le présent appareil est conforme aux CNR d'Industrie Canada applicables aux appareils radio exempts de licence. L'exploitation est autorisée aux deux conditions suivantes:

1. l'appareil ne doit pas produire de brouillage, et
2. l'utilisateur de l'appareil doit accepter tout brouillage radioélectrique subi, même si le brouillage est susceptible d'en compromettre le fonctionnement.

Cet équipement est conforme aux limites d'exposition aux rayonnements IC établies pour un environnement non contrôlé. Cet équipement doit être installé et utilisé avec un minimum de 20cm de distance entre la source de rayonnement et votre corps.

## SAVE THESE INSTRUCTIONS

### 2. TECHNICAL SPECIFICATIONS

#### Electric Specifications

Model	Volt	Watt(min/max)	Hz	BTU	Amp	Heating Area
EF700A, EF701A, EF702A, EF703A	120V	750/1500	60	5000	12.5	400sq.ft.

#### Product Dimensions

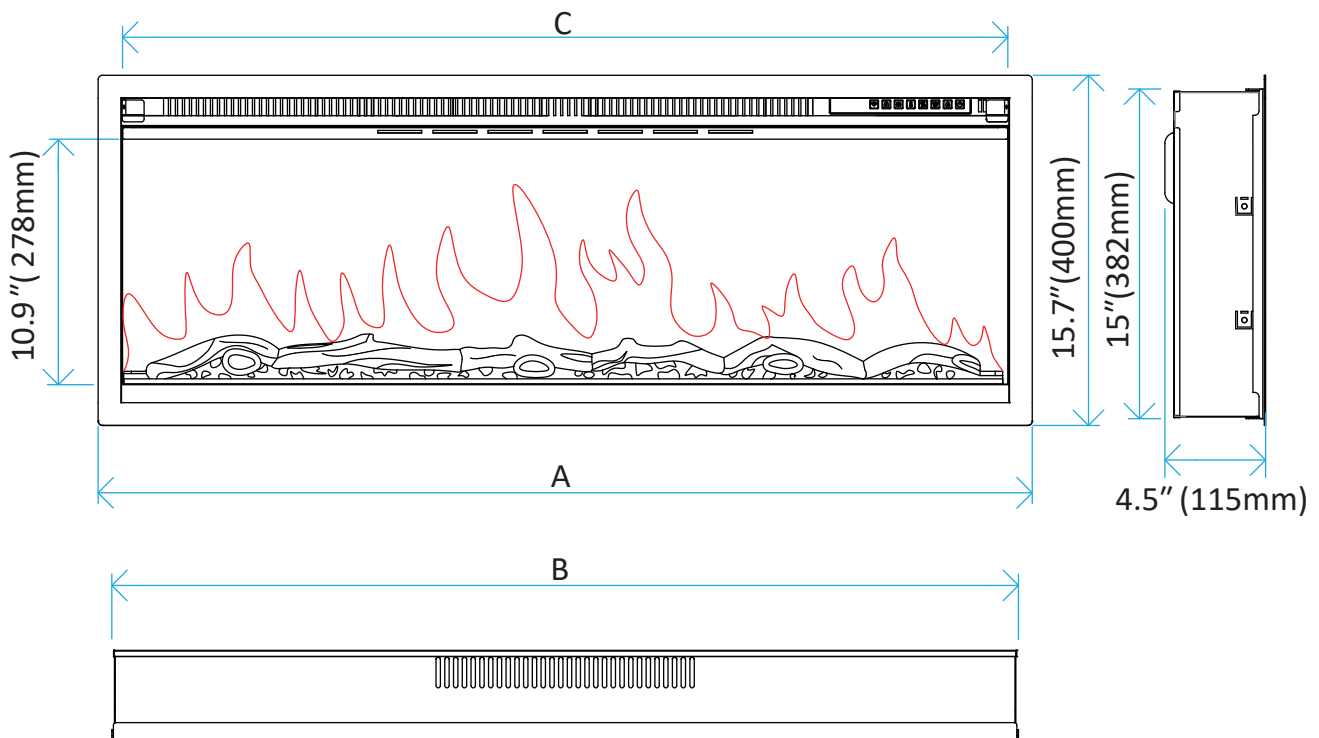

Model	Unit	EF700A	EF701A	EF702A	EF703A
A	inch	42	50	60	68
	mm	1067	1270	1525	1728
B	inch	41	49	59	67
	mm	1042	1245	1500	1703
C	inch	39.6	47.7	57.7	67.7
	mm	1007	1212	1467	1670

### 3. BEFORE INSTALLATION

**Note:**

- Keep the packaging (carton, rapping bag, etc.) for future transportation and/or storage.
- If there is any problem or question, please contact the service team.
- If the unit needs to be returned, please make sure all the spare parts are packed inside and packing as the same as the original packing.

**Check Spare Parts**

- Open the packaging carefully and remove the polystyrene.
- Check all the spare parts are fully received.
- Carefully check if any damages that may have for the spare parts.

**Note: Contact service team for help if there is any part missing or damaged. Email to [service2@richenchina.com](mailto:service2@richenchina.com) or call 909-206-6608.**

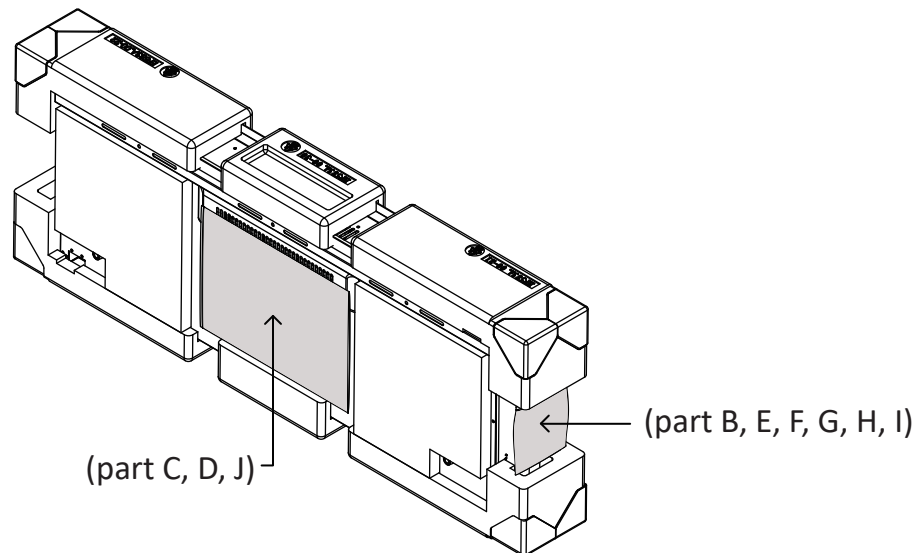

**WARNING:** This carton includes **GLASS! ALWAYS** use **extreme caution** when handling **glass**. Failure to do so could result in **personal injury** or **property damage**.

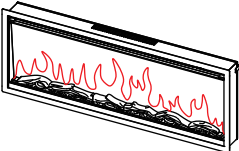
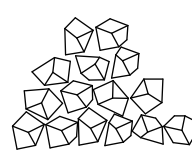
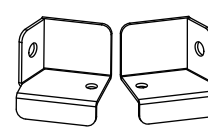
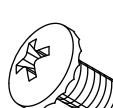
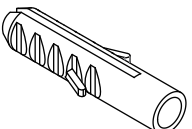
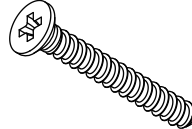
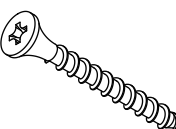
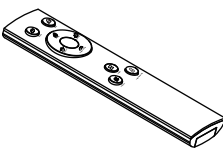
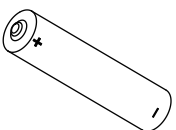
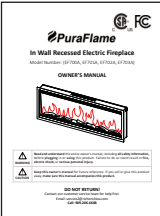
<p>A.</p>  <p>1 x</p>	<p>B.</p>  <p>1 set x</p>	<p>C.</p>  <p>2 x</p>	<p>D.</p>  <p>2 x</p>				
<p><b>Firebox</b></p>		<p><b>Crystal</b></p>		<p><b>Glass Fixer</b></p>		<p><b>Screw M4*8</b></p>	
<p>E.</p>  <p>9 x</p>	<p>F.</p>  <p>9 x</p>	<p>G.</p>  <p>4 x</p>	<p>H.</p>  <p>1 x</p>				
<p><b>Wall Plug</b></p>		<p><b>Screw ST5*40</b></p>		<p><b>Screw ST4*40</b></p>		<p><b>Remote</b></p>	
<p>I.</p>  <p>2 x</p>	<p>J.</p>  <p>1 x</p>						
<p><b>AAA Battery</b></p>		<p><b>Instruction Manual</b></p>					

### Function testing

Please refer to section 5a. Manual Control and 5b. Remote Control to test the appliance first before installation. Should any defects found, please contact service team for help. Call 909-206-6608 or email [service2@richenchina.com](mailto:service2@richenchina.com)

## 4. INSTALLATION INSTRUCTIONS

### Tools Required

A Phillips screwdriver, a drill and a hammer will be needed.

### Location the appliance

Your new electric fireplace may be installed virtually anywhere in your home. However, when choosing a location, ensure that the general instructions are followed.

- For best results, install out of direct sunlight.
- The appliance should be connected to an earthed electrical outlet and it must be easily accessible to allow disconnection.
- Try to avoid any conditions that may cause the fireplace to vibrate, which would result in the automatically turning on or off of the fireplace itself.
- Due to many different finish materials use on walls, it is highly recommended that you consult your local builder before you install this fireplace in the wall.

### Minimum Clearance to Combustibles

Sides.....	0
Floor.....	0
Back.....	0
Top (Mantel or TV) .....	8" Minimum
Front.....	36" Minimum



### Electrical Supply Circuit Requirements

Plan the location of the appliance so that it will have adequate electric power. A 15 amp, 120V/60Hz circuit is required. Additional appliances on the same circuit as this appliance may exceed the current rating of the circuit. A dedicated circuit is not required, but is preferred to prevent circuit breaker trips or fuse failure.

Prepare the outlet close to the right side of appliance. Make sure the outlet is in good condition and the plug must be plugged tightly on the outlet.

**Note:** Place the unit on a soft surface to avoid scratches during below steps and keep all the parts removed carefully.

**1. Remove the wall mounting bracket.**

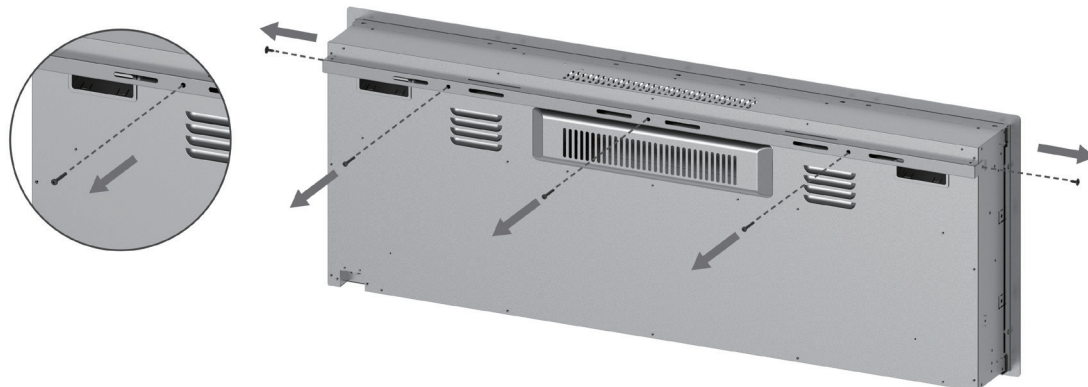

**2. Remove front glass.**

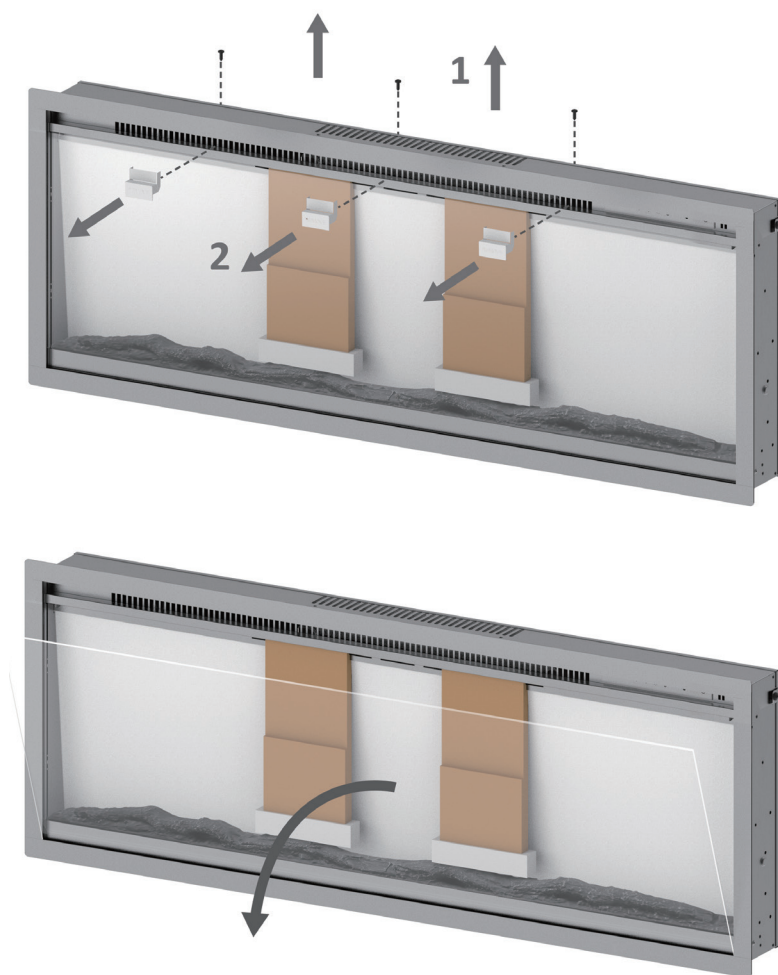

### 3. Remove the fuel bed.



### 4. Prepare power supply.

### 5. Installation.

There are 2 installation types of this appliance: a. wall mounted, b. flush mounted.

#### 5a. WALL MOUNTED INSTALLATION

5a.1 Fix the wall mount bracket on the wall. Put the mounting bracket on the wall where you would like to install the appliance, mark the holes for screws, drill holes on the marks, insert the wall plugs  $\Phi 8*40$  (for masonry wall ONLY) into the holes and fix the bracket by screws ST5\*40.

**Note:** Keep at least 5" on both sides of the wall bracket, 9.8" to top ceiling (if there is) and 13.6" to the floor.

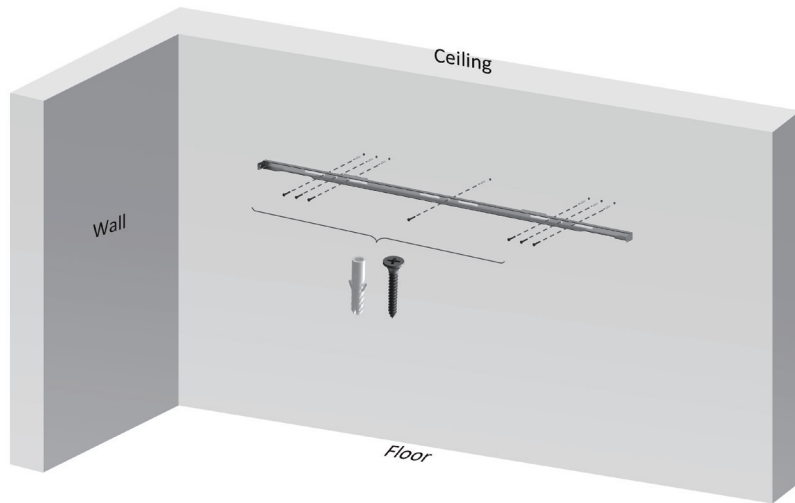

5a.2 Hang on the firebox on the bracket.



5a.3 Use the screws removed before to secure.

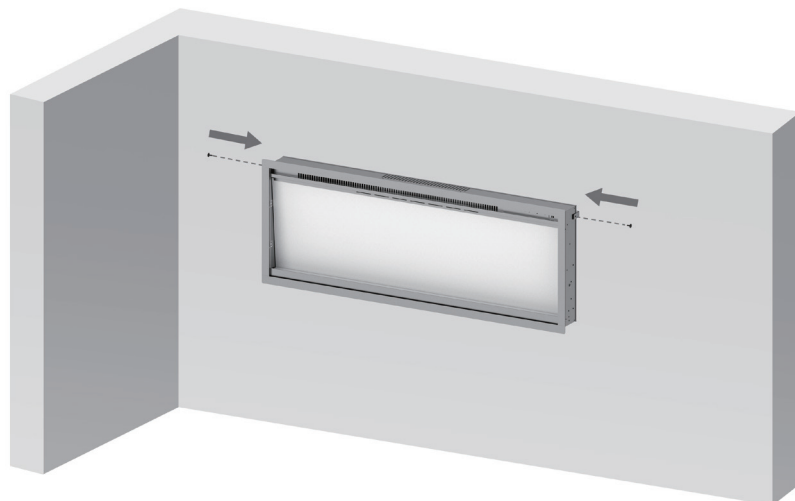

**5b. FLUSH MOUNTED INSTALLATION**

5b.1 Build the framing by 2x6" stud as picture for 50" as an example. The appliance will be supported by the bottom framing. Make sure the bottom framing is solid and level. Leave some gap behind the right stud for electrical supply.

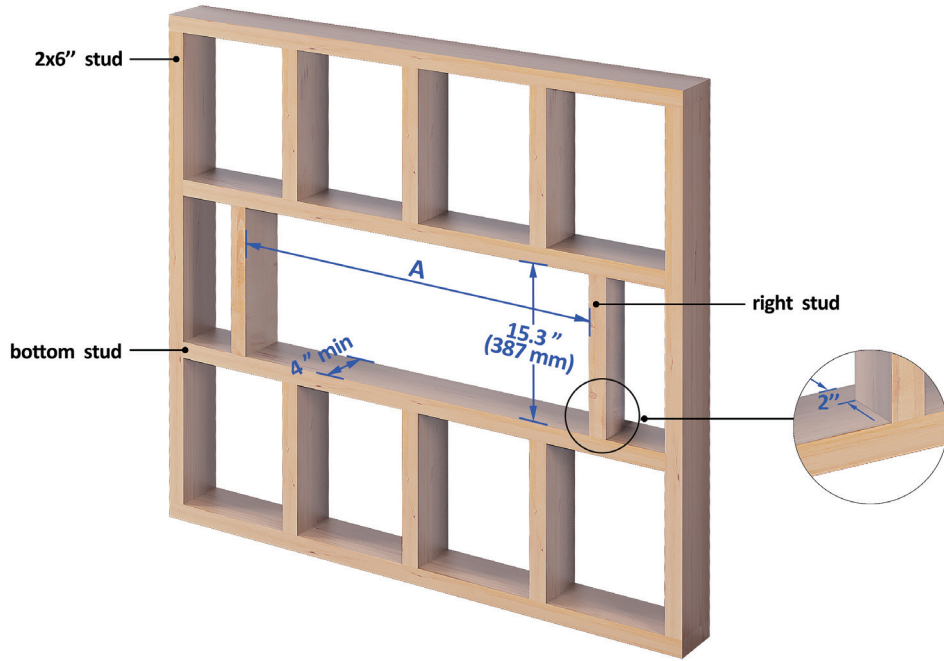

Model	Unit	EF700A	EF701A	EF702A	EF703A
A	inch	41.3	49.3	59.4	67.4
	mm	1049	1252	1507	1710

If you want to stick ledger stone on plasterboard, add one more wood on each side.

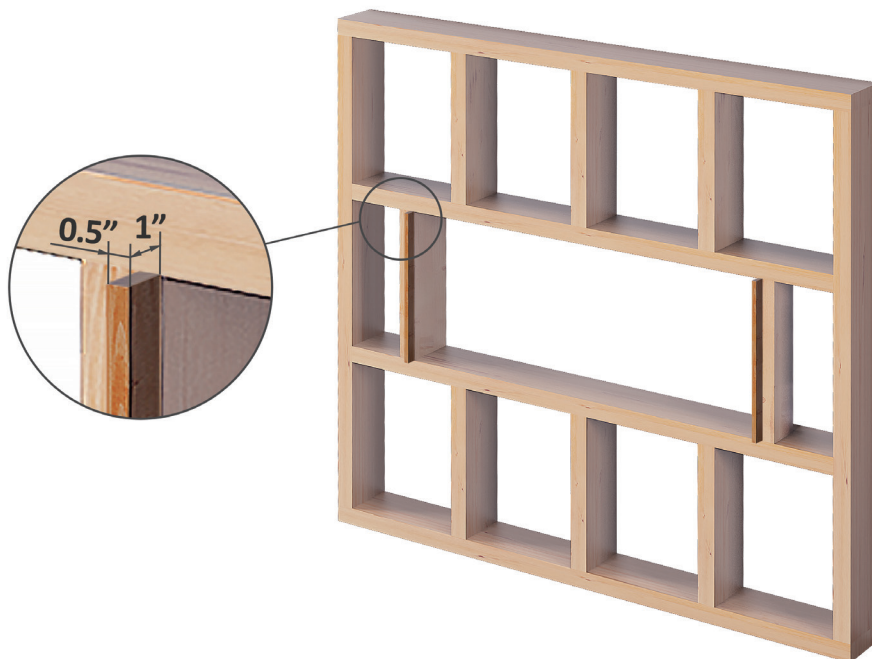

5b.2 Prepare electrical supply.

5b.3 Fix the plasterboard to edge of the framed opening.

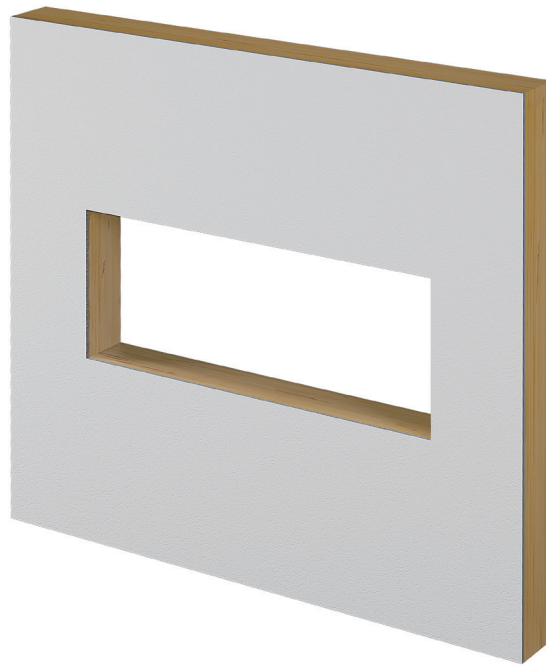

Paint or Wall paper

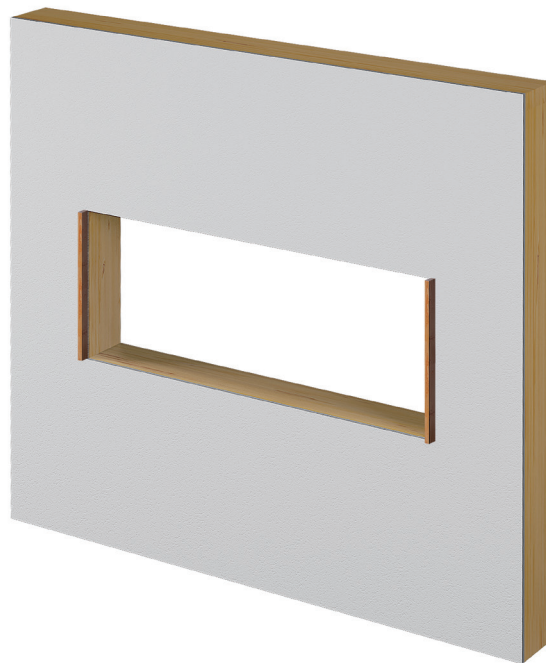

Ledger stone

5b.4 Finish the wall by paint, wall paper or ledger stone.

5b.5 Remove 2 rubber feet on the back.



5b.6 Remove 4 rubber feet at the bottom.



5b.7 Remove 2 screws and take out the left and right inner side panel.





5b.8 Plug the unit to the circuit.

5b.9 Insert the firebox into the opening, fix the fireplace on the side wood stud by screws (ST4x40 4pcs) and fix the panels back with screws.



## 6. Set the fuel bed.

Evenly spread the small clear crystals across the fuel bed or place the log on the fuel bed panel gently.

## 7. Install the glass.



**CAUTION!** The next step required installation of a GLASS panel! Manufacturer recommends that 2 adults install the glass panel. Always use extreme caution when handling glass. Failure to do so could result in personal injury or property damage.

Carefully insert the glass into the slot at the bottom of the firebox, put down the glass slowly. Fix the glass front by 2pcs glass fixers and screws removed before.

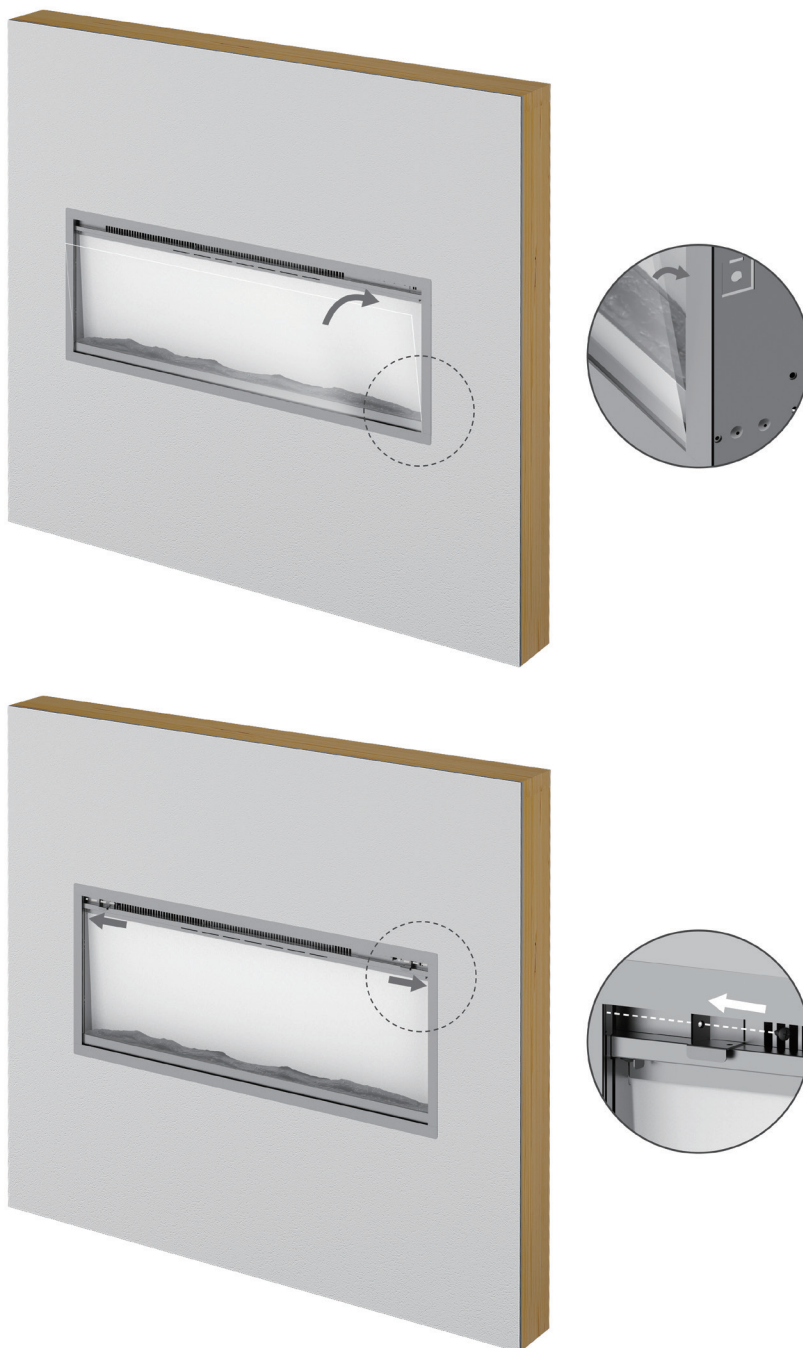

## 8. Finish the installation.

## 5. OPERATION INSTRUCTIONS

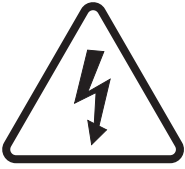







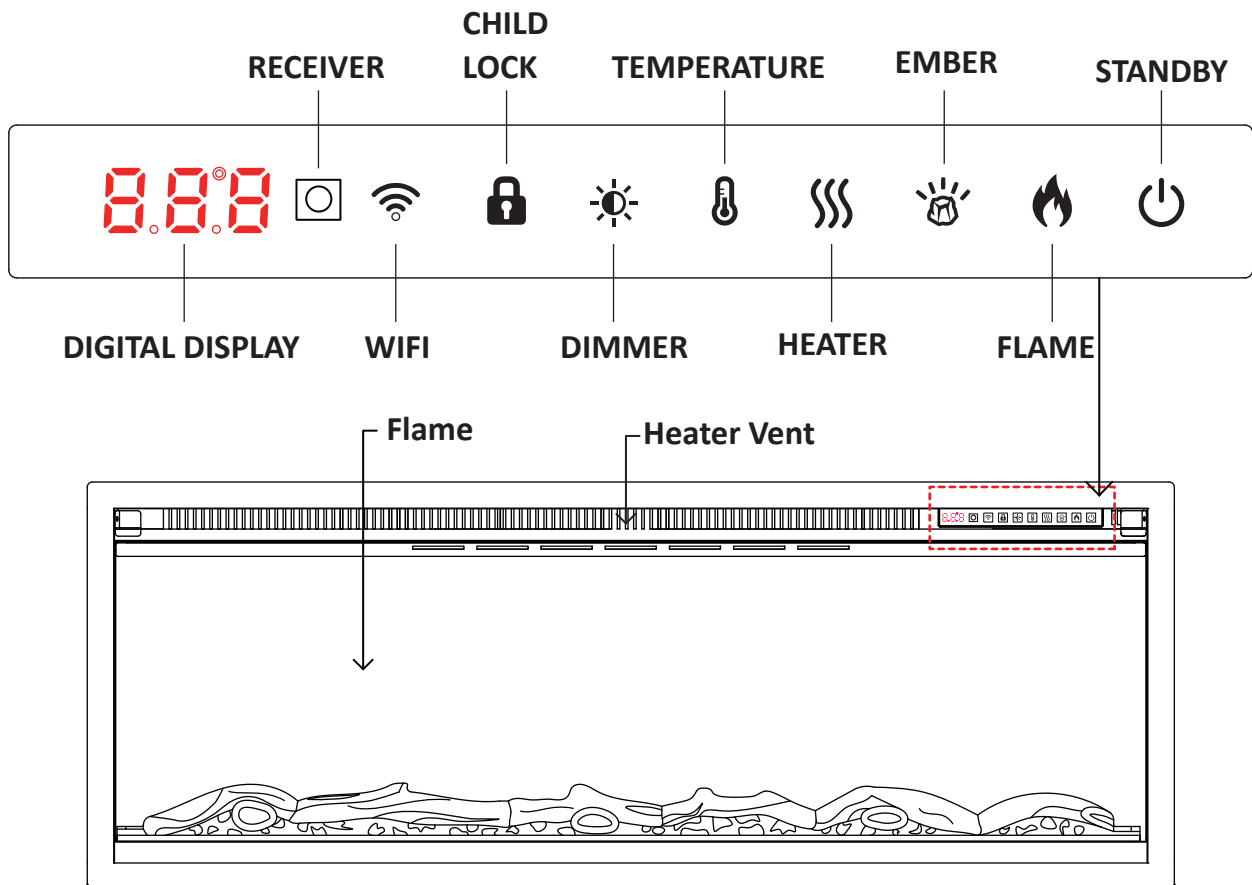

Read and understand this entire owner's manual, including all safety information, before plugging in or using this product. Failure to do so could result in electric shock, fire, serious injury, or death.



**WARNING!** Do not operate the unit if it is damaged or has malfunctioned. If you suspect the unit is damaged, call a qualified service technician to inspect and replace any part of the electrical system if necessary.

### 5a. MANUAL CONTROL





BUTTON	TITLE	FUNCTION
	<b>STANDBY</b>	Turns on the appliance with the last used settings without any heat. Place the appliance into standby mode with all features turned off.
	<b>FLAME</b>	Press to cycle through 12 flame colors, cycle and off setting. <b>Note:</b> Each time a button is pressed on the appliance or on the remote control, an audible beep is emitted. To turn off this feature, keep pressing button <b>FLAME on the unit</b> for 3 seconds.
	<b>TEMPERATURE</b>	Pressing to cycle through the temperature range from 16 to 28°C / 60 to 84°F. <b>Note:</b> Press <b>TEMPERATURE</b> button for 3s to change the temperature unit between °C and °F.
	<b>EMBER</b>	Press to cycle through 12 ember colors, cycle and off setting.
	<b>HEATER</b>	Press to cycle through the heat output options: Low-High-Off.
	<b>DIMMER</b>	Press to cycle through 5 flame/ember brightness levels. <b>Note:</b> Operating this button within 10s of pressing the ember button to adjust the brightness of the ember. In other cases, pressing this button by default adjusts the flame brightness.
	<b>CHILD LOCK</b>	Press to turn child lock on or off. If the child lock is activated while the lights or heating are ON, other button operations will be disabled. If the lights and heating are both OFF, pressing the child lock button will have no effect.
	<b>WIFI</b>	Press to turn WiFi on or off.





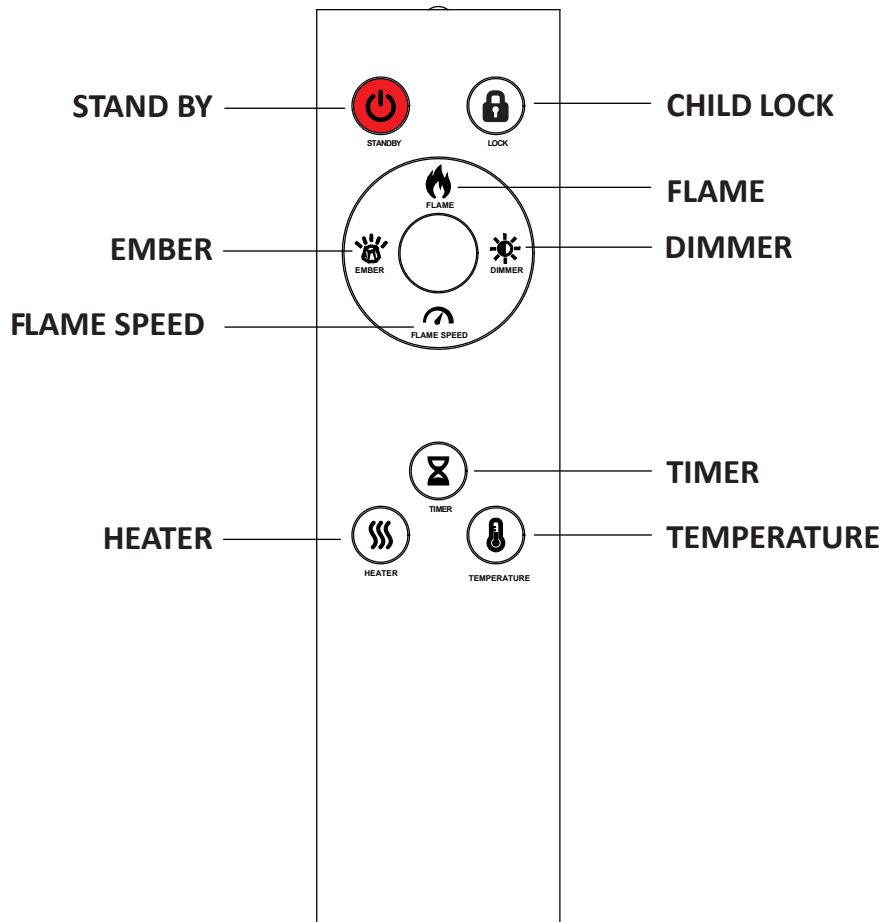

**NOTICE:**

- A harmless slight brief odor may occur during first use or not used for a long period of time.
- There is a brief delay between the heater command and the heating turning ON. when the appliance receives a heater ON command, the appliance blower will turn ON for 10s before the heater turns ON. There is also an 10s delay between heater off and blower shutdown.

**5b. REMOTE CONTROL**



BUTTON	TITLE	FUNCTION
	<b>STANDBY</b>	Turns on the appliance with the last used settings without any heat. Place the appliance into standby mode with all features turned off.
	<b>CHILD LOCK</b>	Press to turn child lock on or off. If the child lock is activated while the lights or heating are ON, other button operations will be disabled. If the lights and heating are both OFF, pressing the child lock button will have no effect.

	<b>FLAME</b>	Press to cycle through 12 flame colors, cycle and off setting.
	<b>EMBER</b>	Press to cycle through 12 ember colors, cycle and off setting.
	<b>FLAME SPEED</b>	Press to cycle through 5 flame speeds.
	<b>DIMMER</b>	Press to cycle through 5 flame/ember brightness levels.
	<b>TIMER</b>	Press to cycle through 0.5H, 1H, 2H, 3H, 4H, 5H, 6H, 7H, 8H and off.
	<b>HEATER</b>	Press to cycle through the heat output options: Low-High-Off.
	<b>TEMPERATURE</b>	Pressing to cycle through the temperature range from 16 to 28°C / 60 to 84°F.

**Note:** In order to prevent the product becoming too hot, there is a 10s delay when turning on the heater and a 10s delay when turning off the heater fan.

### IMPORTANT SAFETY INFORMATION FOR BATTERY

- Two AAA battery are required for the remote control;
- Use the thumb press and push the bar figure on the back cover down simultaneously, then take out the cover and remove the battery or insert the battery, after this place the cover back on the rear of the remote;
- This AAA battery (non-recharged) is not to be recharged;
- Different types of batteries or new and used batteries are not to be mixed;

- Battery is to be inserted with the correct polarity;
- Exhausted batteries are to be removed from the appliance and safely disposed of;
- If the remote control is to be stored unused for a long period, the battery should be removed;
- The supply terminals are not to be short-circuited.

## 5c. APP CONTROL

Visit your APP store (IOS or Android) to download the TUYA SMART APP. Follow the onscreen instructions to create an account. Once installed, follow the procedure below to pair the device with your appliance.

- Start the APP and click “Add Device” on screen. Select “Small Home Appliance” from the list, then select “Electric Fireplace (Wi-Fi)”.
- Ensure the appliance is powered on, then press and hold the Wi-Fi button on the appliance until you hear 3 beeps at EZ mode. At the same time the Wi-Fi button and the fuel bed will blink. If failed at EZ mode, try AP mode. Please press the Wi-Fi button, you will hear 3 beeps, then keep pressing until you hear other 5 beeps enter AP mode.
- Follow the instructions on the APP to input your home network details. Note, your device must also be connected to the same home network what you wish to connect the appliance to.
- Complete setup and link the fireplace to your account.

We have created a very detailed APP Operation Instruction and a video to guide you through the process how to load down the TUYA Smart APP, create an account, pair your appliance to your smart phone and operate the appliance. Scan the QR code to be taken to the Operation Instruction or the video.



## 5d. VOICE CONTROL

**Note:** Before using voice control, ensure that the appliance is connected to the TUYA APP and that Amazon Alexa or Google Assistant APP is installed.

### Amazon Alexa Commands

**Note:** Use your "device name" in place of "my fireplace" below

No.	Function	Commands in Manual
1	Fireplace On/Off	Alexa, turn on <my fireplace> Alexa, turn off <my fireplace>
2	Flame On/Off	Alexa, turn on flame on <my fireplace> Alexa, turn off flame on <my fireplace>
3	Heater On/Off	Alexa, turn on heater on <my fireplace> Alexa, turn off heater on <my fireplace>
4	Heat Mode Low/High	Alexa, set the heat mode on the <my fireplace> to low Alexa, set the heat mode on the <my fireplace> to high
5	Forced Air Heating On/Off	Alexa, turn on forced air heating on <my fireplace> Alexa, turn off forced air heating on <my fireplace>
6	Flame Color	Alexa, set the flame color on the <my fireplace> to 1 (or 2, 3, 4, 5, 6, 7, 8, 9, 10, 11, 12, 13) Alexa, set the flame color on the <my fireplace> to off
7	Flame Speed	Alexa, set the flame speed on the <my fireplace> to 1 (or 2, 3, 4, 5)
8	Flame Brightness	Alexa, set the brightness on the <my fireplace> to 1 (or 2, 3, 4, 5)
9	Ember On/Off	Alexa, turn on ember on <my fireplace> Alexa, turn off ember on <my fireplace>
10	Child Lock On/Off	Alexa, turn on child lock on <my fireplace> Alexa, turn off child lock on <my fireplace>
11	Set Room Temperature	Alexa, set <my fireplace> temperature to N Fahrenheit (N=60-84)

## Google Assistant Commands

**Note:** Use your "device name" in place of "my fireplace" below

No.	Function	Commands in Manual
1	Fireplace On/Off	OK Google, turn on <my fireplace> OK Google, turn off <my fireplace>
2	Flame On/Off	OK Google, activate flame for the <my fireplace> OK Google, cancel flame for the <my fireplace>
3	Heater On/Off	OK Google, activate heater for the <my fireplace> OK Google, cancel heater for the <my fireplace>
4	Heat Mode Low/High	OK Google, set heat mode on <my fireplace> to low OK Google, set heat mode on <my fireplace> to high
5	Forced Air Heating On/Off	OK Google, activate forced air heating for the <my fireplace> OK Google, cancel forced air heating for the <my fireplace>
6	Flame Color	OK Google, set flame color on <my fireplace> to color 1 (or 2, 3, 4, 5, 6, 7, 8, 9, 10, 11, 12, 13)
7	Flame Brightness	OK Google, set brightness on <my fireplace> to 1 (or 2, 3, 4, 5)
8	Ember On/Off	OK Google, activate ember for the <my fireplace> OK Google, cancel ember for the <my fireplace>
9	Child Lock On/Off	OK Google, activate child lock for the <my fireplace> OK Google, cancel child lock for the <my fireplace>
10	Set Room Temperature	OK Google, set <my fireplace> temperature to N Fahrenheit (N=60-84)

## 6. CARE AND MAINTENANCE



**ALWAYS** turn the heater **OFF** and unplug the power cord from the outlet before cleaning, performing maintenance, or moving this fireplace. Failure to do so could result in electric shock, fire, or personal injury.

### Cleaning



**NEVER** immerse in water or spray with water. Doing so could result in electric shock, fire, or personal injury.

### **Metal:**

- Buff using a soft cloth, slightly dampened with a citrus oil-based product.
- **DO NOT** use brass polish or household cleaners as these products will damage the metal trim.

### **Glass:**

- Use a good quality glass cleaner and dry thoroughly with a paper towel or lint-free cloth.
- **NEVER** use abrasive cleansers, liquid sprays, or any cleaner that could scratch the surface.

### **Plastic:**

- Wipe gently with a slightly damp cloth and a mild solution of dish soap and warm water.
- **NEVER** use abrasive cleansers, liquid sprays, or any cleaner that could scratch the surface.

### **Vents:**

- Use a vacuum or duster to remove dust and dirt from the heater and vent areas.
- Clean the exterior of the fireplace with a slightly damp cloth or duster.

### Maintenance



**Risk of electric shock! DO NOT OPEN! No user-serviceable parts inside!**



**ALWAYS** turn the heater **OFF** and unplug the power cord from the outlet before cleaning, performing maintenance, or moving this fireplace. Failure to do so could result in electric shock, fire, or personal injury.

### **Electrical and Moving Parts:**

- The fan motors are lubricated at the factory and will not require lubrication.
- Electrical components are integrated in the fireplace and are not serviceable by the consumer.

### **Storage:**

- Store heater in a clean dry place when not in use.

### **Replacement parts:**

- Use only replacement parts supplied by the manufacturer. Use of any other parts, or modifying the fireplace in any way, will void all warranties.
- No internal parts are replaceable or serviceable.

## **7. LIMITED WARRANTY**

This warrants to the original purchaser that this product is free from defects in material and workmanship as of the date of purchase and that it will, under normal use and proper care, remain so for one year from the date of purchase. Missing or initially defective parts will be replaced free of charge during the period of this limited warranty. If parts are unavailable, comparable replacement of refund will be given. The original dated sales receipt is required for all warranty claims. This warranty does not cover damage which has occurred during transport from the point of purchase to the consumer's home. This warranty does not cover glass, light bulbs, batteries, transportation, labor, or other issues not associated with the manufacture of the product.

**This product is for residential use only. Any and all commercial use of this product voids all warranties, and frees the manufacturer from all liability.**

Read and understand all assembly and operating instructions, and all safety information and warnings, before use. The following will void this warranty: Damage caused from tampering with, modifying, or altering the fireplace insert in any manner; Damage due to incorrect assembly, improper care, misuse, or abuse; Damage from being used with the wrong power source; Water damage; Damage caused from this insert being used outdoors; Damage caused from this insert being used for excessive periods of time; Damage caused by the insert being used in a commercial application; Damage from use as a primary heat source; Other misuse or abuse not specifically listed herein.

**This product is not intended to be used as a primary heat source. It is for supplemental heating purposes only.**

# 8. SCHEMATIC DIAGRAM

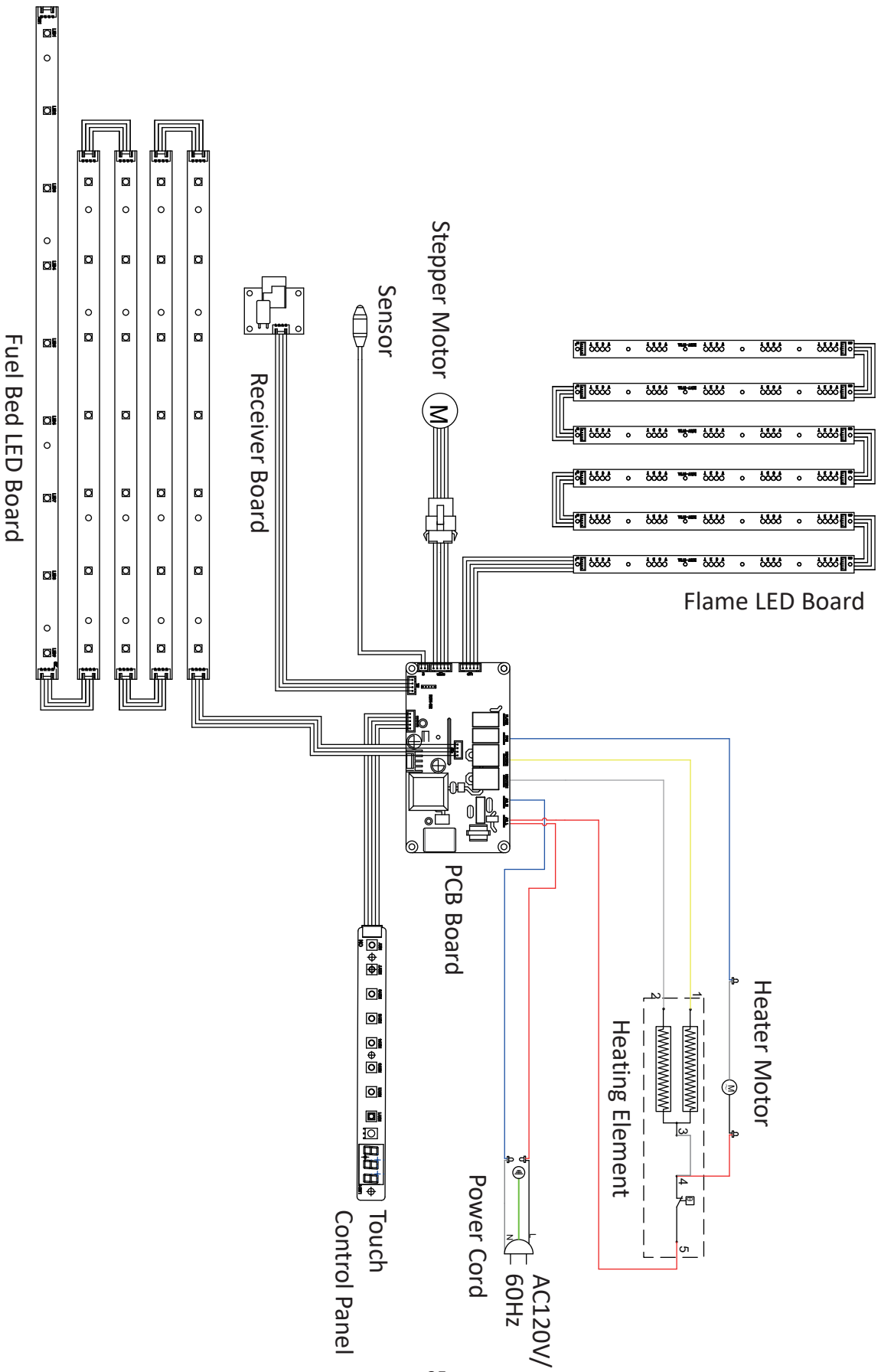

**Ningbo Richen Electrical Appliance Co., Ltd.**

Address: No.19, Yongdinghe Road, Xiapu, Beilun, Ningbo, Zhejiang, P.R.China

**[www.puraflame.com](http://www.puraflame.com)**