







DUO PANEL

Twin • Full
Queen • King

Examine all packaging material for small parts that may have come loose during shipment. Periodic checks are recommended to insure that all components are in proper position, tight and free from damage. Keep this assembly instruction for future reference. Adult assembly is required. The product is designed for residential use only.

HARDWARE LIST

- A (8) 2-1/2" Sunk Bolts
- B (4) 1" Allen Bolts
- C (4) Spring Washers
- D (4) Flat Washers
- E (4) Nuts
- F (2) Foot Glides
- G (1) Allen Wrench

PART	QTY	HARDWARE	PART	QTY	HARDWARE	PART	QTY	HARDWARE
A	8		B	4		C	4	
D	4		E	4		F	2	
G	1							

PARTS LIST

- H (2) End Caps
- I (2) Check Rings
- J (2) Leg Extensions
- K (1) Grill
- L (2) Finials
- M (2) Posts

STEP 1

Begin assembly by attaching Grill (K) to Post (M) using End Cap (H) on the top, Check Ring (I) on the bottom and secure both with Sunk Bolt (A). Repeat step for the other side. Tighten all bolts with Allen Wrench (G) provided.

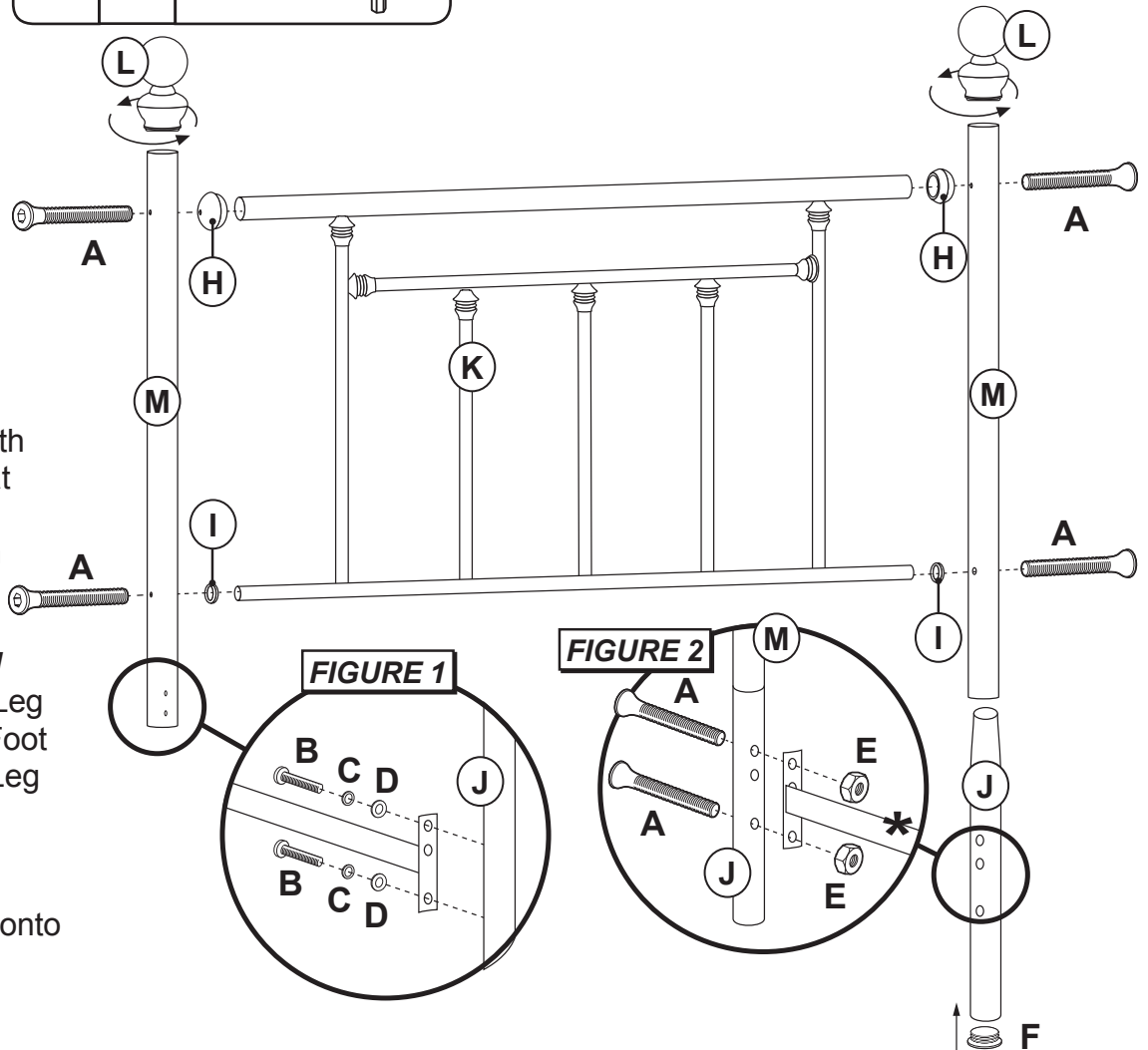

STEP 2 - For Headboard

Next slide Posts (M) into Leg Extensions (J) and slide Foot Glides (F) into bottom of Leg Extensions (J).

STEP 3

Next push the Finials (L) onto the top of Posts (M).

STEP 4 - Figure 1 - For Footboard

Attach side rail to Post (M) using 2 Allen Bolts (B), 2 Spring Washers (C) and 2 Flat Washers (D) per side. Tighten all bolts with Allen Wrench (G) provided.

STEP 5 - Figure 2 - For Headboard

Attach side rails to Leg Extensions (J) using 2 Sunk Bolts (A) from behind and 2 Nuts (E) from the front per side.