

*** NOTICE BEFORE ASSEMBLY ***

Please choose the **CHAISE** will be on
the **LEFT** or **RIGHT** hand side.

#Assembly Instruction I : CHAISE ON THE LEFT

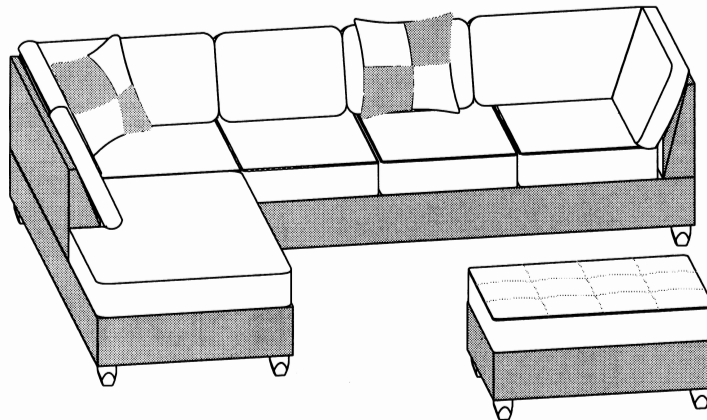

(See Rear Page)

#Assembly Instruction II : CHAISE ON THE RIGHT

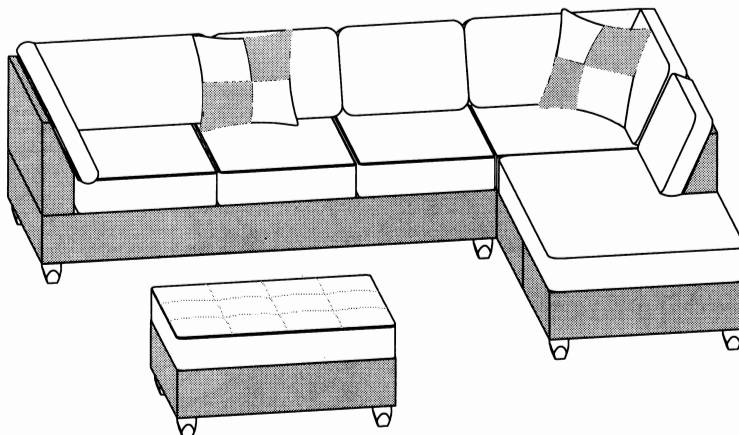

(See Rear Page)

PARTS LIST

BOX-1

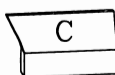
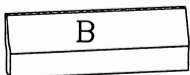
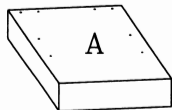

BOX-2

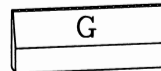
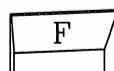
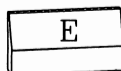
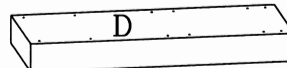

BOX-3

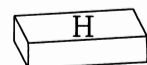



1.  x12

2.  x12

3.  x12

4.  x12

5.  x1

 x12

Insturction I :CHAISE ON THE LEFT

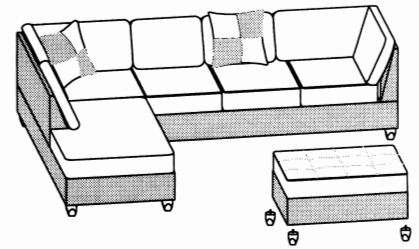
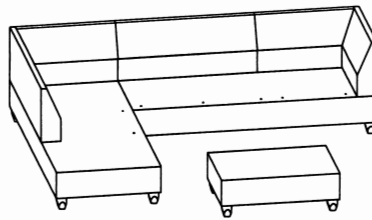
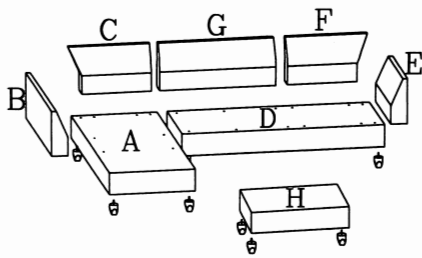

BOX-1

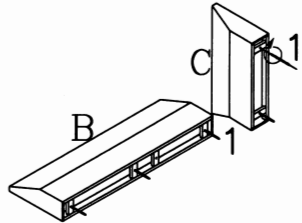
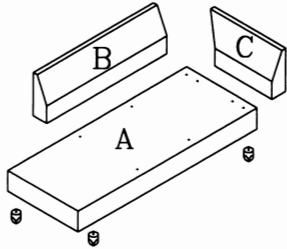

USE "2ND" HOLE TO THE "LEFT"

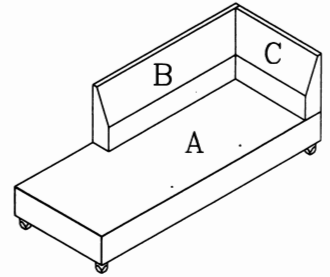
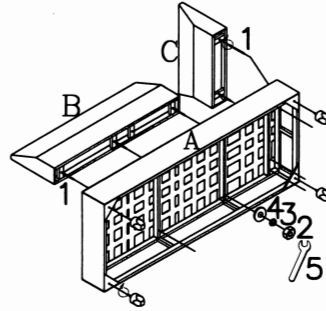

BOX-2

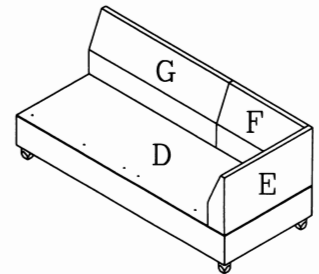
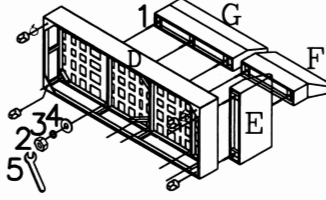
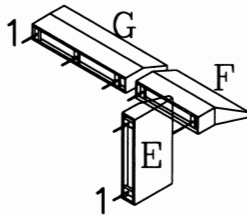
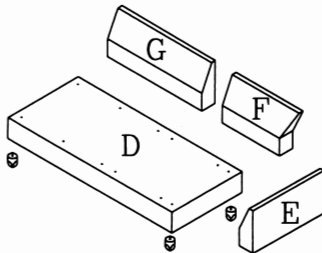

Insturction II :CHAISE ON THE RIGHT

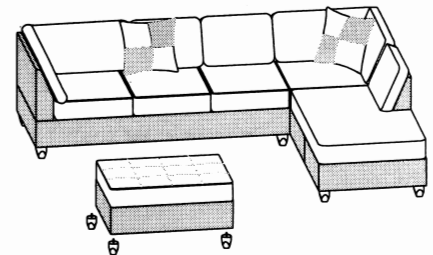
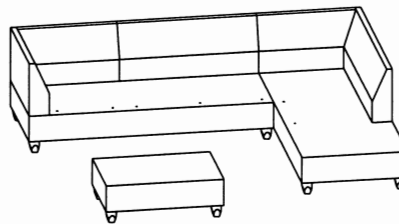
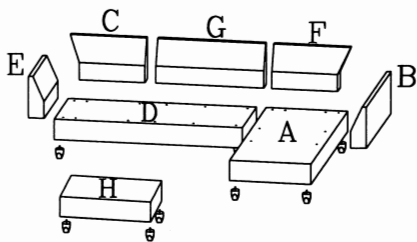

From "BOX-2"

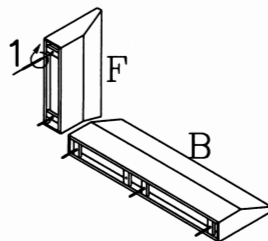
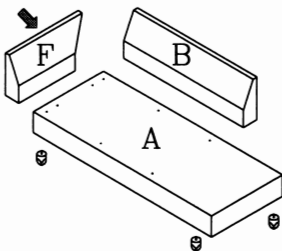

USE "2ND" HOLE TO THE "RIGHT"

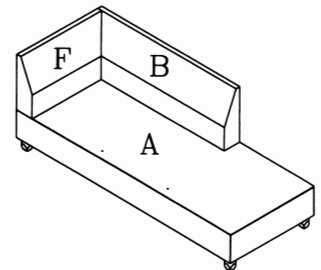
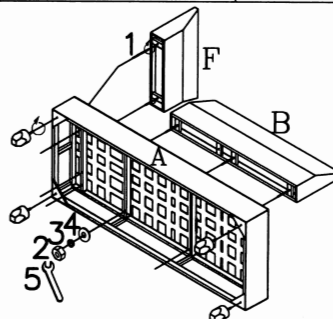

From "BOX-1"

