

Assembly Instructions

BENCH

CAUTION: You must read this before you proceed.

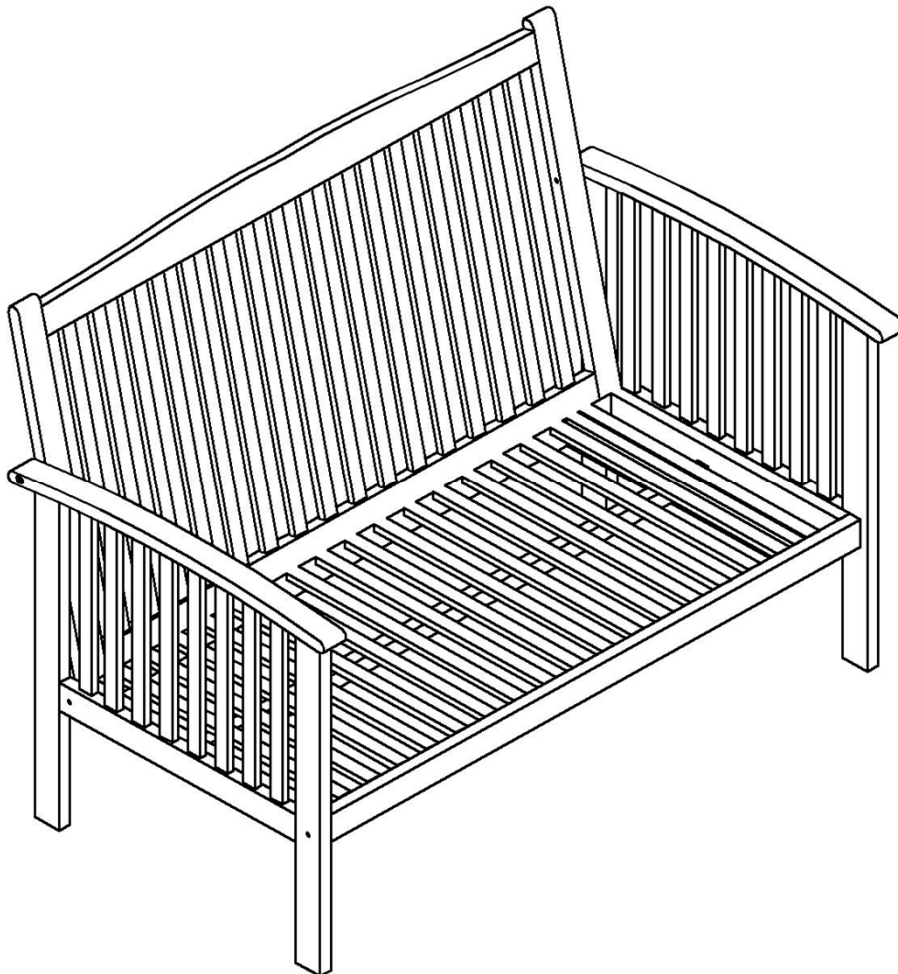





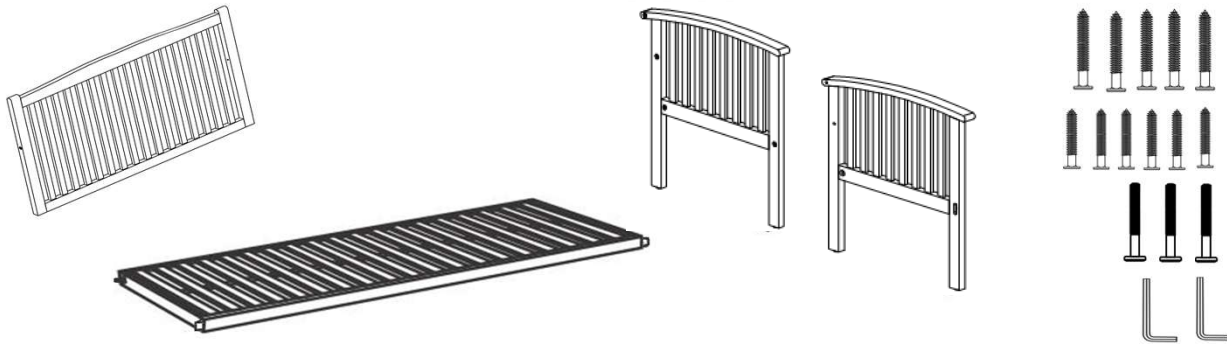

CAUTION : This Bench is NOT a TOY. Keep your child / children at bay in the process of assembly.

For turning the Bench and to prevent damage to the Bench, 02 persons may be needed to execute this action.



Assembly Preparation

Before Beginning Assembly:



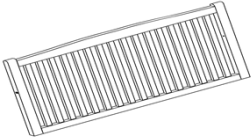
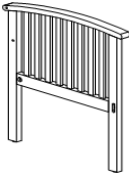
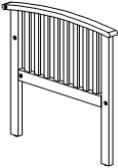

-  • Read instructions, cover to cover-
-  • Have 2 adults on hand for assembly-
-  • Do not assemble on flooring or carpet-
-  • Assemble on a clean non-marring surface (packing foam)-
-  • Save all packaging until finished-

Parts List

No.	Picture	Description	Qty
A		Backrest Panel	1
B1		Right Arm with Leg	1
B2		Left Arm with Leg	1
C		Seat Panel	1

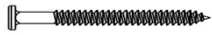
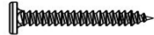
Hardware

No.	Picture	Description	Qty
①		Screw (M7*70mm)	5
②		Screw (M7*60mm)	6
③		Bolt (M6*70mm)	3
④		Allen Wrench	2

Assembly Steps

OVER VIEW

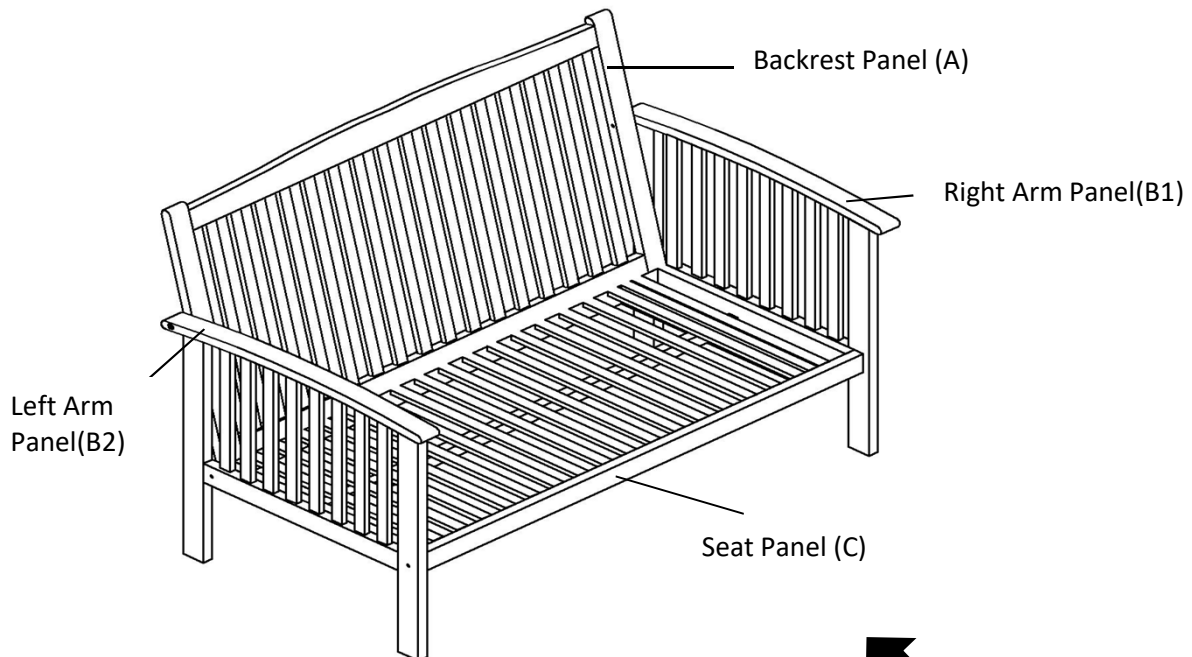

FRONT VIEW

This Bench has multiple parts and may require up to some 30 minutes to assemble. To give you an overview of the Bench, the above picture is to help you put the various parts into perspective. Please read through the instructions here below to familiarise the parts and steps before assembly.

Step 1

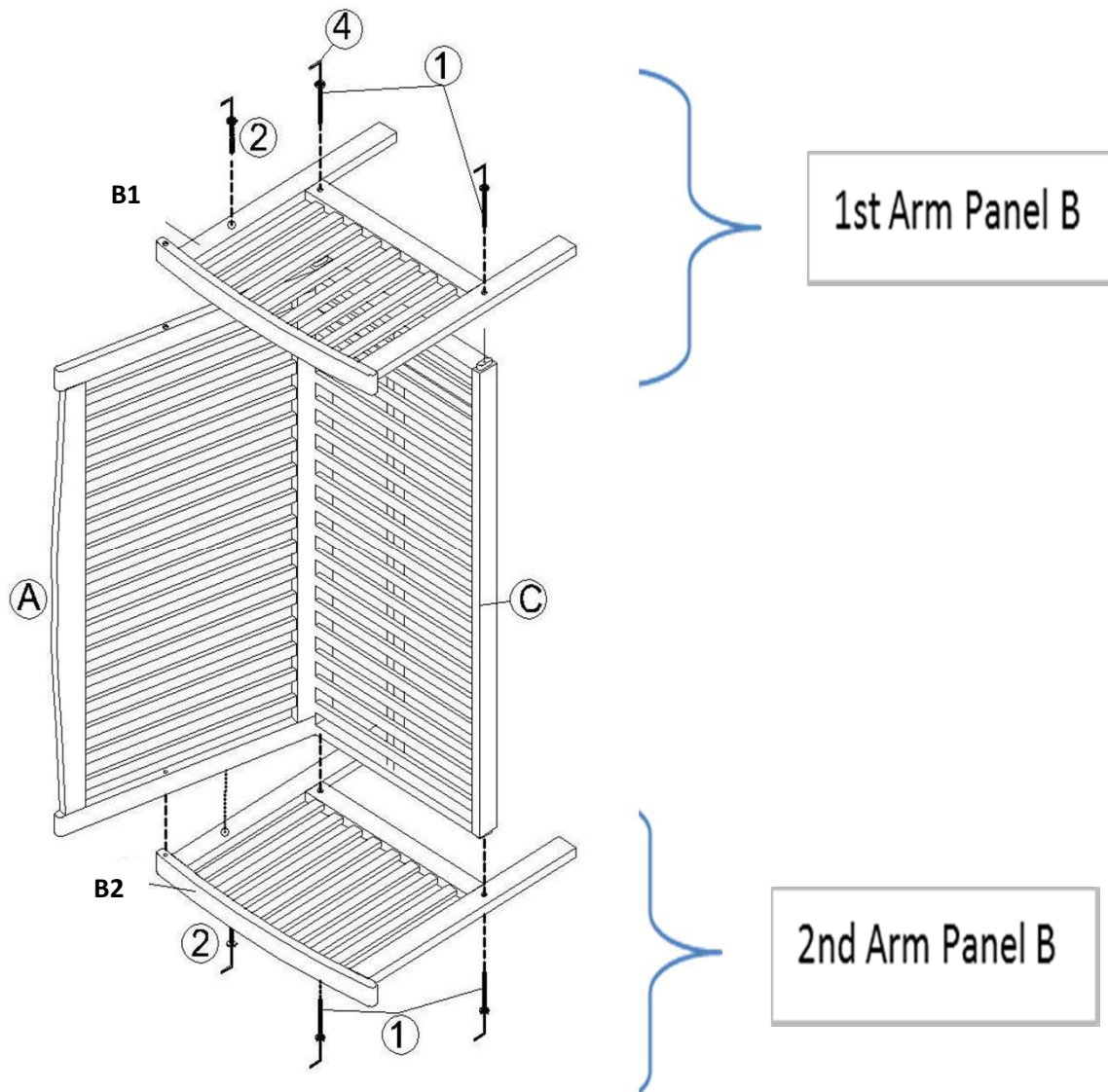

The best place to assemble this arm Bench is on a flat surface, eg., floor. Position Parts Backrest (A) and Seat Panel (C) as shown in picture above.

Affix 1st Right Arm Panel (B1) (facing skywards), as shown above.
Attach Arm Panel(B1) and Backrest Panel(A) by using 1 Screw(2)+Allen Wrench(4)

Attach Arm Panel(B1) and Seat Panel(C) by using 2 Screws(1)+Allen Wrench(4)

Then, flip chair to rest on 1st Arm(B1) so that 2nd Arm (B2) is now facing skywards.

Repeat the same process by affixing Screws to designated points.

CAUTION: DO NOT TIGHTEN SCREWS

Step 2

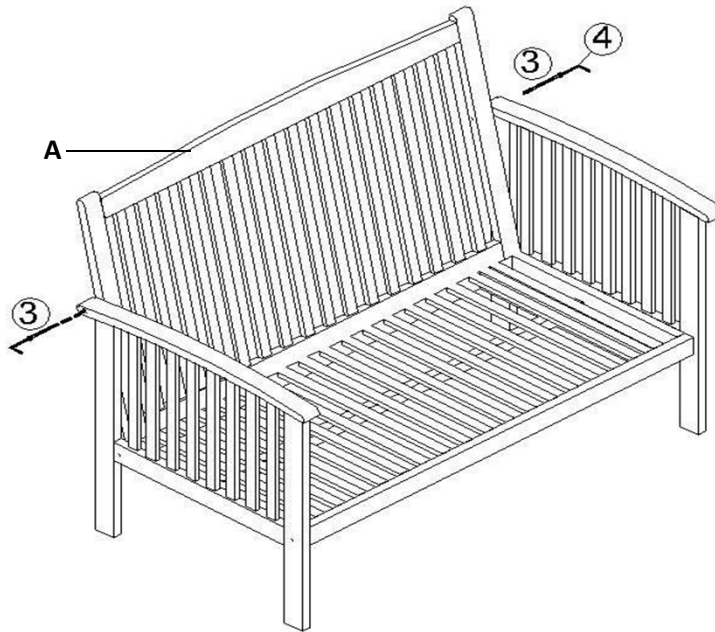

Use Bolt (③) with Allen Wrench (④) to affix the top of the Backrest (A) to the Armrests on both sides as shown.

DO NOT TIGHTEN BOLTS

Step 3

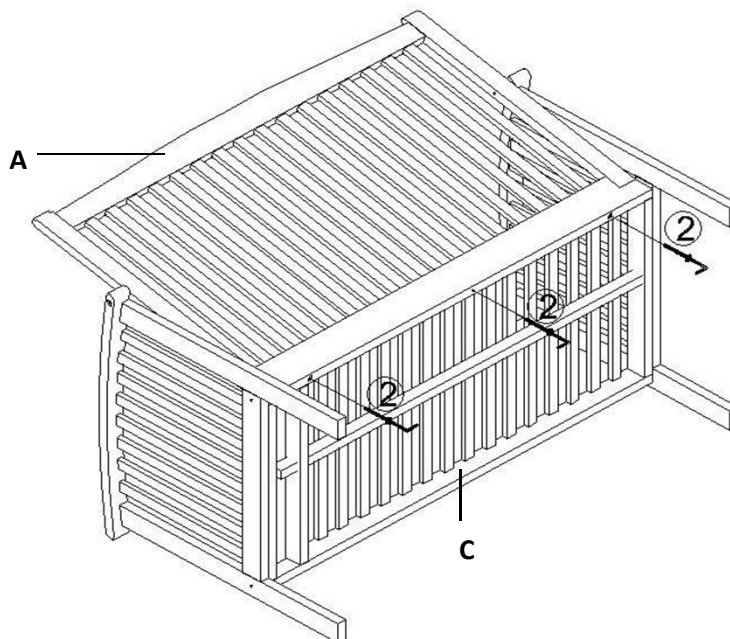

BACK VIEW OF BENCH.

Use Screw (②) and Allen Wrench (④) to attach Backrest Panel (A) and Seat Panel (C).

DO NOT TIGHTEN SCREWS

Step 4

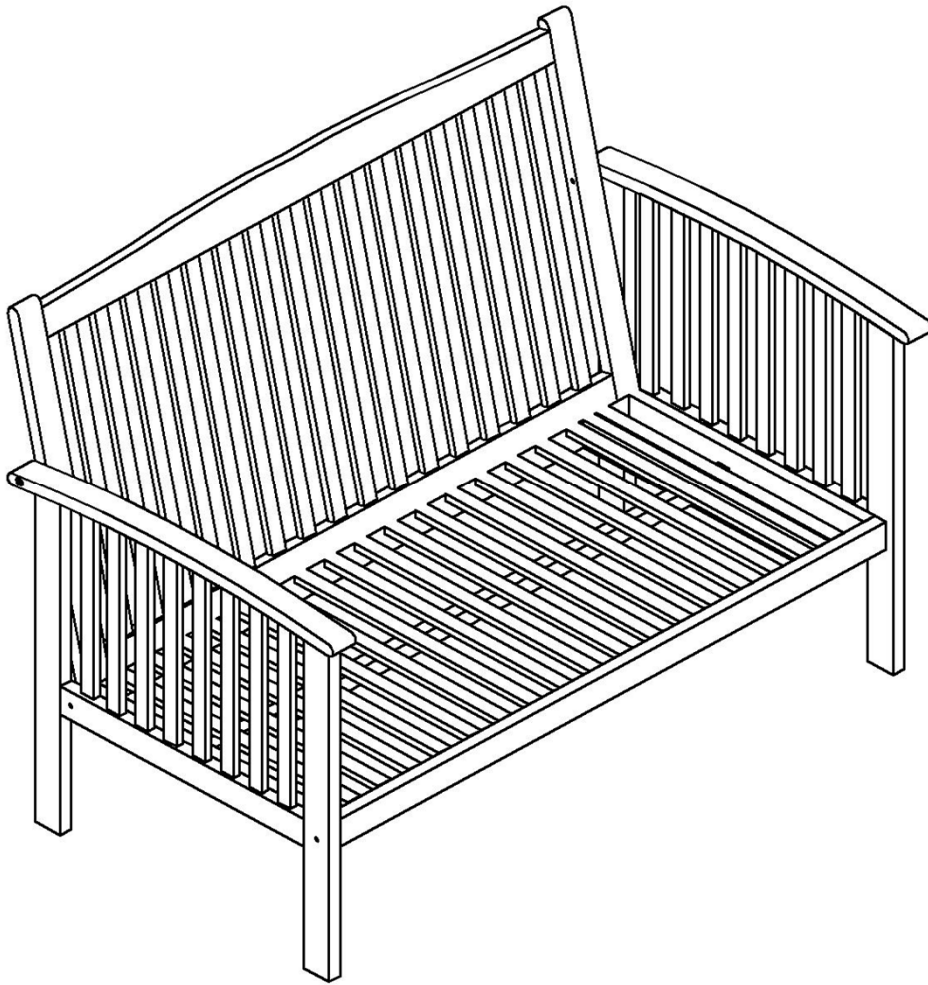

Turn the Bench right side up.









Inspect it and make sure all parts are adequately connected.

Ensure all bolts and screws are fully locked into position and secured.

The Bench is ready to be used.

This Bench can only be used on a flat, level surface.

Care & Maintenance

- ⊗  ● Do not put hot items directly on furniture surface.
 - ⊗  ● Do not clean furniture with harsh cleansers or polish.
 - ✓  ● To obtain the longest lifespan of your outdoor products, minimizing exposure to direct sunlight is recommended.
 - ⊗  ● Children should not climb or jump on the furniture.
 - ⊗  ● Do not write on furniture without a padded barrier to protect the surface.
 - ✓  ● To obtain the longest lifespan of your outdoor products, avoid extended and lengthy exposure to rain, snow, and direct sunshine. Whenever possible cover the product and /or place under patio or awnings.
 - ⊗  ● Not for commercial use. For residential use only.
 - ⊗  ● Stains may be removed with mild soap solution and damp cloth.
 - ✓  ● Dust and pick-up spills using a clean, non-colored, lint-free cloth .
-