

Thank you for your purchase!

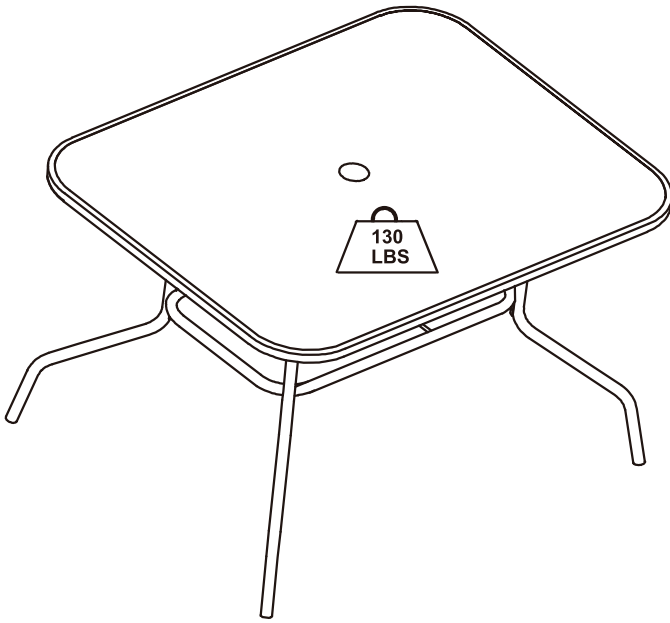

## Rectangular Tempered Glass Metal Table with Umbrella Hole

### ASSEMBLY INSTRUCTIONS

#### Before You Begin:

Please identify all component parts and hardware pieces required before you begin. Carefully remove all of the components from the packaging and set aside for assembly. Assemble on a soft surface to prevent scratching during assembly.

#### Caution:

Tighten all components securely before use. Failure to do so may result in personal injury. DO NOT use any sharp objects to open plastic wrapped components as damage to product or components may result.

#### Warning:

**CHOKING HAZARD** - Small Parts. Adult Assembly Required.









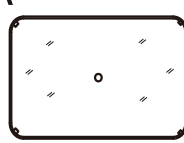

#### DO NOT ALLOW CHILDREN TO CLIMB ON FURNITURE

Serious or fatal injuries can occur from furniture tipping over. You must install Tipping Restraint Hardware (where included) to help prevent the unit from tipping and causing accidental injury, instability, death or damage. The tipping restraint is intended only as a safety measure, it is not a substitute for proper adult supervision.

To help prevent furniture from tipping over it must be permanently attached to the wall. Anti-Tip Safety Wall Straps suitable for the unit weight and wall materials (if not included) should be purchased and installed.

---

# ASSEMBLY INSTRUCTION

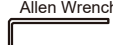
<b>A</b> Glass Top  1PC	<b>B</b> Lower Frame  1PC	<b>C</b> Upper Frame  1PC	<b>D</b> Table Leg  4PCS	<b>E</b> Screw  M6*55 4PCS
<b>F</b> Screw  M6*50 4PCS	<b>G</b> Washer  M6 8PCS	<b>H</b> Nut  M6 8PCS	<b>I</b> Plastic Cushion  4PCS	 Wrench 1PC
			<b>J</b> Umbrella Hole Cap  1PC	 Allen Wrench 1PC

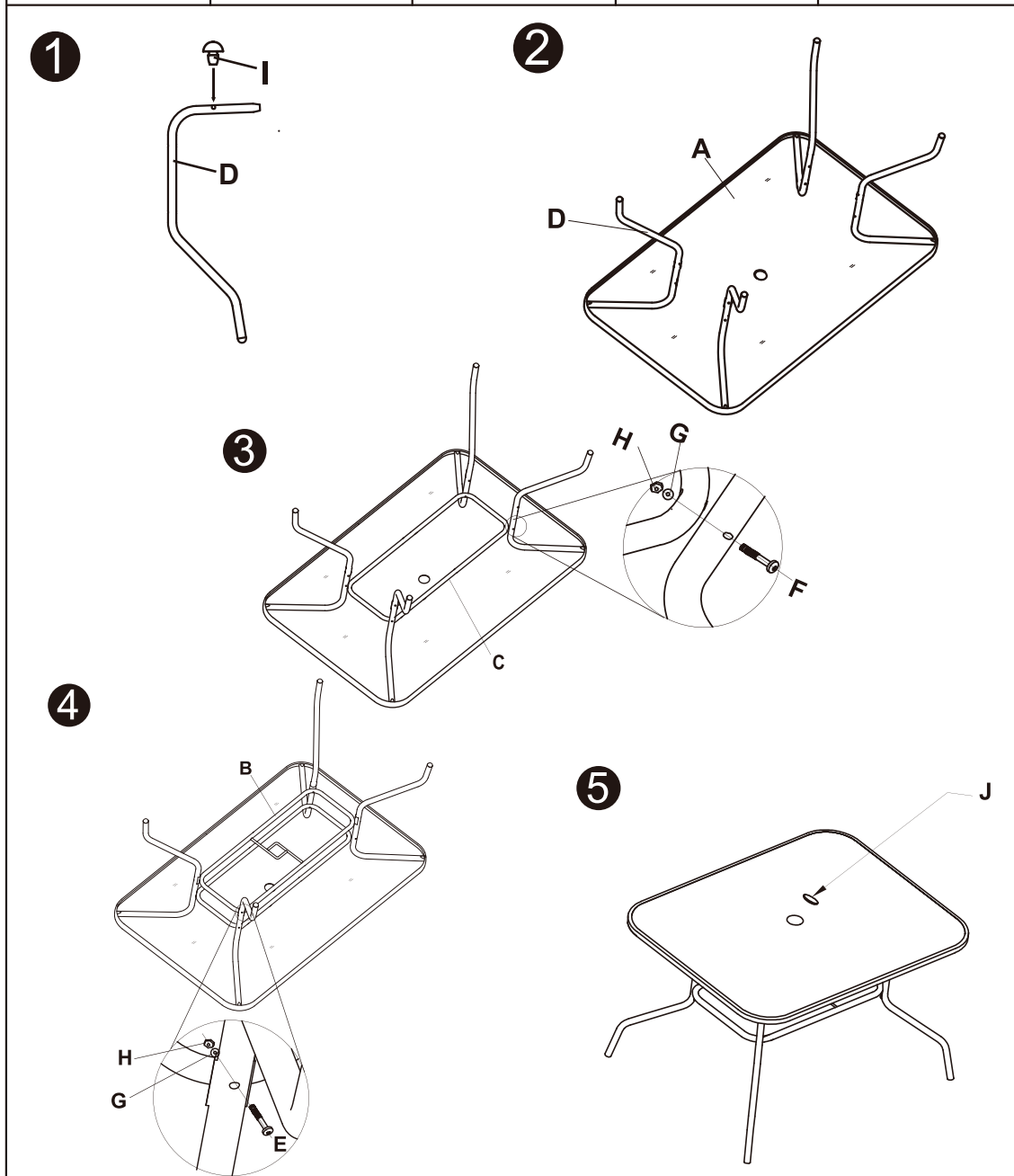

**ASSEMBLY TIPS:** Gently pull on the legs to align the holes and insert screws. Do not fully tighten until all screws, washers, and nuts are in position .

## Quality and Safety Guidelines

- Please follow the static and dynamic weight capacity limits provided on this item. If you are unsure of the weight capacities for this product, email us
- Please use this item on a stable, level surface only. All table legs/feet should contact the flooring surface when in use. Do not use this item if any instability is detected.
- For maintenance instructions and replacement parts, please email us
- Please do not sit, climb or stand on this item.
- Do not slide the item when moving it.
- This product should not be used as a TV stand.
- Please inspect this product regularly to make sure there are no damaged or worn parts. Also inspect to make sure all hardware is tightened correctly and securely. For inspection instructions, please email us
- If any parts are damaged or worn, please stop using the product. Repair this product with manufacturer supplied parts only.
- Store indoors away from moisture. For additional storage instructions, please email us