

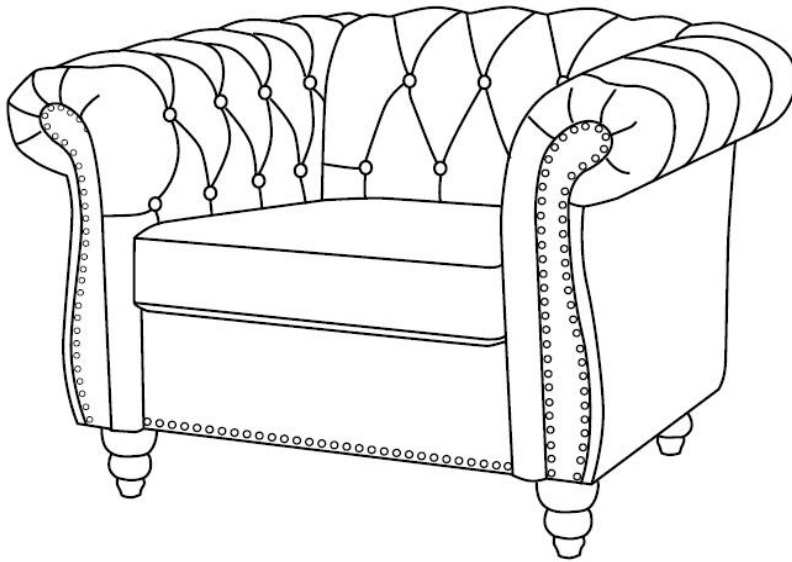



Assembly Instructions

Note: Please help to read my instruction before you ready to assemble.



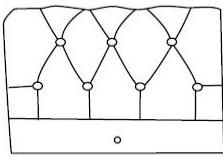
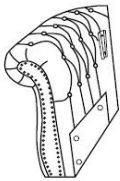
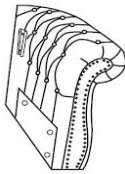
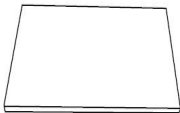

Chair









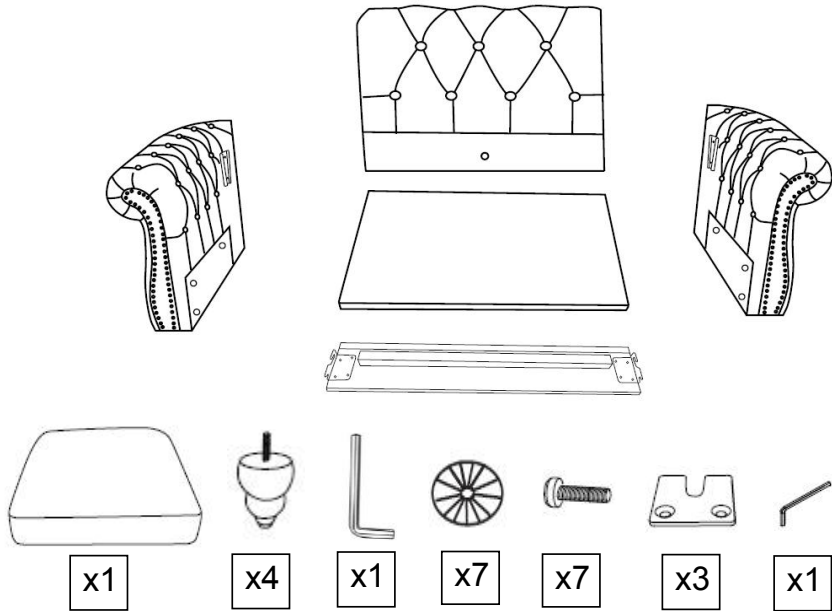

Part List

Label	Picture	Description	QTY (PCS)
A		Backrest	1
B		Left Armrest	1
C		Right Armrest	1
D		Seat	1
E		Front Rail	1
F		Seat Cushion	1
G		Leg	4

Hardware

①		Plastic Washer	7
②		Allen Wrench	1
③		Bolt(M6*20mm)	7
④		Metal Bracket	3
⑤		Allen Wrench(S4)	1

Assembly Preparation

All Including:	
	<div style="display: flex; justify-content: space-around; align-items: flex-end;"> <div style="text-align: center;"> x1</div> <div style="text-align: center;"> x4</div> <div style="text-align: center;"> x1</div> <div style="text-align: center;"> x7</div> <div style="text-align: center;"> x7</div> <div style="text-align: center;"> x3</div> <div style="text-align: center;"> x1</div> </div>

NOTICE:

- Please read the instruction from cover to cover in detail.Thanks.
- Installed by at least two adults
- To avoid damaging your furniture , Please don't assemble on flooring or carpet.
- Please assemble on a clean non-marring surface, example for packing foam.
- Saving all packaging until have finished.

Assembly Steps

OVERVIEW

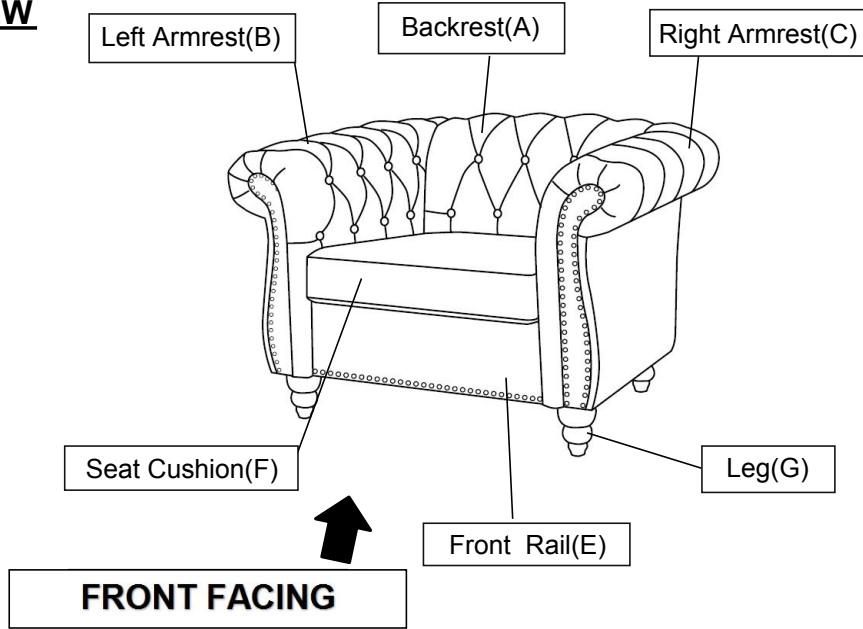

This Chair has multiple parts and may require up to 60 minutes to assemble. To give you an overview of the Chair parts, the above picture is to help you put the various parts into perspective. Please read through the instructions below to familiarise yourself with the parts and steps before assembly.
Note: It is recommended that you have an adult partner to assist during the entire assembly process.

Step 1

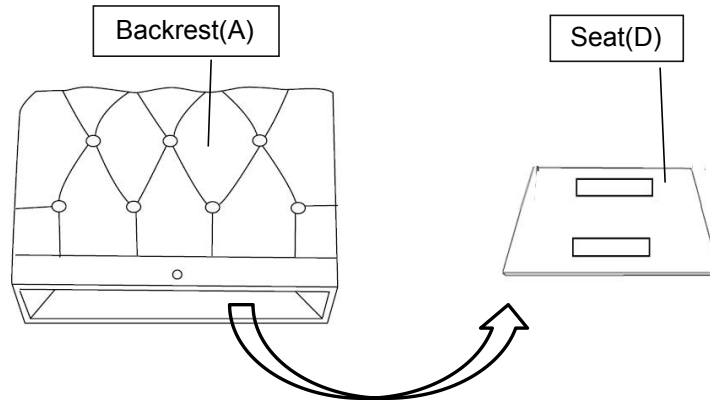

Open the carton and place all the parts on a clean, non-marring surface.
Remove Seat(D) from the bottom of Backrest(A).

Step 2

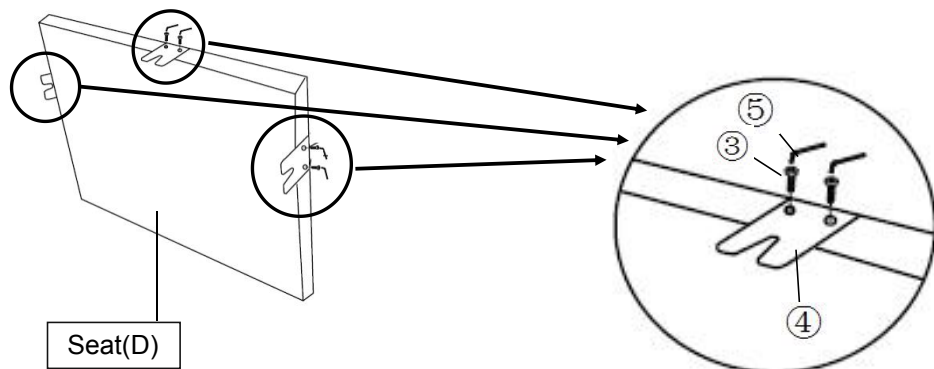

Install the Metal Bracket(4) with Bolt(3), Allen Wrench(5) on the Seat(D).

Step 3

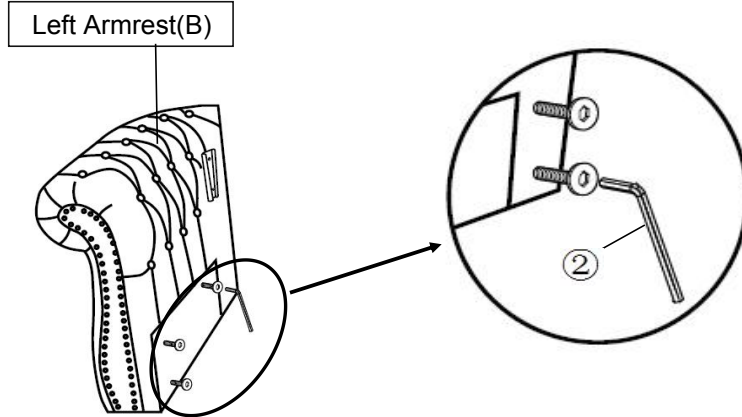

Loosen the 3 bolts in Left Armrest(B) around half inch by Allen Wrench(2). Repeat the same step to loosen 3 bolts in Right Armrest(C).

Step 4

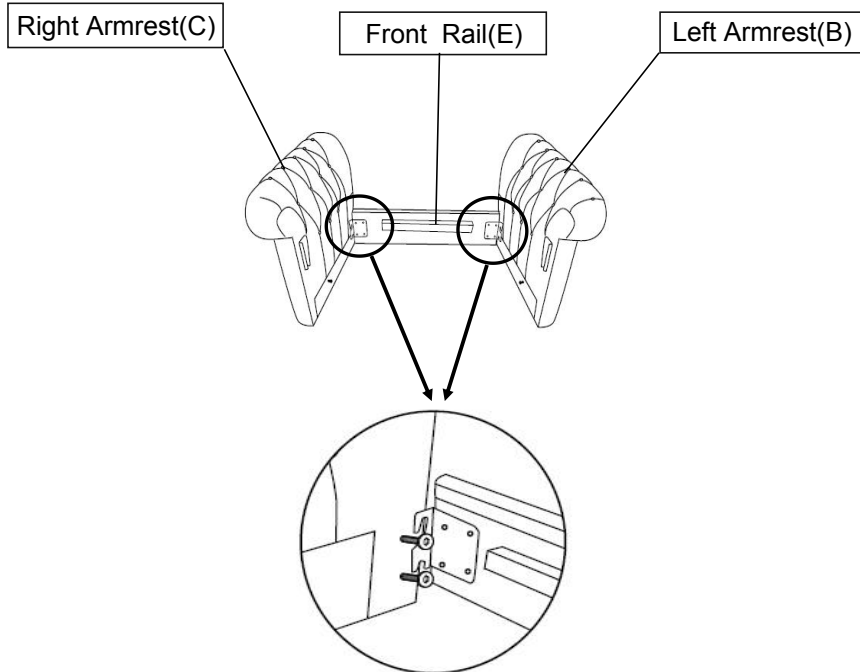

With the assistance of your partner, slide the hook in the end of Front Rail(E) into the bolts on the Left Armrest(B) and Right Armrest(C), as shown in Picture.

Step 5

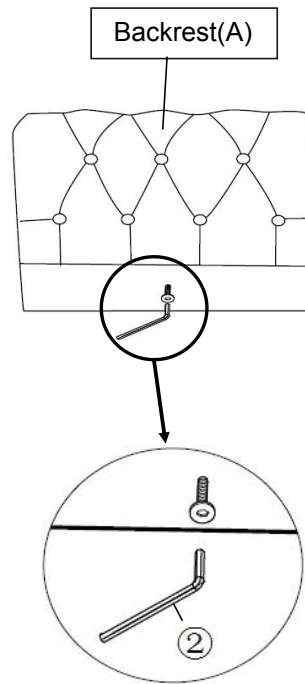

Loosen the bolt in Backrest(A) around half inch by Allen Wrench(②).

Step 6

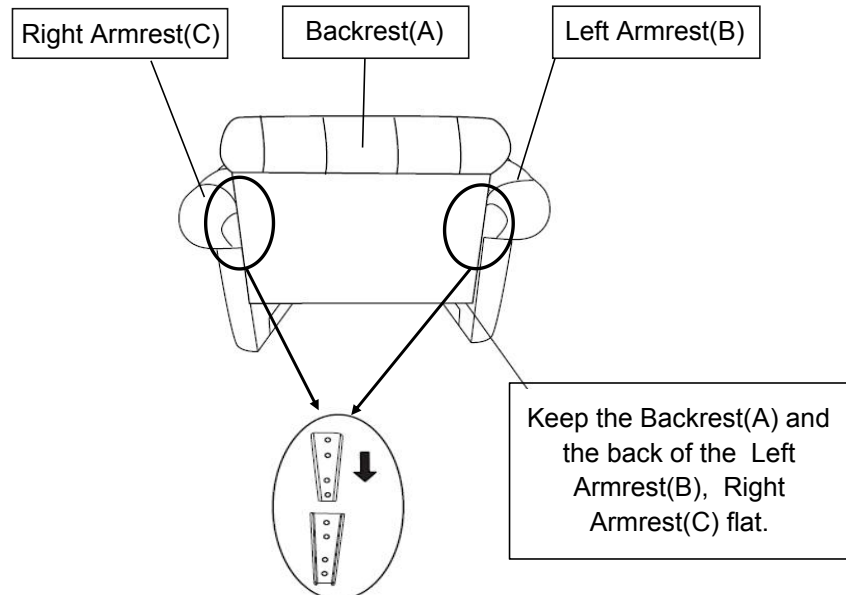

Slide the Tapered Connectors on the Backrest(A) into the Tapered Connectors on the Left Armrest(B) as shown in the picture.

Repeat the same process with the Right Armrest(C).

Note: Make sure the Tapered Connectors on Backrest(A) lock into the Tapered Connectors on the Left Armrest(B) and Right Armrest(C).

Assistance from an adult partner is necessary for this assembly process.

During this assembly process - do exercise caution. You may need to use your hand to press down and or pave away the padded surface to facilitate the 'slip and slide' assembly.

Caution: Ensure that your fingers do not get caught or pinched in the assembly process.

Step 7

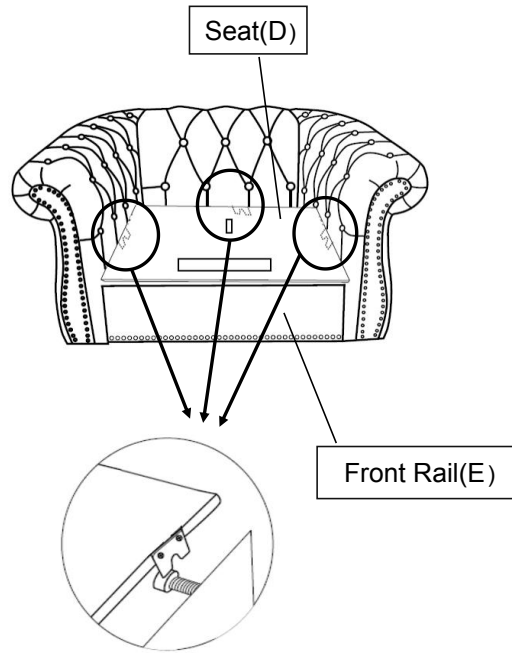

With the assistance of your partner, lift the rope on the two sides of Seat(D) by hand. Put the Seat(D) on the wood bar of the Front Rail(E) and then slowly place it down as shown above.
Note: All the u-shaped iron sheet need clamped to the bolt.

Step 8

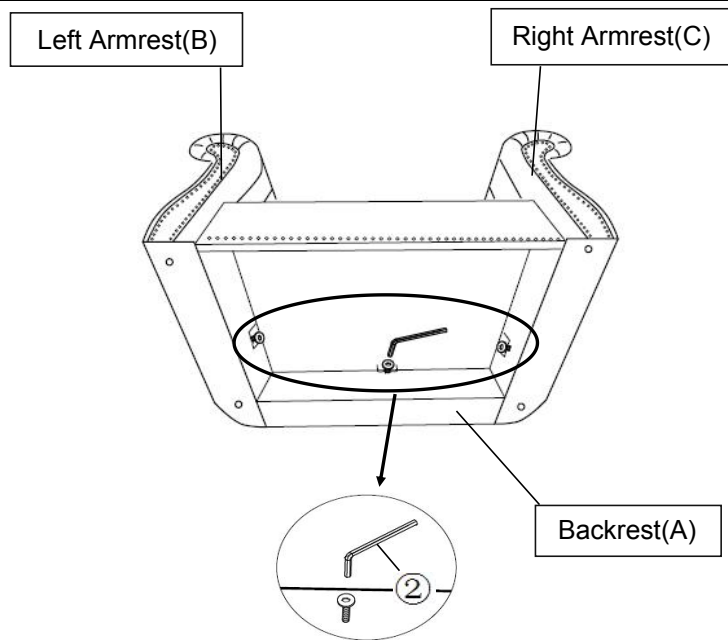

Tilt and lay the Chair onto a flat surface.
Tighten the Bolts in the bottom of Backrest(A), Left Armrest(B) and Right Armrest(C) by Allen Wrench(②) as pictured above.
Tighten the Bolts fully in a sequential manner.

Step 9

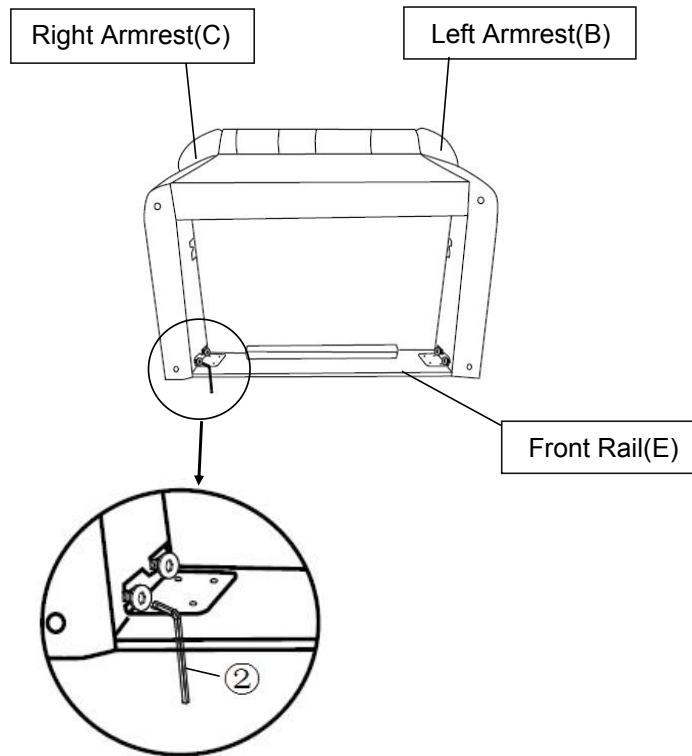

Change tilt and lay the Chair another side onto a flat surface.
Tighten all the Bolts at the end of bottom Left Armrest(B) and Right Armrest(C) by Allen Wrench(②) as pictured above.
Tighten the Bolts fully in a sequential manner.

Step 10

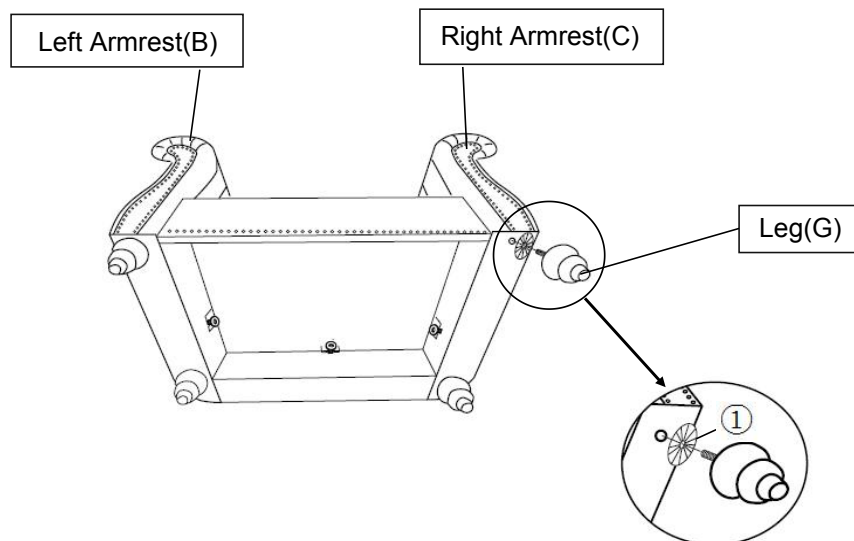

Install the Leg(G) at the bottom of Left Armrest (B) and Right Armrest(C) by placing Plastic Washer(①) on the threaded stem.
Then insert threaded stem into the threaded mounting position at the bottom of Left Armrest(B) and Right Armrest(C). Tighten by turning the Leg clockwise.
Note: The use of Plastic Washer(①) are OPTIONAL and are especially useful to help alleviate slight wobbles. Some Legs may need more than one whilst some legs may not need any.

Step 11

Seat Cushion(F)

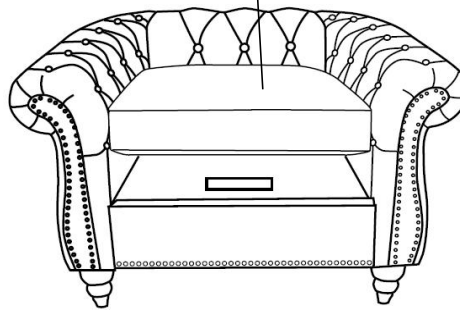





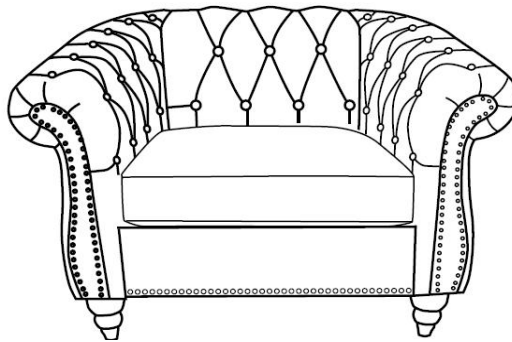





Turn the Chair to its upright position.
Place the Seat Cushions(F) onto the Chair.

Step 12



Your Chair is ready for use.
This Chair can only be used on a flat, level surface.

Care & Maintenance

- ✓  ● Furniture may scratch floors. We recommend using furniture pads to protect your floors.
- ⊘  ● Do not put hot items directly on furniture surface.
- ⊘  ● Do not clean furniture with harsh cleansers or polish.
- ⊘  ● Do not place furniture under direct sunlight.
- ⊘  ● Do not place furniture near heating or cooling vents.
- ⊘  ● Do not write on furniture without a padded barrier to protect the surface.
- ⊘  ● Do not place furniture outside . For indoor use only.
- ⊘  ● Not for commercial use. For residential use only.
- ⊘  ● Stains may be removed with mild soap solution and damp cloth.
- ⊘  ● Children should not climb or jump on the furniture.
- ✓  ● Dust and pick-up spills using a clean, non-colored, lint-free cloth.