

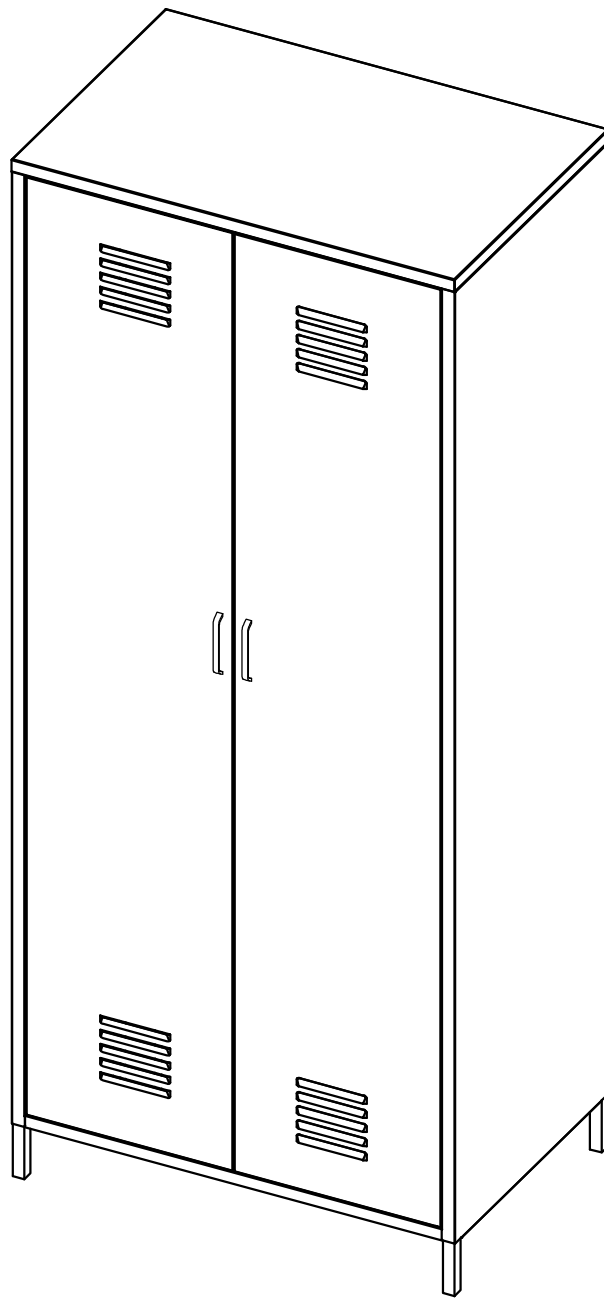





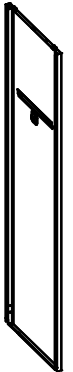

# ASSEMBLY INSTRUCTION

<Before assembling, read all the instruction>

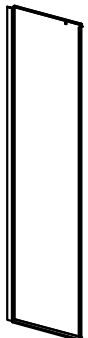
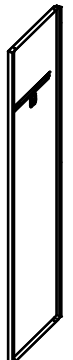
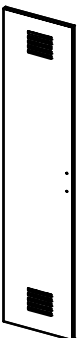
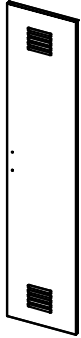
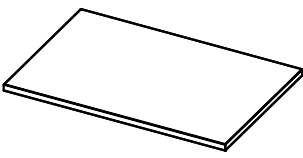
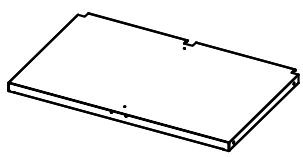
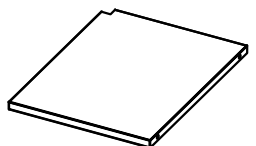
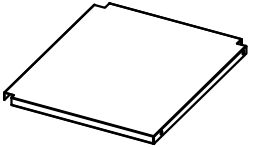
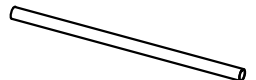
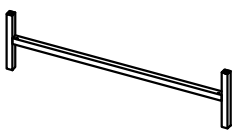

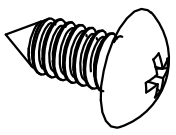
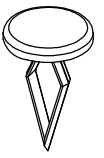
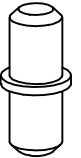
|  |   |  |  |
|--|---|--|--|
| <p>1</p>  <p>1pc</p>    | <p>2</p>  <p>1pc</p>     | <p>3</p>  <p>1pc</p>               | <p>4</p>  <p>1pc</p>    |
| <p>5</p>  <p>1pc</p>    | <p>6</p>  <p>1pc</p>     | <p>7</p>  <p>1pc</p>               | <p>8</p>  <p>1pc</p>    |
| <p>9</p>  <p>1pc</p>   | <p>10</p>  <p>3pcs</p> | <p>11</p>  <p>1pc</p>            | <p>12</p>  <p>1pc</p> |
| <p>13</p>  <p>1pc</p> | <p>14</p>  <p>1pc</p>  | <p>A</p>  <p>M5X12<br/>17pcs</p> | <p>B</p>  <p>4pcs</p> |
| <p>C</p>  <p>2pcs</p> | <p>D</p>  <p>2pcs</p>  | <p>E</p>  <p>2pcs</p>            | <p>F</p>  <p>2pcs</p> |

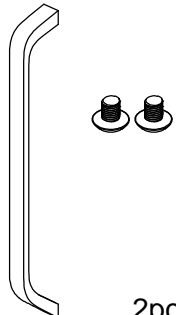
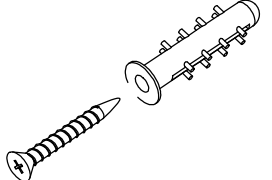
1

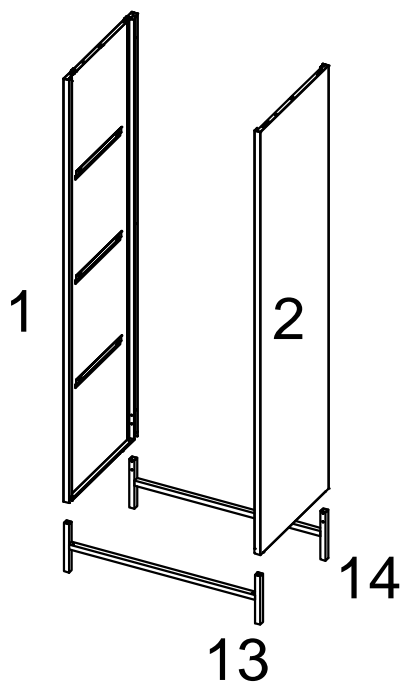

3

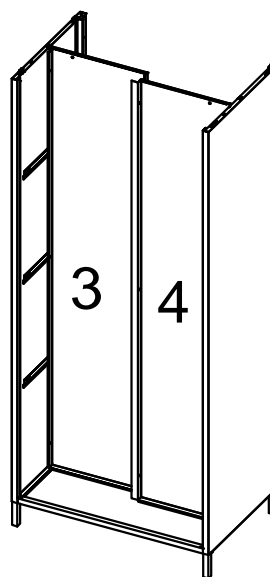

2

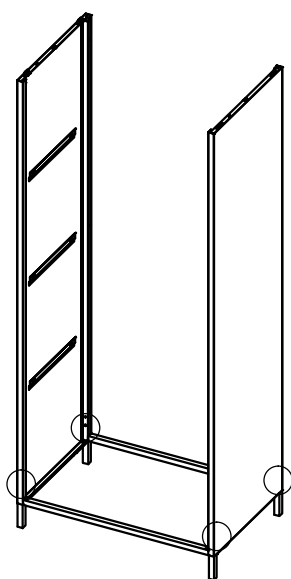

4pcs



4

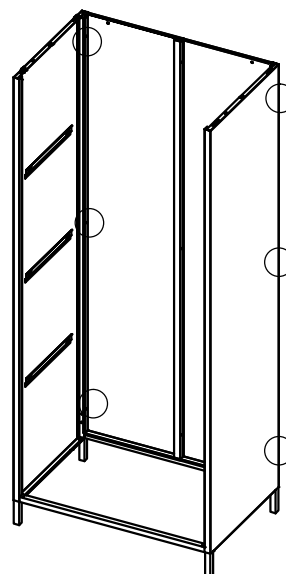

M5X12  
6pcs



5

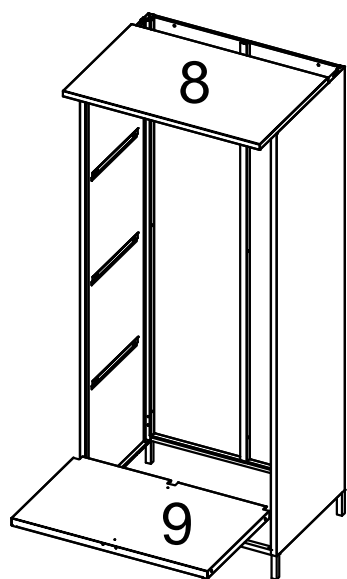

7

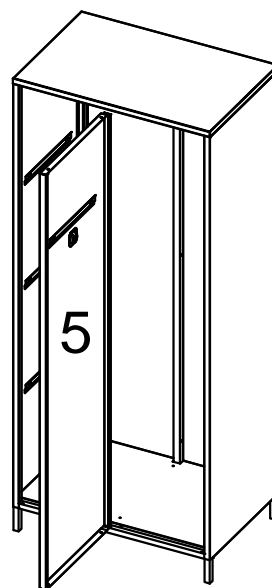

6

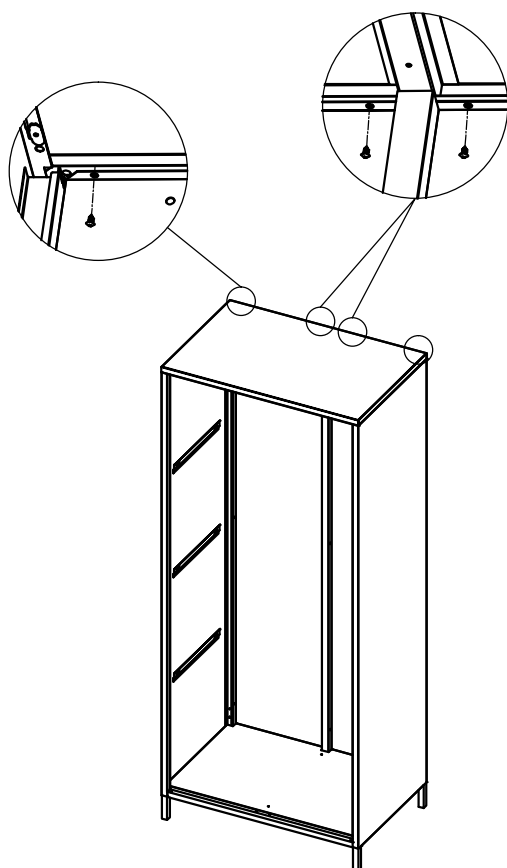

M5X12  
4pcs



8

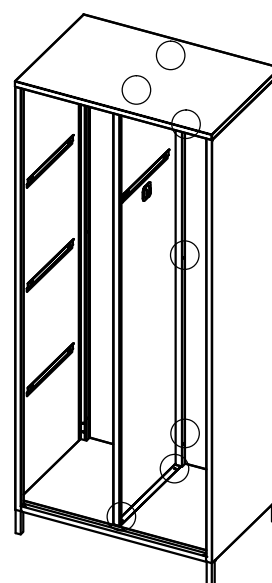

M5X12  
7pcs



9

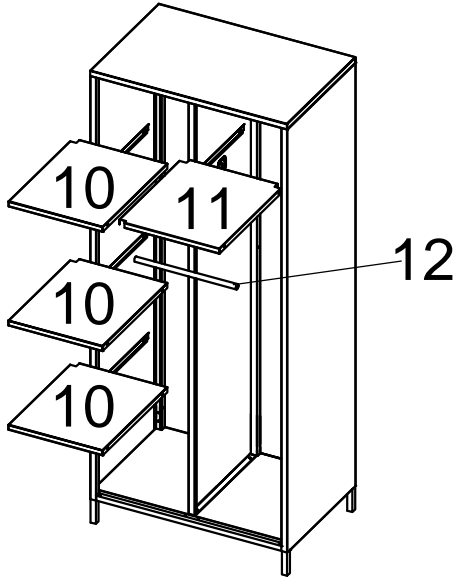

11

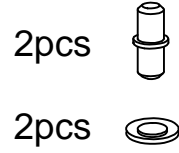
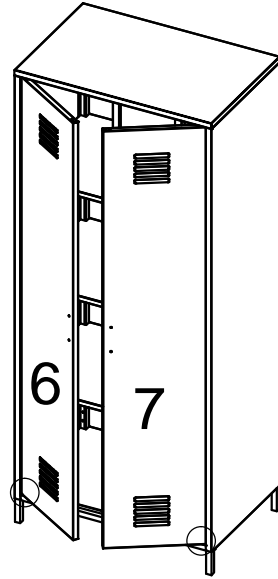

10

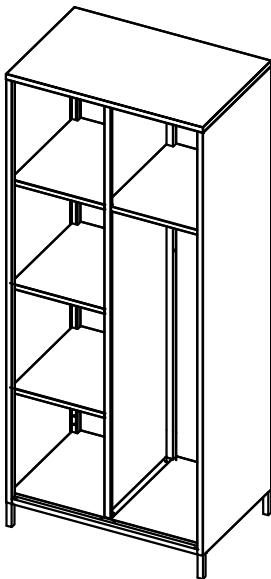

12

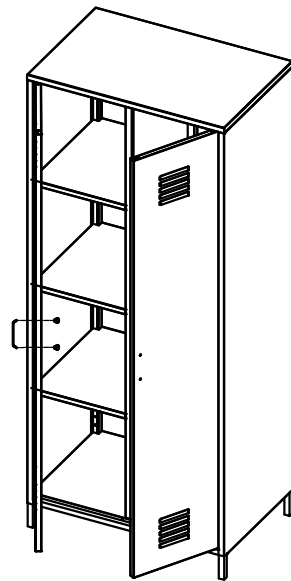

# 13

2pcs

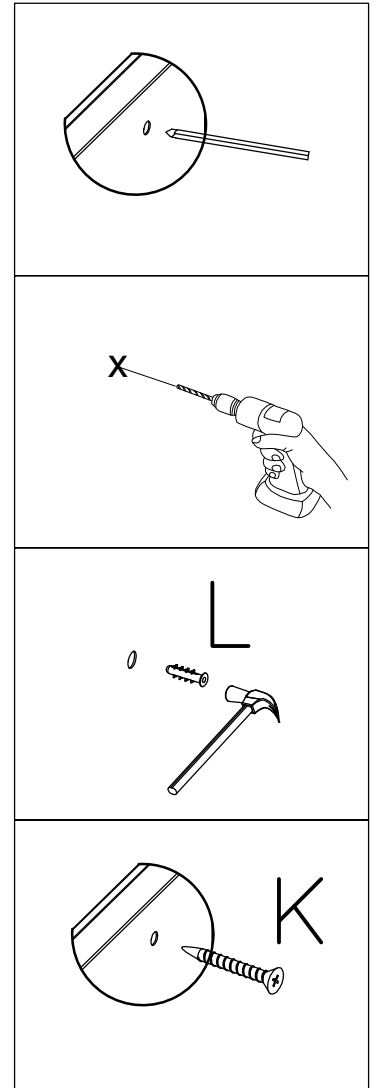
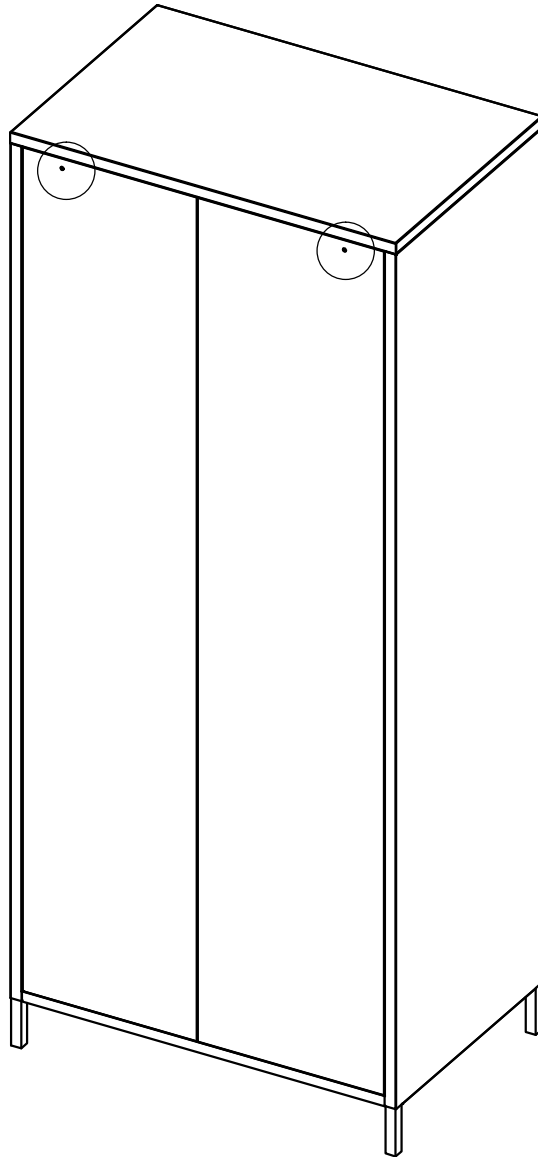
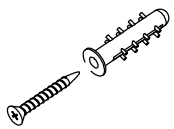

## SAFETY NOTICE

### PREVENT FURNITURE TIP OVER ACCIDENTS

- Free Standing Furniture above 600mm in height must be securely attached to the wall to prevent it from tipping over and causing injury.
- Restraints when installed properly could provide protection against the unexpected tipping of furniture due to use.
- Ensure the anti-tipping hardware is suitable for the material your wall is constructed of.
- If in doubt consult a qualified trades person.
- Always place the heaviest items in the lowest sections.
- Do not place heavy objects on top of this item.
- Never allow children to climb or hang on the cabinet.