

OA-36

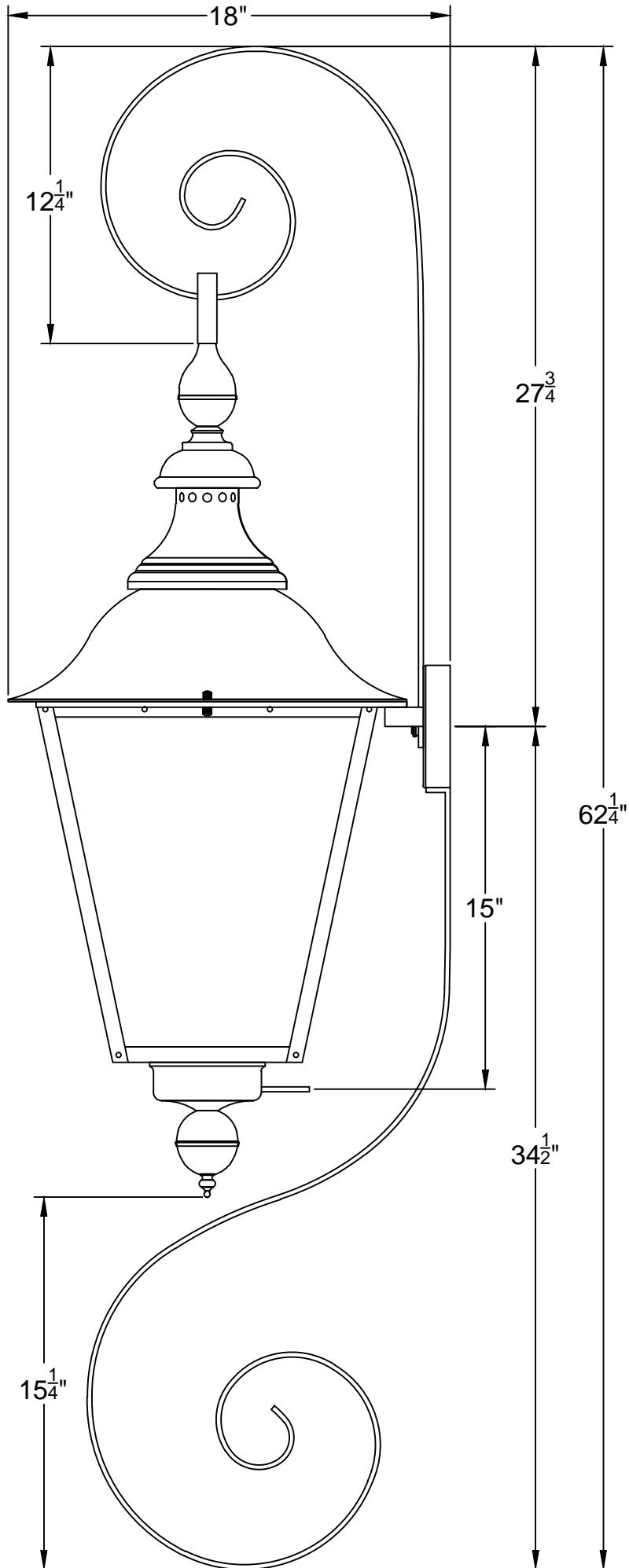

TS-4 BS-3