













ASSEMBLY INSTRUCTION

FOR HEADBOARD/FOOTBOARD

(BOX 1)
BOX OF HEADBOARD & FOOTBOARD

ITEM	DRAWING	DESCRIPTION	Q'TY
A		HEADBOARD PANEL	1
B		LEFT HEADBOARD LEG	1
C		RIGHT HEADBOARD LEG	1
D		FOOTBOARD PANEL	1
E		LEFT FOOTBOARD LEG	1
F		RIGHT FOOTBOARD LEG	1

(BOX 1)
HARDWARE LIST FOR STEP1 & STEP2

ITEM	DRAWING	DESCRIPTION	Q'TY
1		BOLT	12
2		SPRING WASHER	12
3		FLAT WASHER	12
4		WOOD PLUG	4
5		ALLEN KEY	1
6		WOOD DOWEL	8

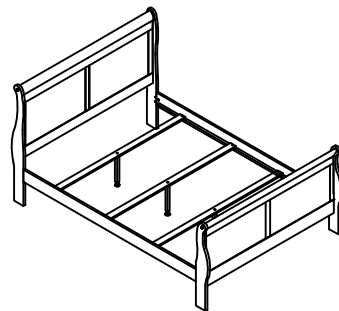

**COMPLETED QUEEN BED
ASSEMBLY**

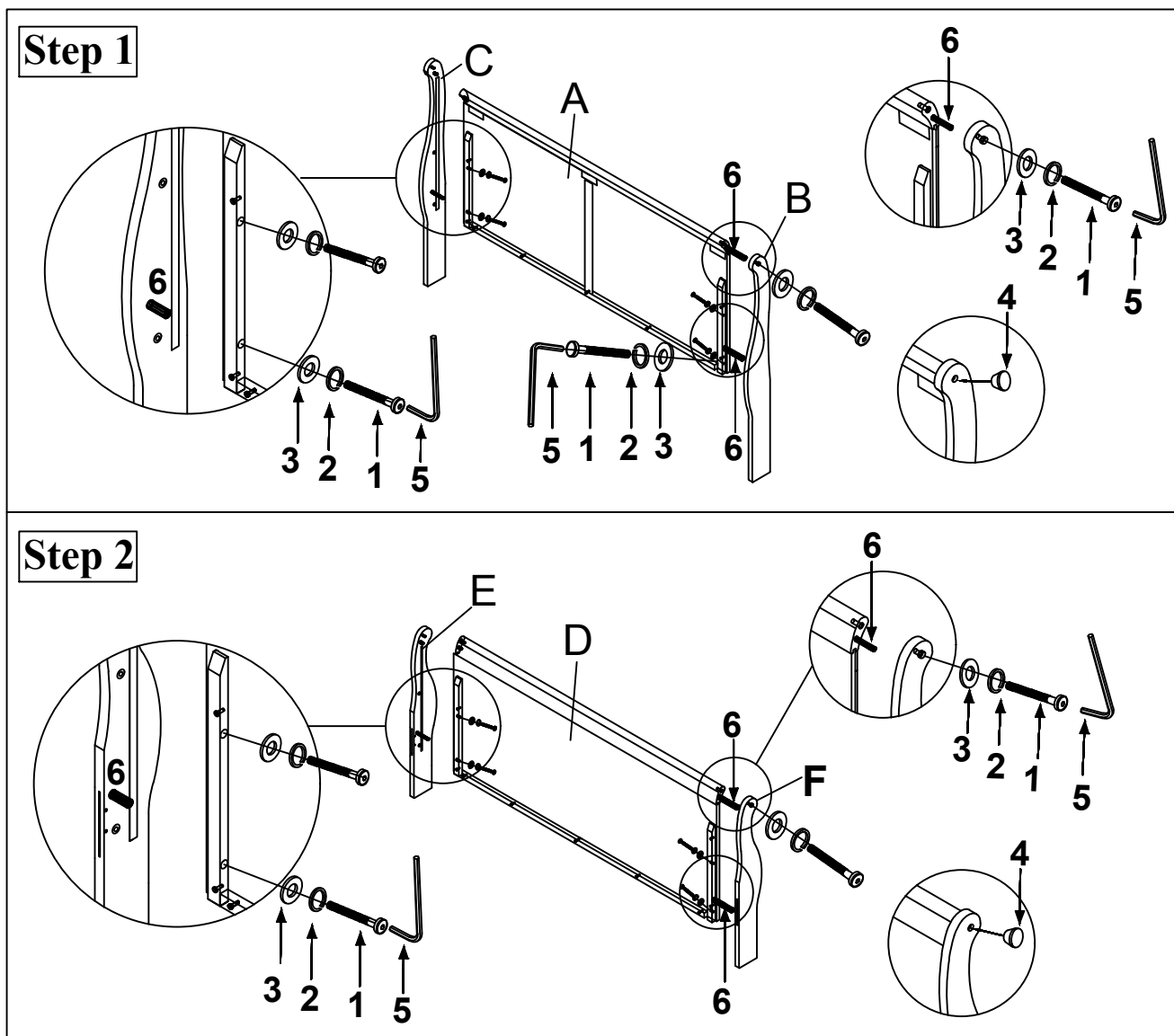

THE HARDWARE IS LOCATED IN THE PACKING ITEMS

NOTE: MUST TIGHTEN SCREWS PERIODICALLY WITH USE SCREWS MAY BECOME LOOSE.

CHECK TIGHTNESS OF ALL SCREWS EVERY 6-8 WEEKS.

CLEANING INSTRUCTION

After assembled, clean & polish the completed parts if necessary with soft cloth and industrial recognized furniture polish.

MADE IN VIETNAM