

Uper Twin Bed

This set is included 3 boxex if do not receive full 3 boxex please contact our customer service team

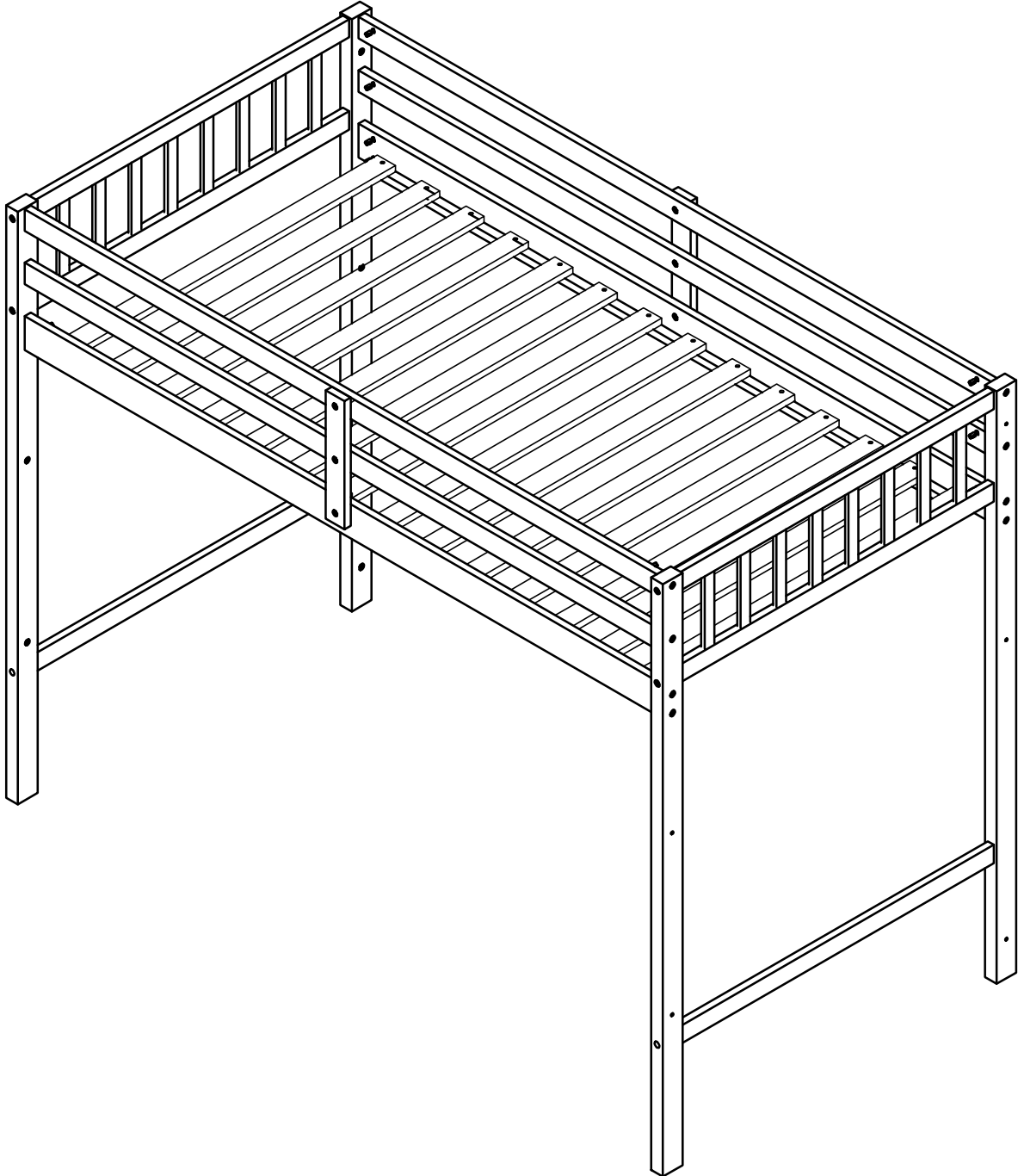

PART LIST

1

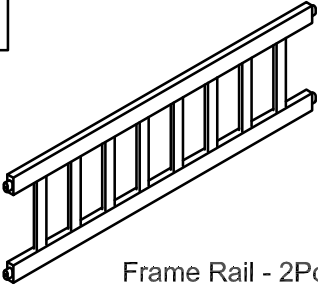





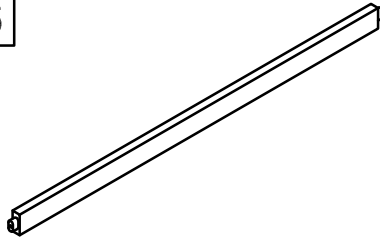

Frame Rail - 2Pcs

6

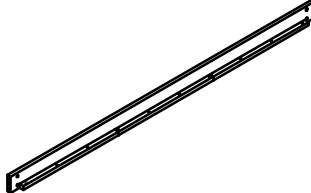

Support Rail (L&R) - 2pc

PART LIST

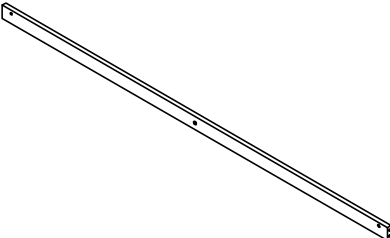
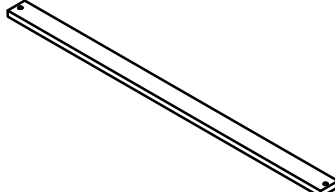
<p>2</p>  <p>Legs headboard (L) - 1pc</p>	<p>3</p>  <p>Legs headboard (R) - 1pc</p>	<p>4</p>  <p>Legs footboard (L) - 1pc</p>
<p>5</p>  <p>Legs footboard (R) - 1pc</p>	<p>7</p>  <p>Side rails - 2Pcs</p>	<p>8</p>  <p>Vertical guardrail-2pcs</p>
<p>9</p>  <p>Long guardrail (Back)-4pcs</p>	<p>10</p>  <p>Slats-14pcs</p>	

HARDWARE LIST

A

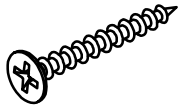

M4x30
Wood screws-28pcs

B

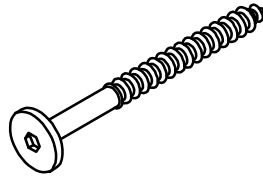

$\text{\O}1/4 \times 70 \text{ mm}$
Hexagonal bolts catch Wood-12Pcs

C



$\text{\O}1/4 \times 80 \text{ mm}$
Hex-Head bolts - 16Pcs

D



$\text{\O}10 \times 40\text{mm}$
Dowles - 12Pcs

E



$\text{\O}1/4 \times 13\text{mm}$
Cross nuts - 16Pcs

F

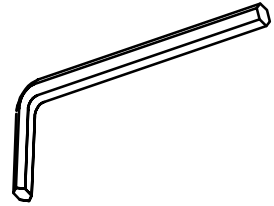

Allen Key - 1Pc

G



$\text{\O}1/4" \times 25 \text{ mm}$
Hex-Head bolts - 6pcs

H



$\text{\O}1/4" \times 15 \text{ mm}$
Canopy head though - 6pcs

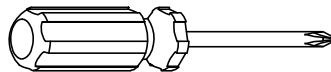

Assembly Tools Required (Not Included)

**PLEASE BE CAREFUL DO NOT DAMAGE THE HOLE
POSITION WHEN YOU USE POWER TOOLS!**

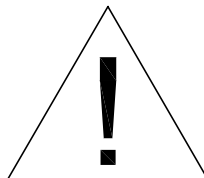

STEP 1

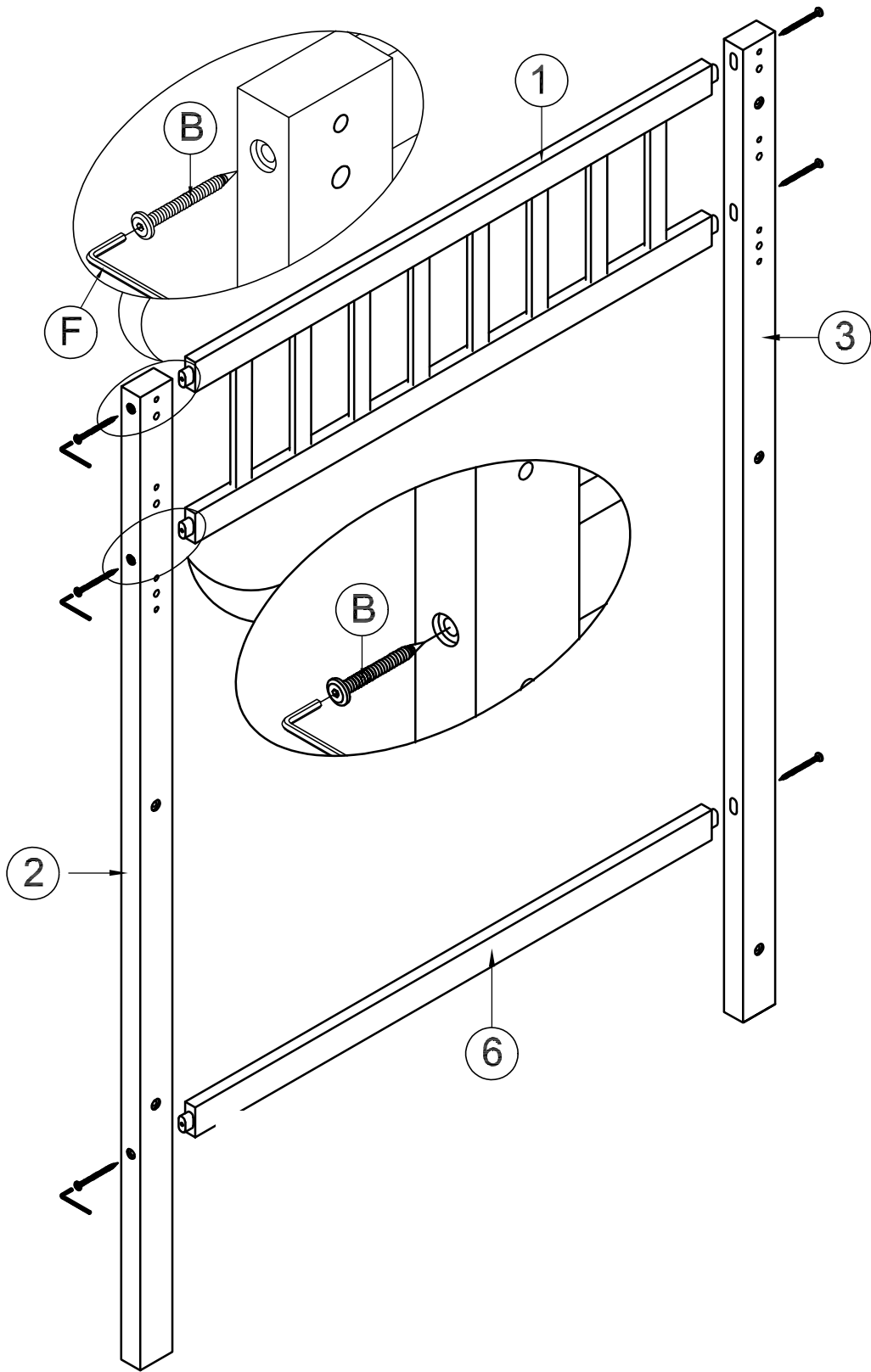
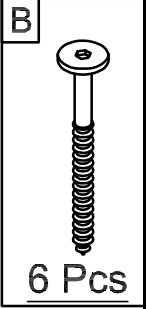



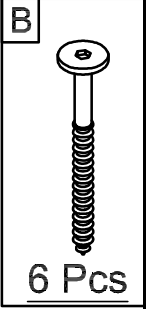
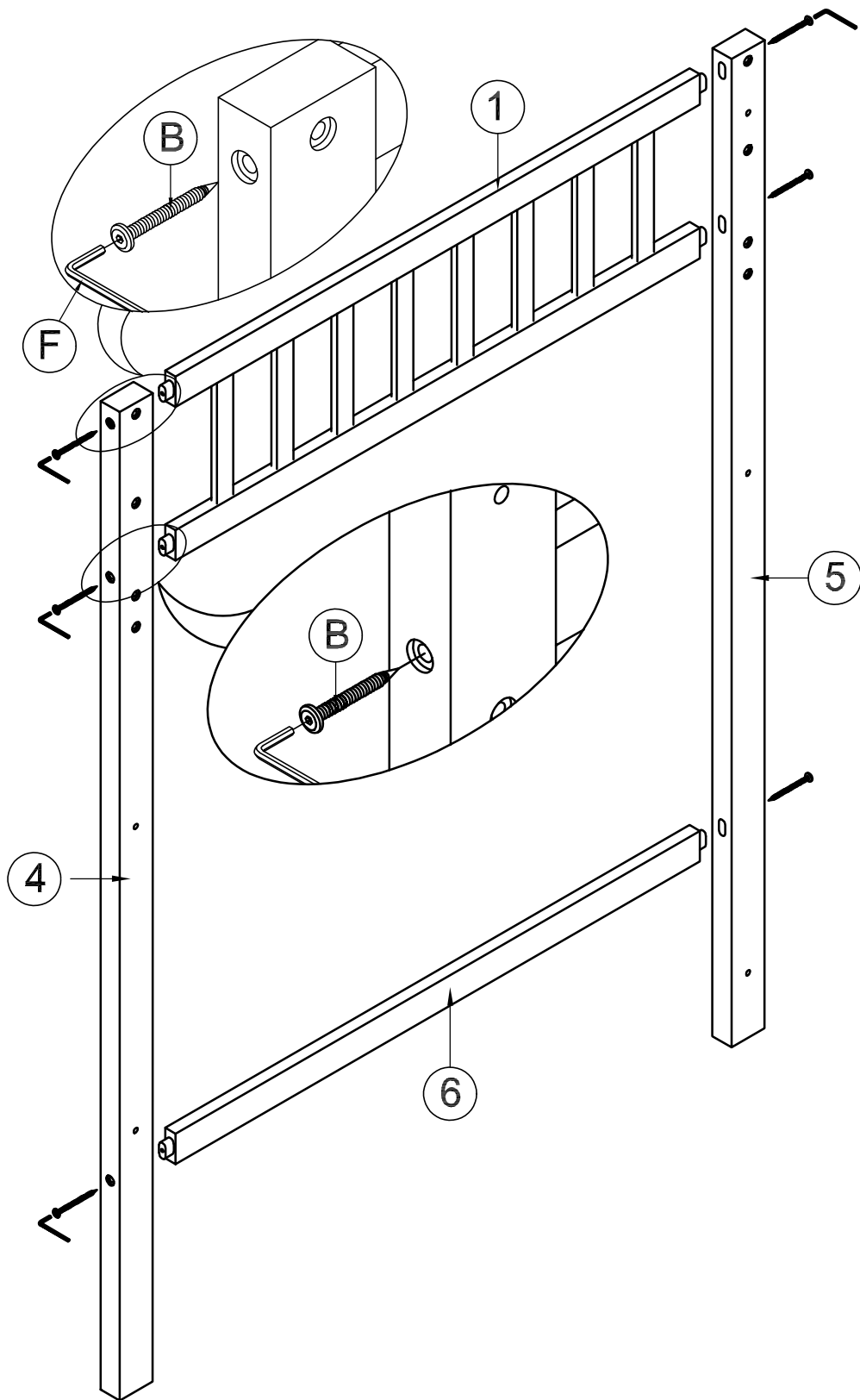

HEADBOARD

STEP 2



FOOTBOARD

STEP 3

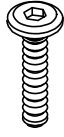
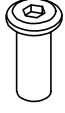
F  1pcs	C  16pcs	E  16pcs	D  12pcs
		G  6pcs	H  6pcs

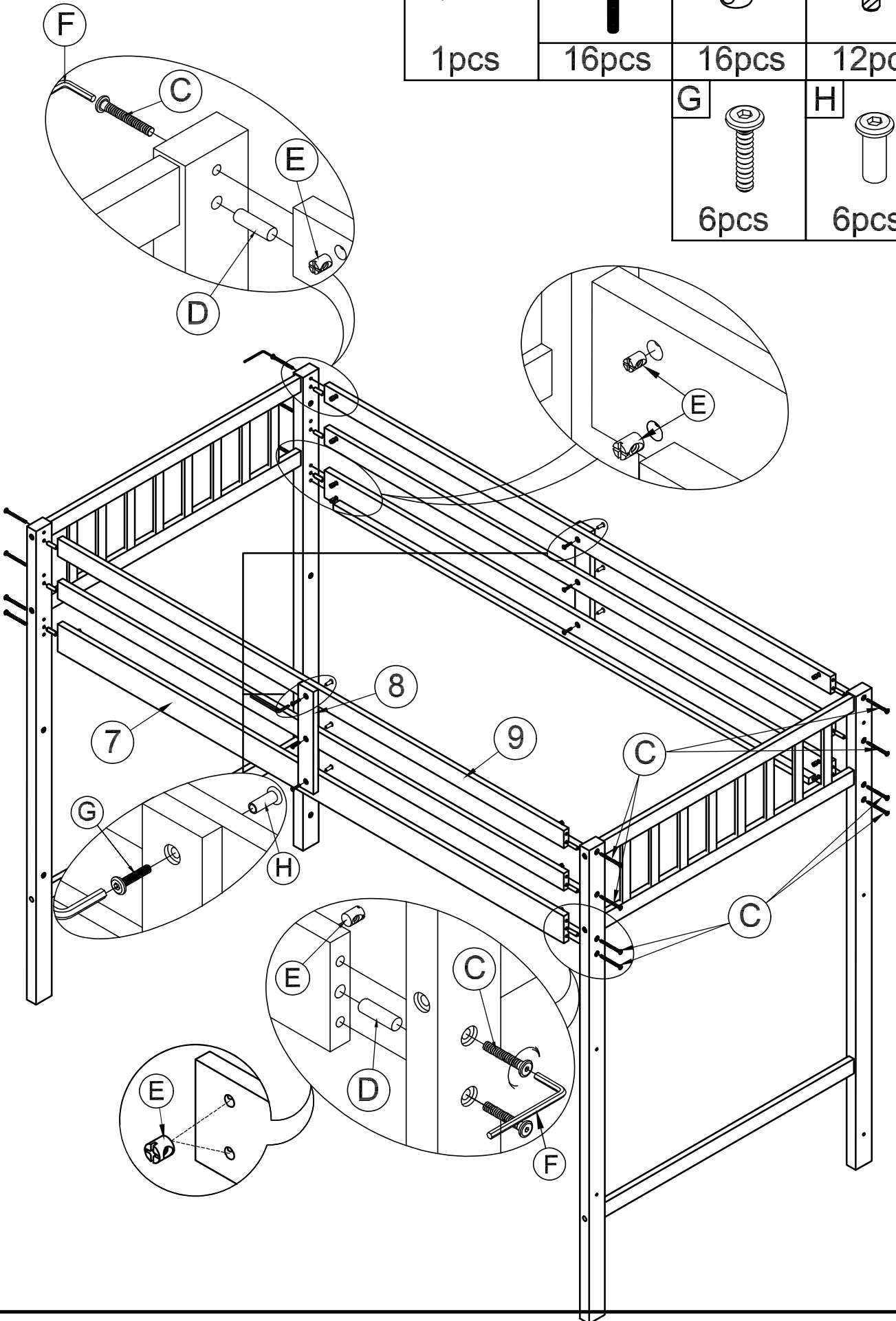

STEP 4

A

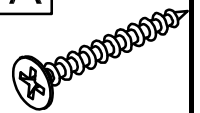

28 pcs

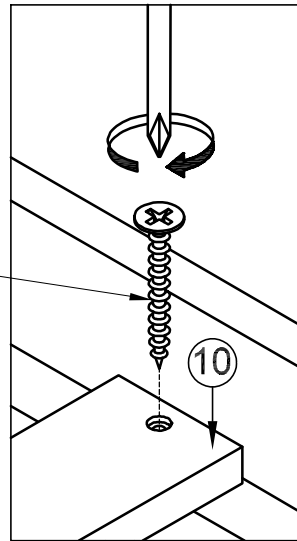

Please complete screw all slats to siderail before out the mattress on and using