

ASSEMBLY INSTRUCTIONS



BOOKCASE

ASSEMBLY INSTRUCTIONS

ASSEMBLY TIPS:

1. Remove hardware from box and sort by size.
2. Please check to see that all hardware and parts are present prior to start of assembly.
3. Please follow attached instructions in the same sequence as numbered to assure fast & easy assembly.



WARNING!









1. Don't attempt to repair or modify parts that are broken or defective. Please contact the store immediately.
2. This product is for home use only and not intended for commercial establishments.

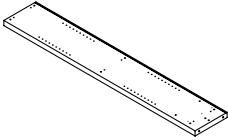
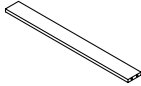
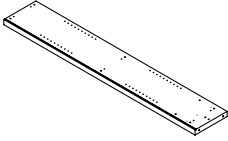
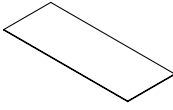

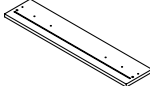
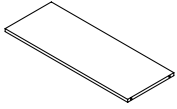
ASSEMBLY TIME

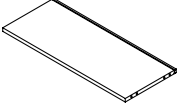
50 MINUTES

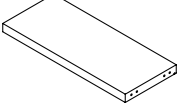
PARTS IDENTIFICATION

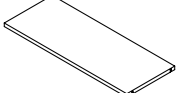
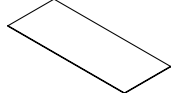







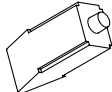

A	LEFT SIDE PANEL		1 PC	H	CROSS BRACE		1 PC
B	RIGHT SIDE PANEL		1 PC	I	BACK PANEL		6 PCS
C	BOTTOM PANEL		1 PC	J	DRAWER FRONT PANEL		1 PC
D	LOWER SHELF		1 PC	K	DRAWER BACK PANEL		1 PC
E	UPPER SHELF		1 PC	L	LEFT DRAWER SIDE PANEL		1 PC
F	TOP PANEL		1 PC	M	RIGHT DRAWER SIDE PANEL		1 PC
G	ADJUSTABLE SHELF		2 PCS	N	DRAWER BOTTOM PANEL		1 PC

NOTE:

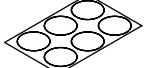
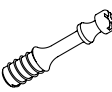
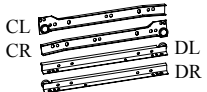
Phillips head screw driver is required in the assembly process; however, manufacturer does not provide this item.

Z

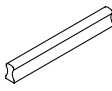
HARDWARE IDENTIFICATION

NO	DESCRIPTION	FIGURE	Q'TY	NO	DESCRIPTION	FIGURE	Q'TY
1	GLUE 40g		1 PC	9	CAM BOLT Ø6x21mm SR		8 PCS
2	WOODEN DOWEL Ø8x30mm		22 PCS	10	PLASTIC FEET M8x16mm		4 PCS
3	CAM LOCK Ø15x12mm SR		14 PCS	11	STICKER Ø20mm		3 PCS
4	CAM BOLT Ø7x35.5mm SR		14 PCS	12	RAIL L = 250mm WHT		1 SET
5	SCREW Ø4.3x35mm SR		4 PCS	13	FIXER		6 PCS
6	SCREW Ø3x10mm SR		10 PCS	14	SCREW Ø3x19mm SR		6 PCS
7	HANDLE L = 120mm		2 PCS	15	PLASTIC BACK BRACE		4 PCS
8	BOLT Ø4x28mm SR		4 PCS				

Z7,Z8,Z10,Z12,Z15 not included in blister packaging.

NOTE:

Phillips head screw driver is required in the assembly process; however, manufacturer does not provide this item.

STEP 3

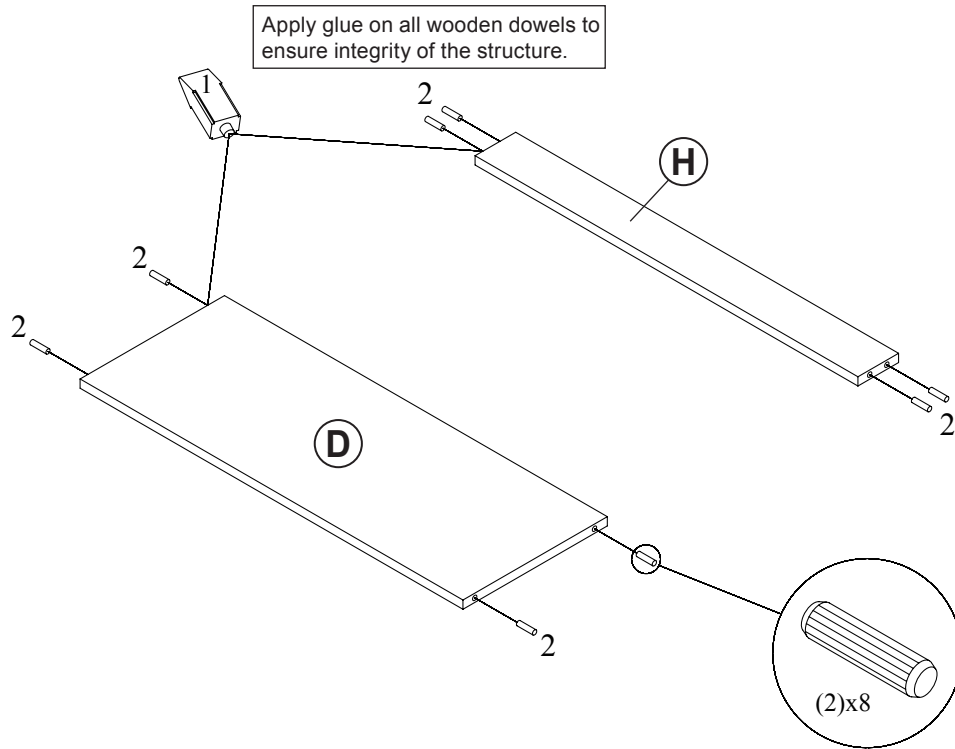

STEP 4

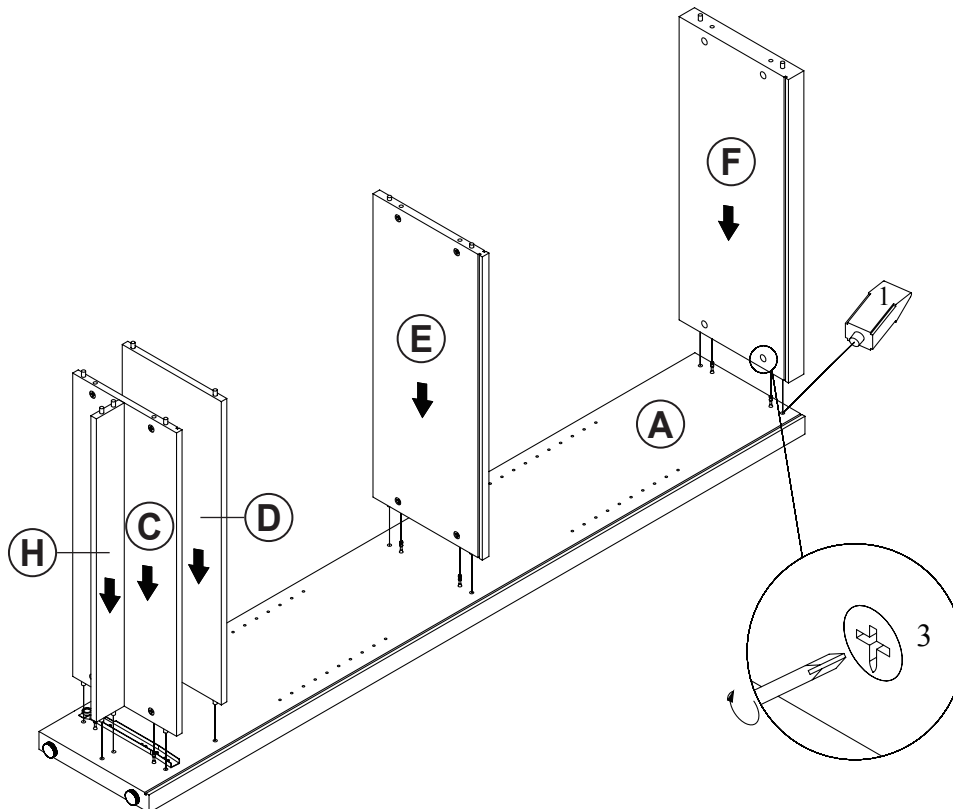

STEP 5

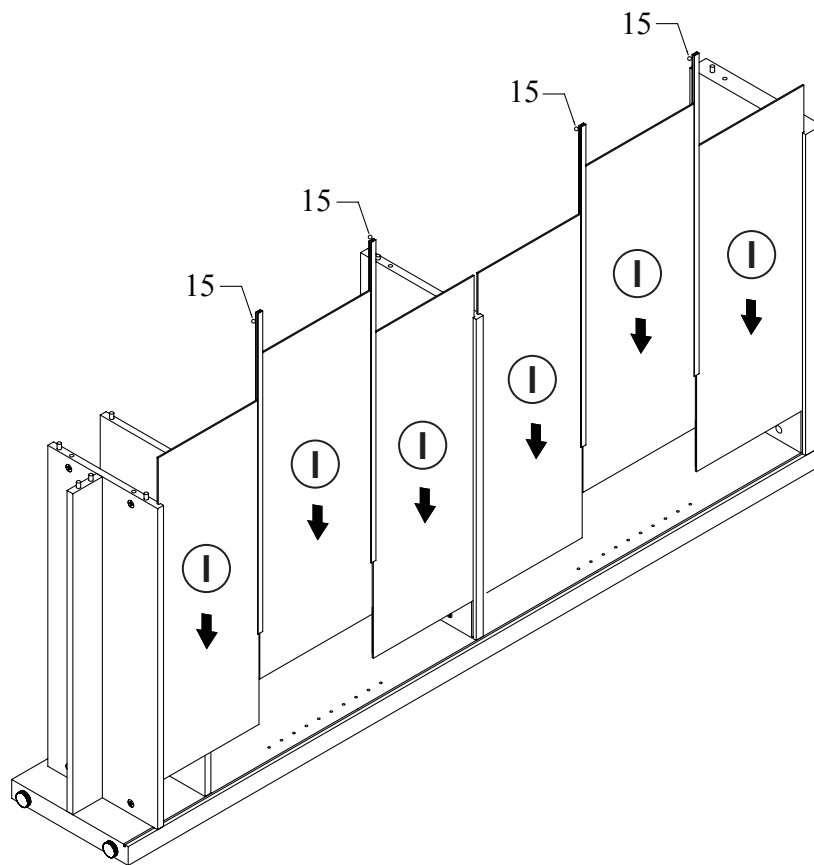

STEP 6

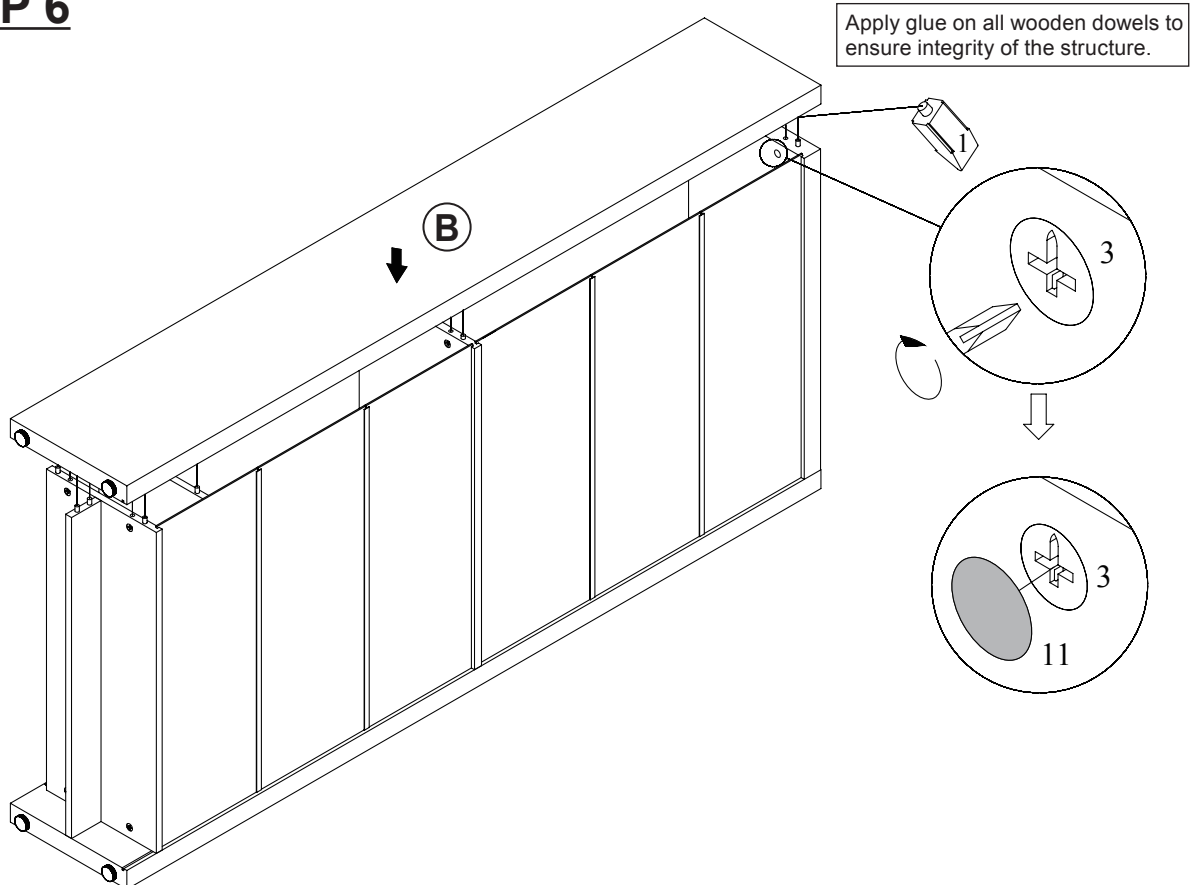

STEP 7

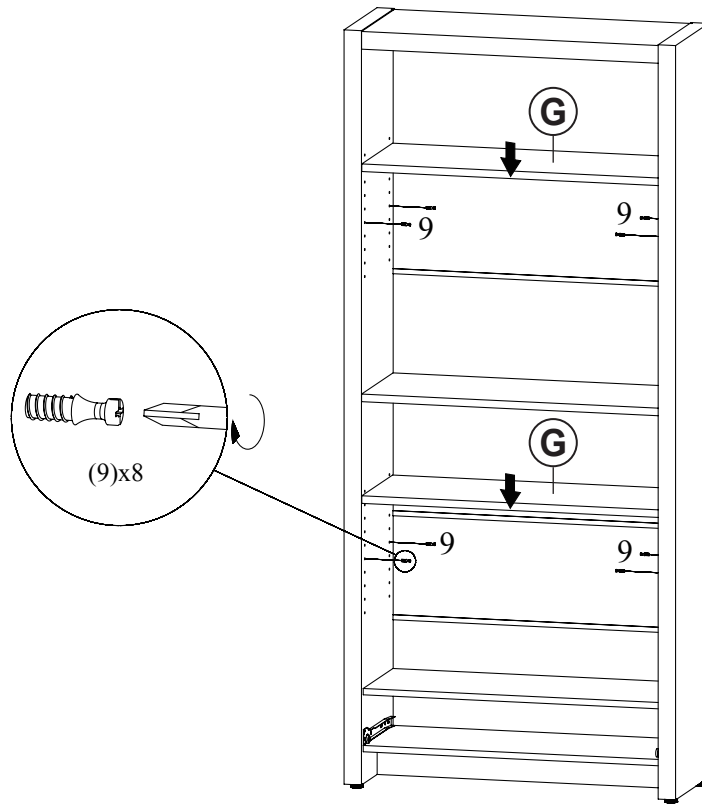

STEP 8

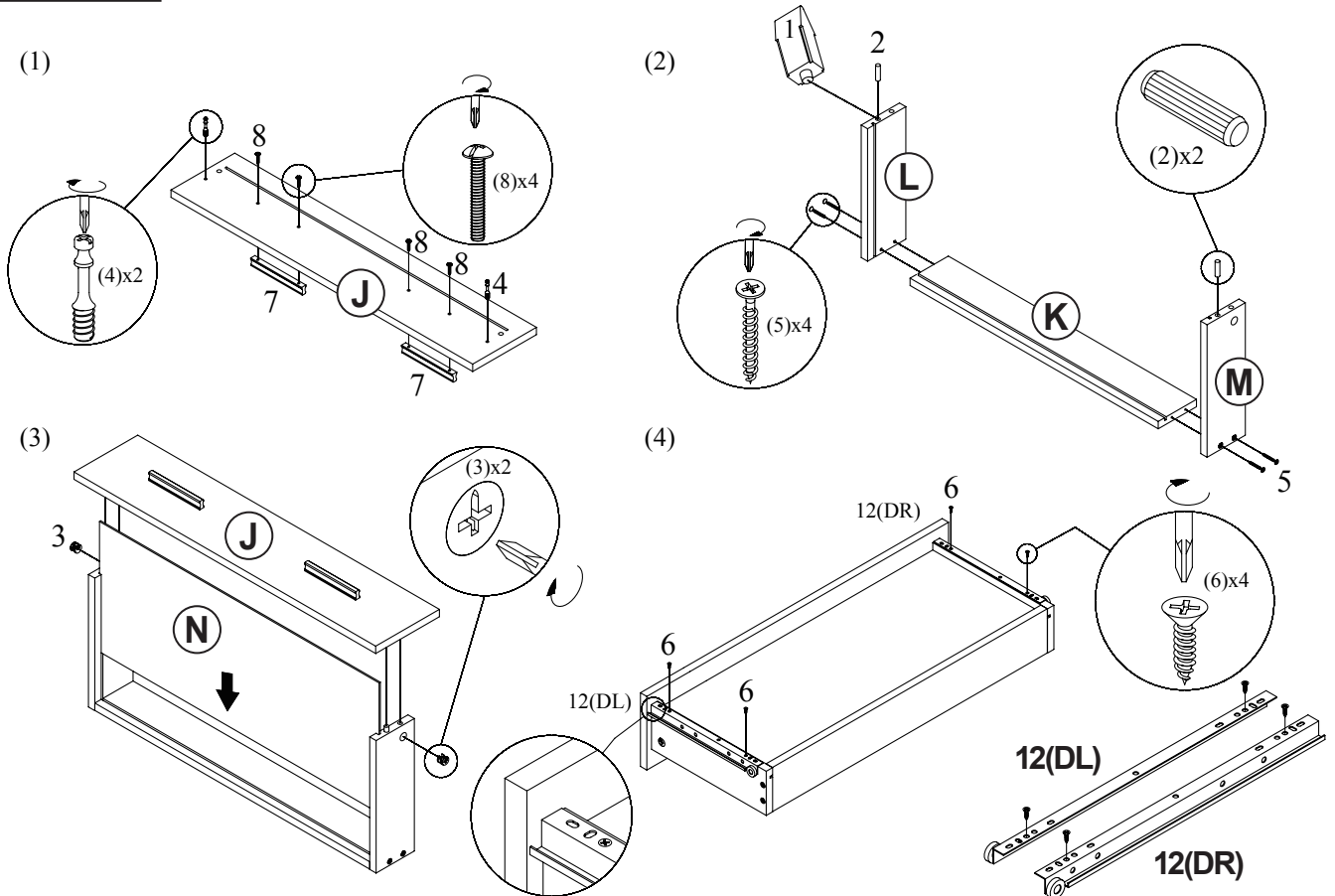

STEP 9

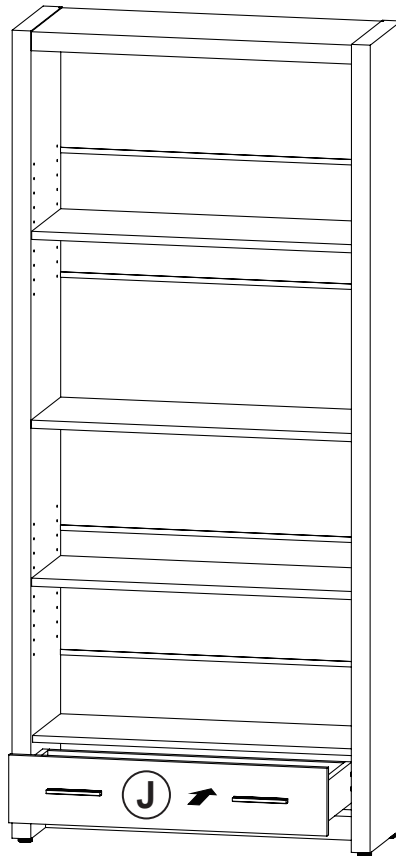

STEP 10

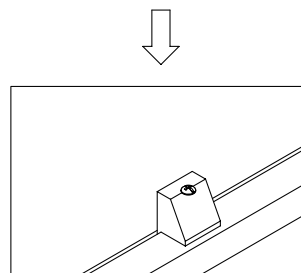
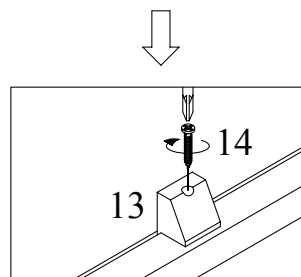
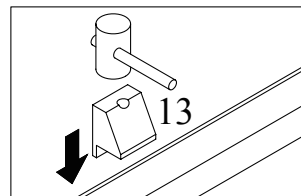
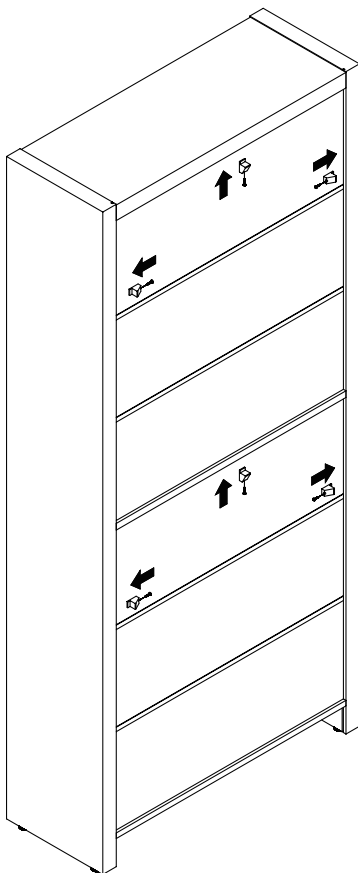

COMPLETE

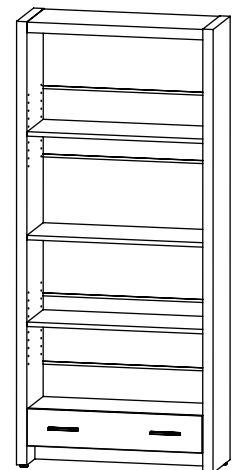

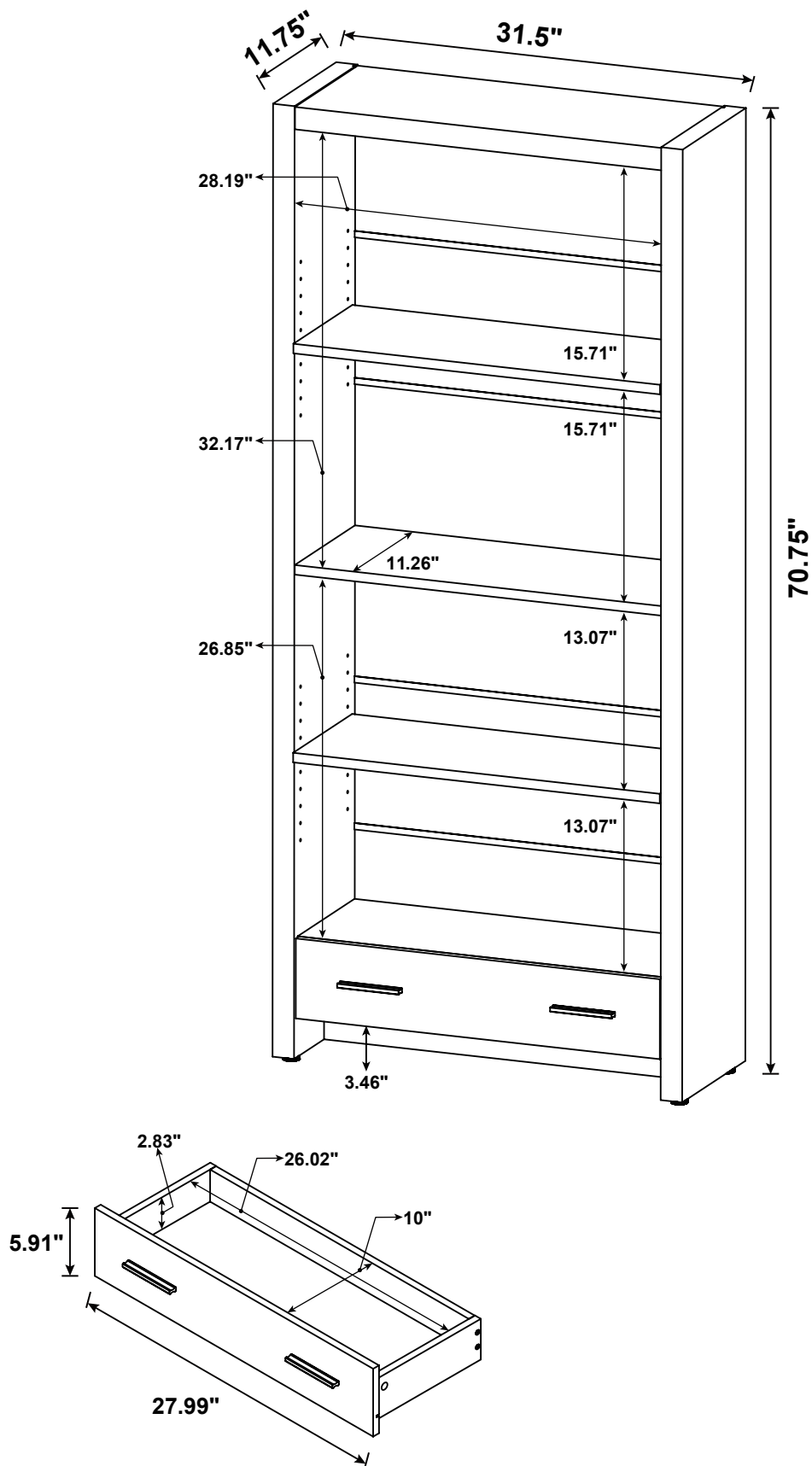

Note : Dimension tolerance $\pm 5\%$

ANTI-TIPPING INSTALLMENT INSTRUCTIONS

FURNITURE TIPPING RESTRAINT

WARNING

Injury may result from tipping furniture.
This restraint may protect against tipping furniture.
Do not allow children to climb on furniture.
This restraint is not a substitute for proper adult supervision.
Failure to detach this restraint before moving the furniture
may result in injury and damage.

1. To attach the anti-tip strap, securely mount one end to the top of the case piece with the 5/8" screw.
2. Position the case piece against the wall in the desired location.
3. Pull the anti-tip strap taut and mark the position of where you will secure the other end on the wall.
4. Drill a 1-1/4" hole in the spot you marked.
5. Tap in plastic wall plug.
6. Fasten anti-tip strap with wall screw provided.

(Please install the anti-tipping kit in the middle of the case piece if only have one set of anti-tipping kit.)

