

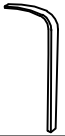

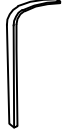



CHAIR

DO THIS TWO TIMES

A		Left Arm Rest	1PC
B		Rigt Arm Rest	1PC
C		Seat Back	1PC
D		Seat Base	1PC
E	 M6*60	M6*60 Screw	2PCS
F	 M6*15	M6*15 Screw	10PCS
G	 M6	Washer	12PCS
H		Allen Key	1PC

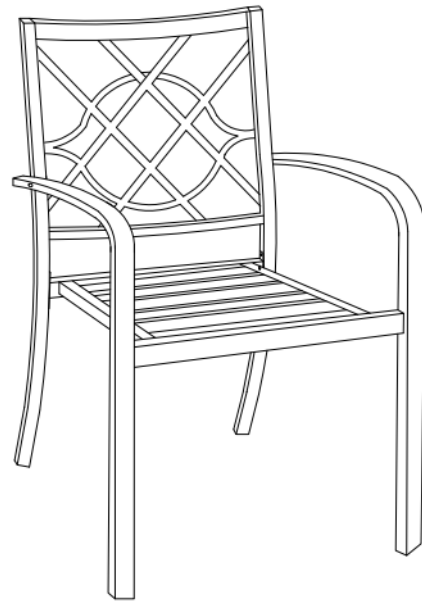

- ① Attach right arm rest (B) to seat base (D) using M6*15 screw (F) and washer (G) as shown.
Attach left arm rest (A) to seat base (D) using M6*15 screw (F) and washer (G) as shown.

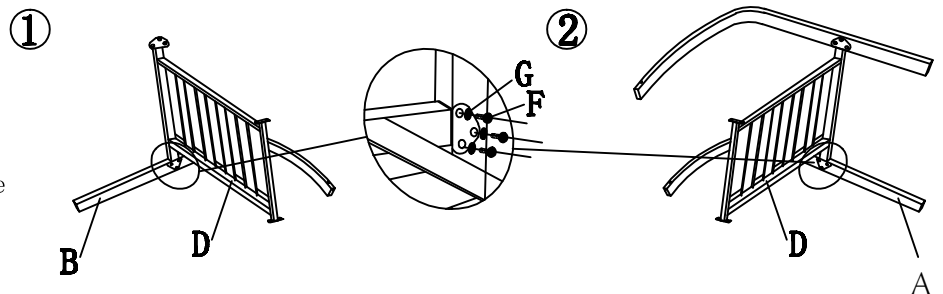

Loose attach all connections at the beginning, adjust alignments then fully tighten all joints

CHAIR

DO THIS TWO TIMES

- ③ Attach seat base (D) to seat back (C) using M6*15 screw (F) and washer (G) as shown.

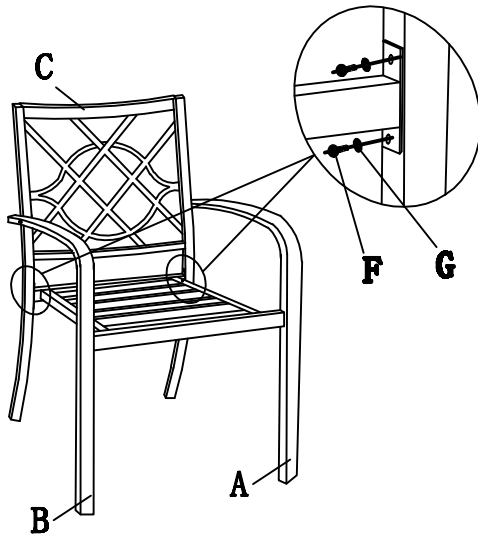

- ④ Attach left arm rest (A) to seat back (C) using M6*15 screw and washer (G) as shown.
Attach right arm rest (B) to seat back (C) using M6*15 screw and washer (G) as shown.

After checking all screw then tighen all screws.

Enjoy your chair!

