

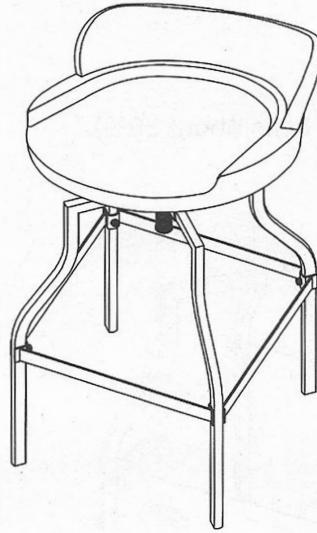





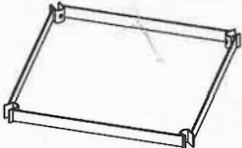

Assembly Instructions

Adjustable Wood Seat Stool

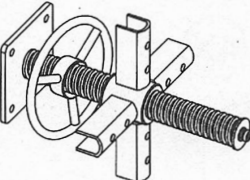

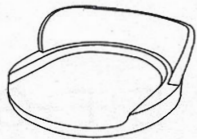
NO.	PART	DESCRIPTION	Q'TY	NO.	PARTS	DESCRIPTION	Q'TY
A		Leg	4PCS	E		Allen Head Bolt 1/4" x 5/8"	16PCS
B		Foot Rest	1PC	F		Spring Washer • 40	16PCS
C		Swivel Shaft	1PC	G		Flat Washer • 42*T1.0	16PCS
D		Seat	1PC	J		Allen Head Wrench 4MM	1PC

Assembly Instructions

Adjustable Wood Seat Stool

STEP 1

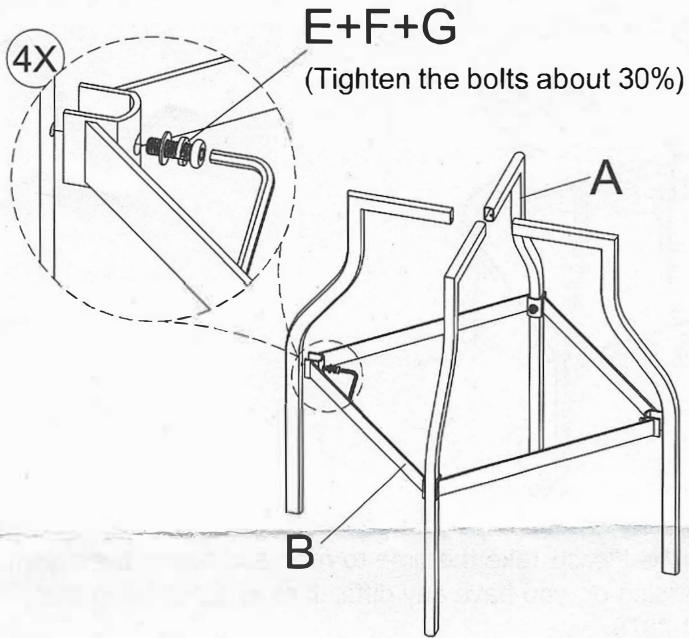

STEP 2

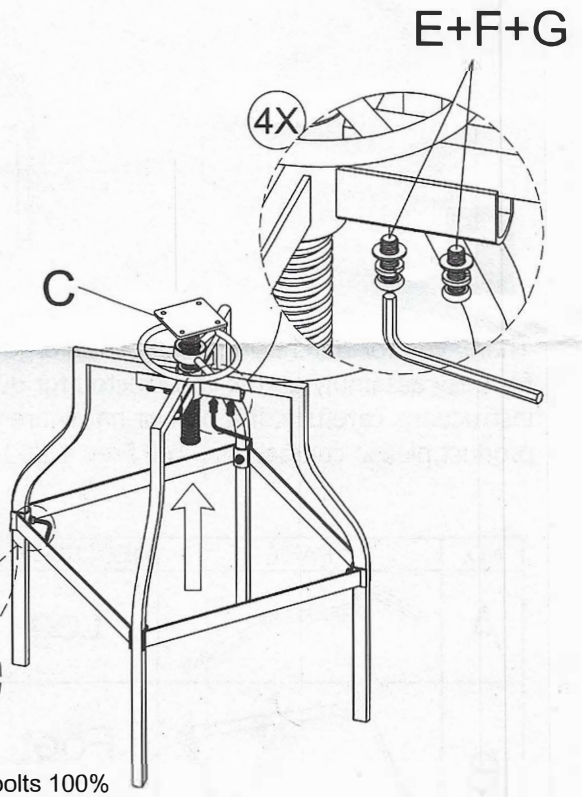

STEP 3

