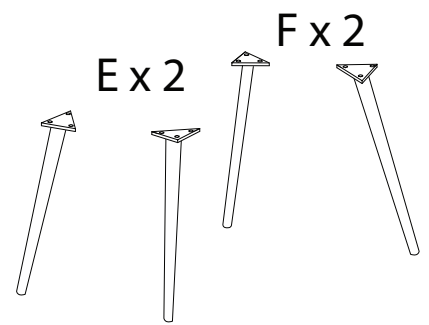
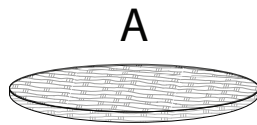
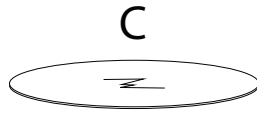
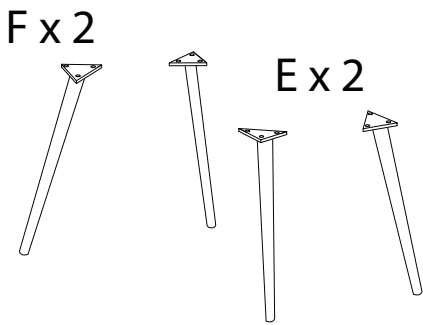
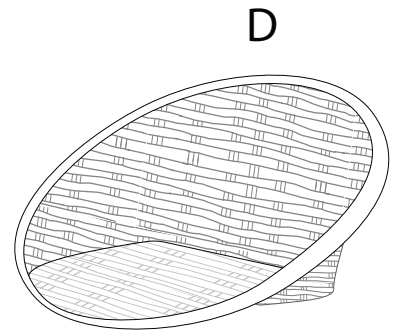
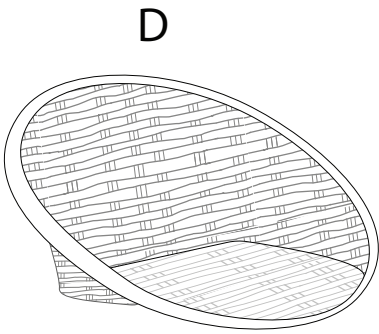
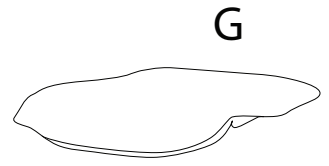
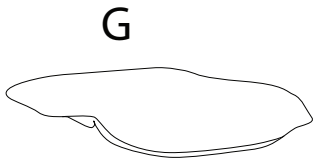
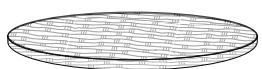

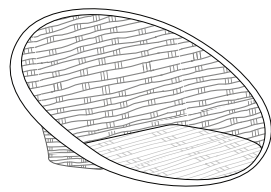



Diagram illustrating assembly instructions and safety warnings:

- Warning 1:** A warning triangle with an exclamation mark is positioned above a box containing an L-shaped metal bracket and a power drill with a slash through it, indicating that a power drill should not be used for this step.
- Warning 2:** A second warning triangle with an exclamation mark is positioned above a box containing a rectangular block being placed on a textured surface and a diagram showing a screw being inserted into the block.
- Time:** A clock icon is shown next to the text "30'", indicating the estimated assembly time.
- Person:** A person icon is shown next to the number "1", indicating that one person is required for assembly.



A	B	C	D
			
x 1	x 4	x 1	x 2

E



x 4

F



x 4

G

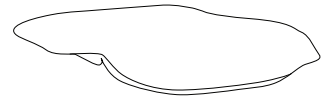

x 2

1

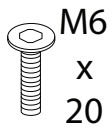

M6
x
20

x 36

2

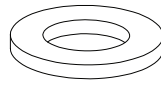

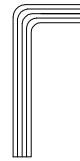

x 36

3

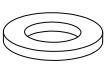
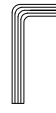
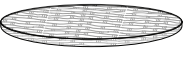

x 1

1



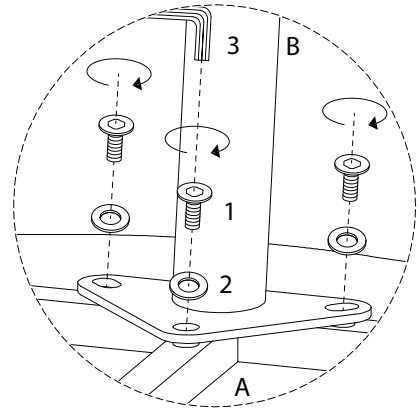
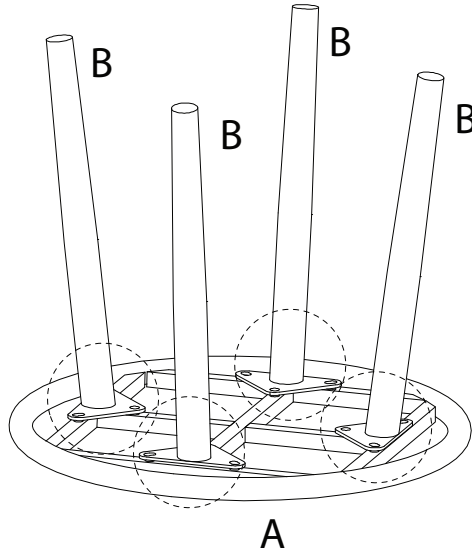

<p>1</p>  <p>M6 x 20</p> <p>x 12</p>	<p>2</p>  <p>x 12</p>	<p>3</p>  <p>x 1</p>	<p>A</p>  <p>x 1</p>	<p>B</p>  <p>x 4</p>
---	--	---	---	---

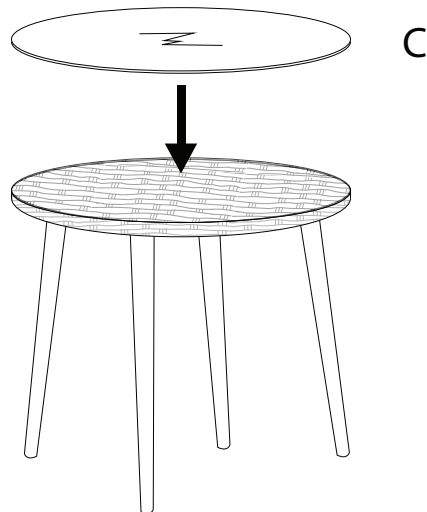
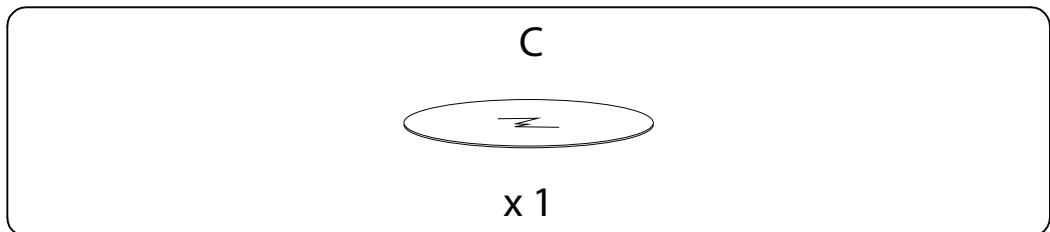

2

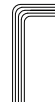
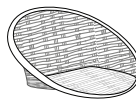

3 x 2

1  M6 x 20 x 12	2  x 12	3  x 1	D  x 1	E  x 2	F  x 2
--	--	---	--	---	---

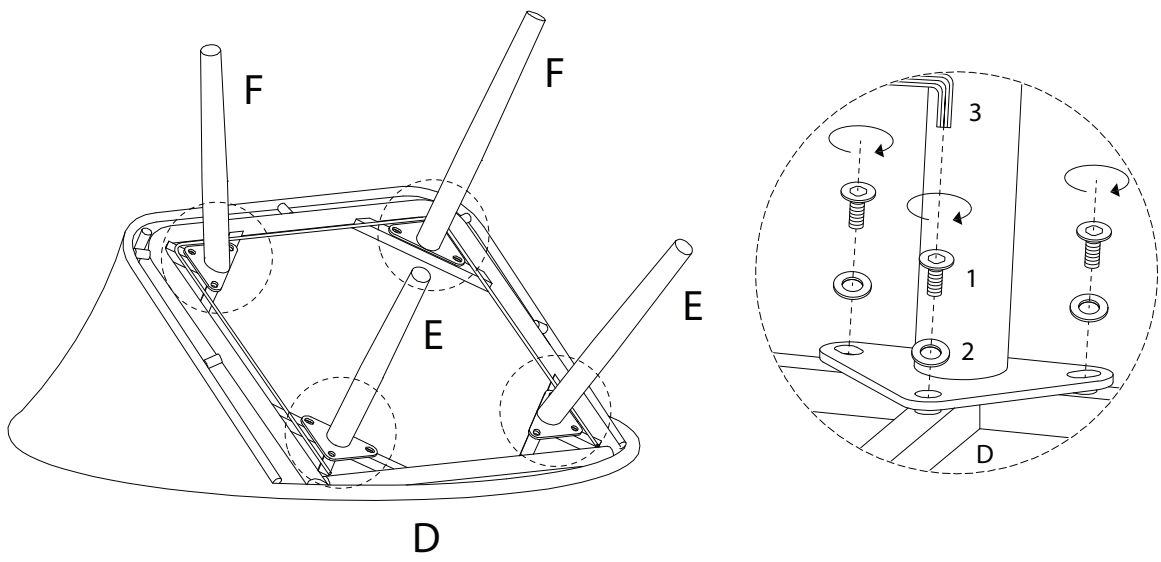

4 x 2

