

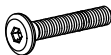



# ASSEMBLY INSTRUCTION FOR

MODEL: 7D DRESSER

1		Bolts M6x35	7
2		Handles	7
3		Allen Key K4	1
4		Tipping Hardware	2

★ **REMARK:** There is a tip restraint kit provided on the back of this product please read the direction thoroughly and install immediately

## Step 1

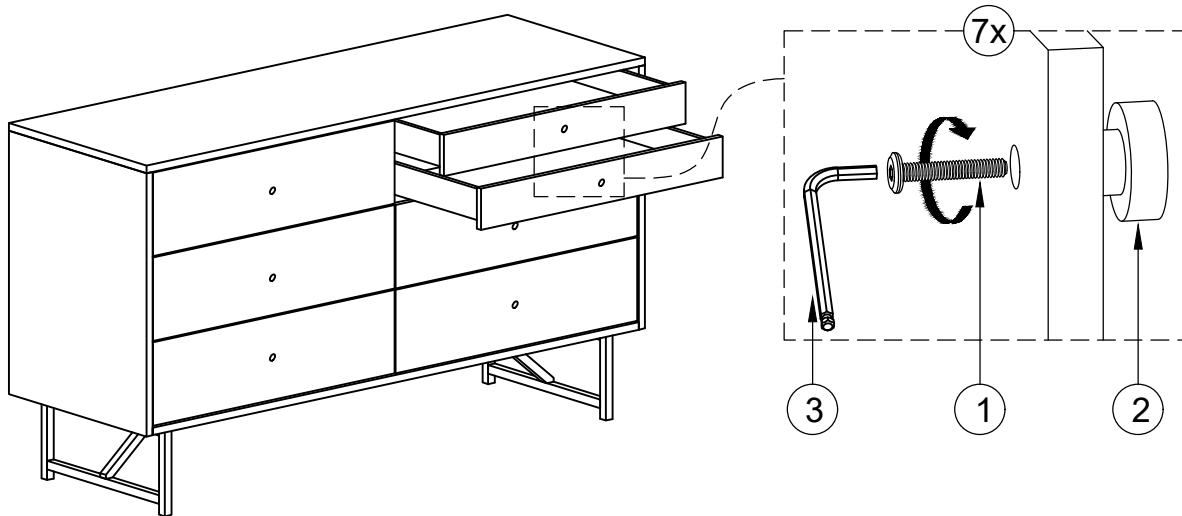

## Step 2

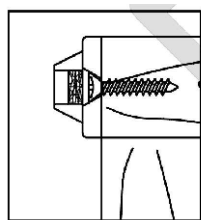

Figure 1

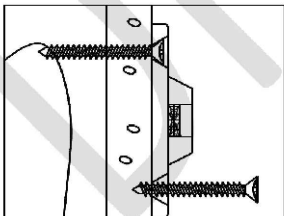

Figure 2

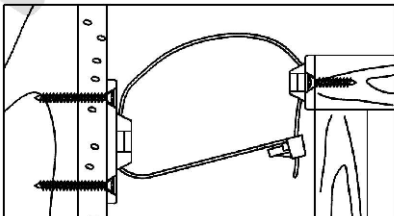

Figure 3

