

Assembly Instruction

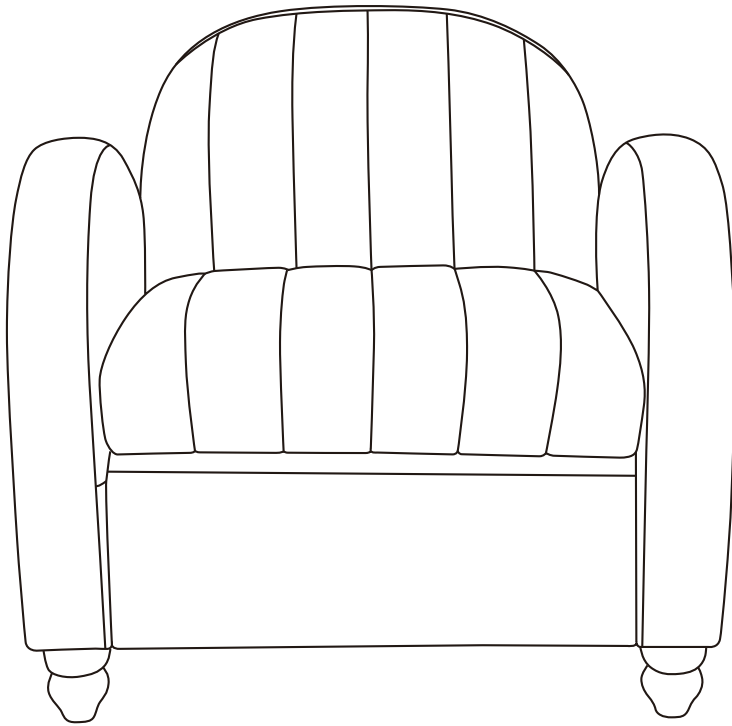

Assembly Instructions

INSTALLATION GUIDE

ONE PERSON ASSEMBLY: 30 MINUTES (APPROXIMATE)

TOOLS REQUIRED: ALLEN WRENCH (PROVIDED)

BEFORE ASSEMBLY

1. Remove all packaging materials, staples and packing straps from the carton.
2. Confirm with Parts Checklist in Page 3.





ATTENTION

1. Leave sufficient space for assembly.
2. Do not assemble on the ground that may hurt the product.
3. Do not over-tighten any fittings as it may cause damage.
4. DO NOT USE POWER TOOLS TO ASSEMBLE THIS PRODUCT.
5. Do not sit or stand on it before the assembly is complete.

DAILY MAINTENANCE

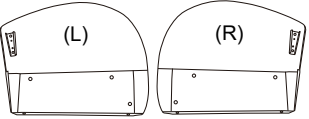
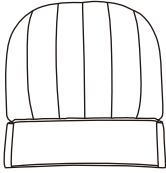
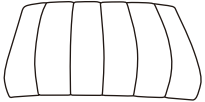
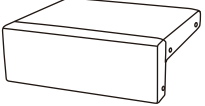
1. Recommended for indoor use only.
2. Wipe with a soft, dry cloth. Keep away from abrasives and household cleaners.
3. Check all the fittings periodically and re-tighten if necessary. Do not use the product if any part is damaged or broken.

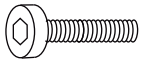
Parts Check List

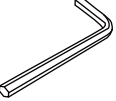
 <p>A x1</p>	 <p>B x1</p>
 <p>C x1</p>	 <p>D x1</p>
 <p>E x4</p>	 <p>F x6</p>
 <p>G x6</p>	 <p>H x1</p>

STEP 1

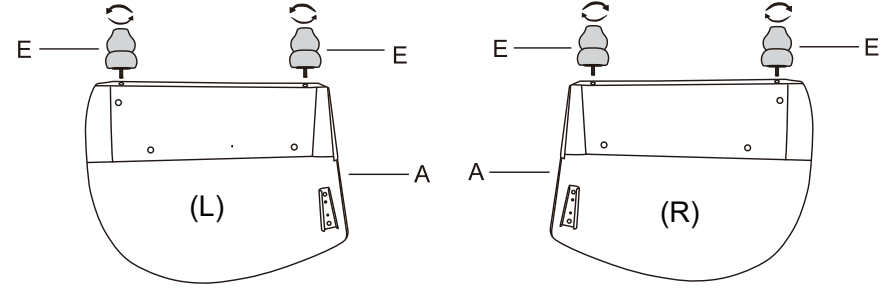

STEP 2

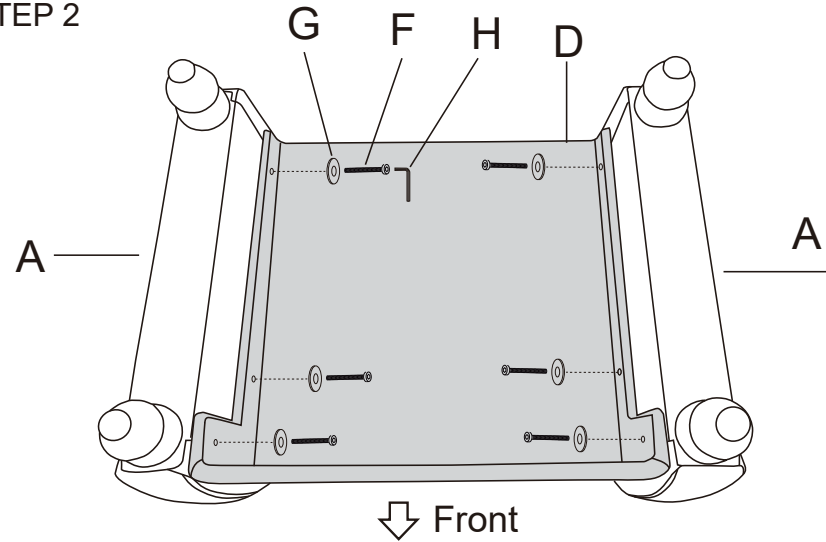

STEP 3

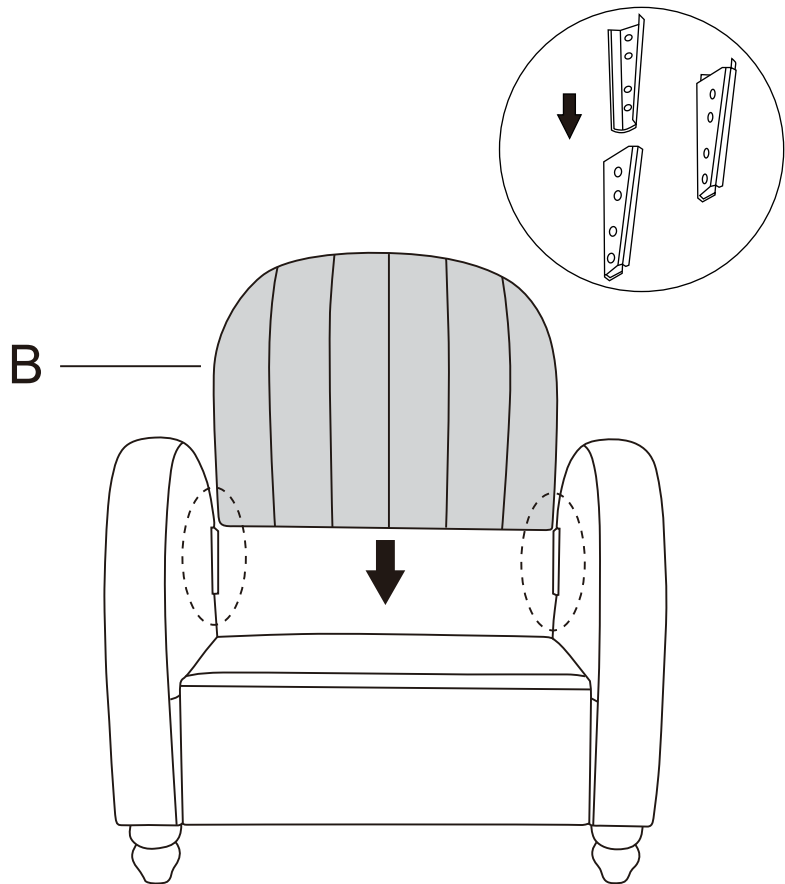

STEP 4

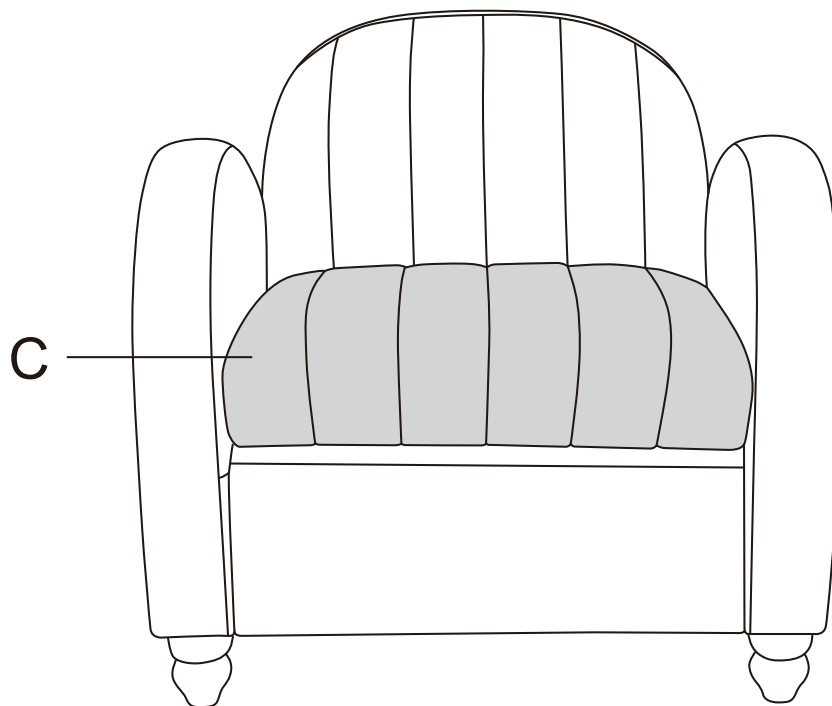

STEP 5

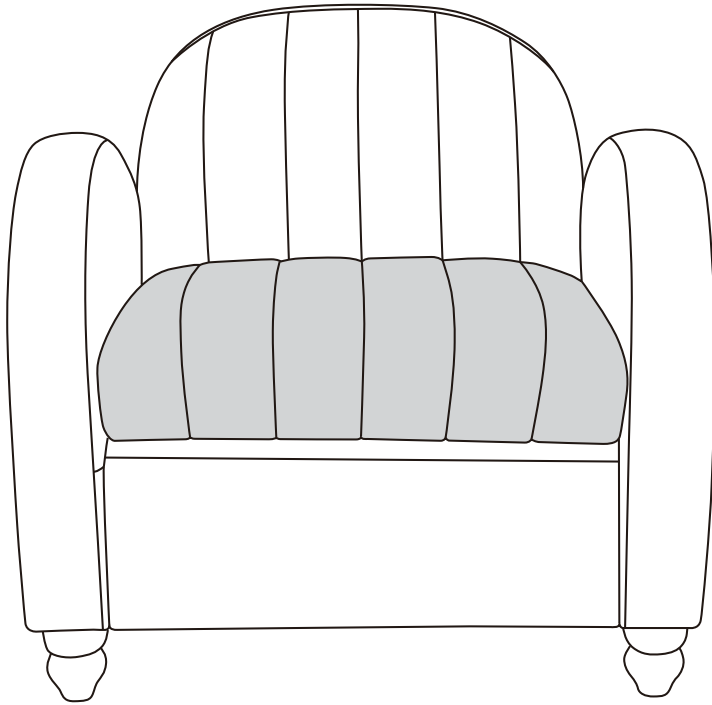

Missing something?

We work very hard to ship a perfect product, but sometimes furniture or hardware go missing or get damaged in transit.

Please contact us and we'll quickly make it right.