

MANUAL INSTRUCTION

Wicker Rocker Set

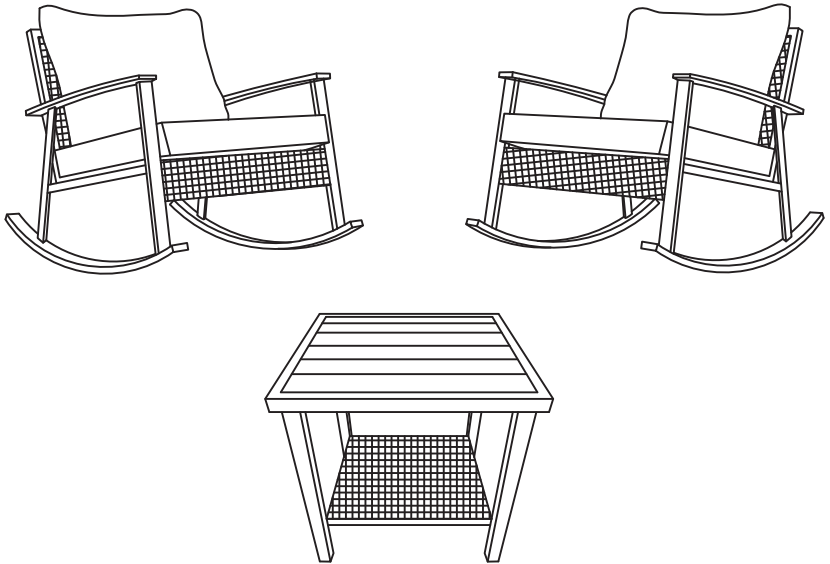

wicker rocker set



We offer a diverse range of products
to meet the needs of customers.

Reach us at

 service@kmcglobe-us.com

 (+1) 559-354-1889

PARTS

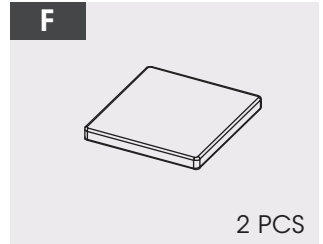
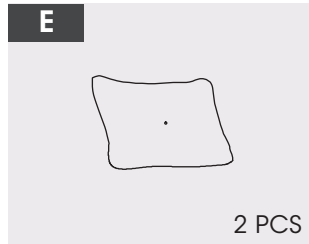
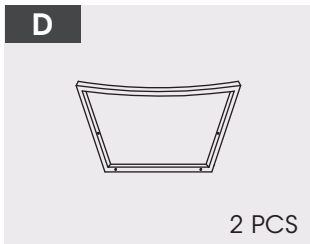
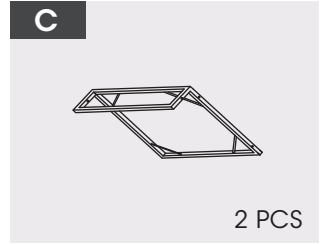
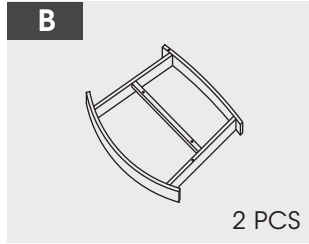
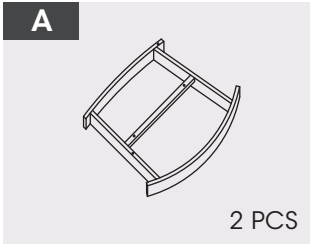
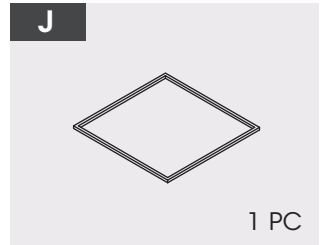
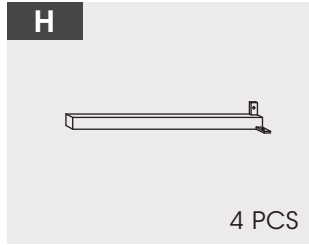
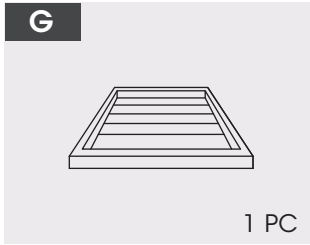



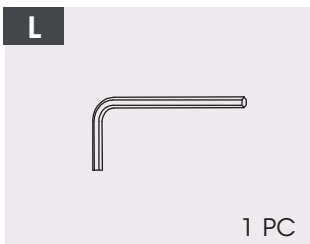
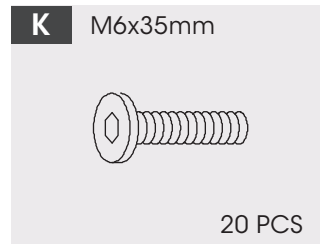
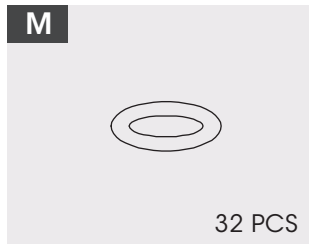

HARDWARE





I PRODUCT ASSEMBLY

1 Step 1

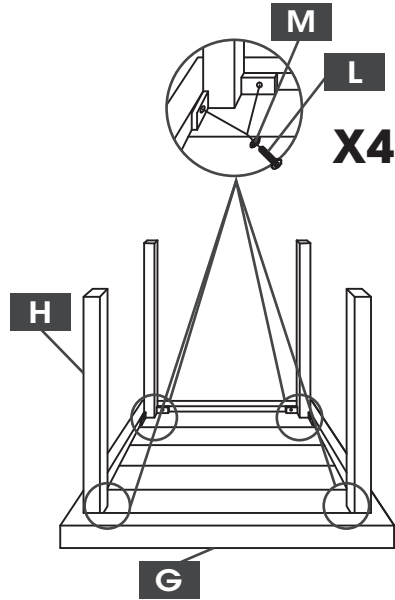
PART	NO.	QTY.
	G	1
	H	4
	L	8
	M	8





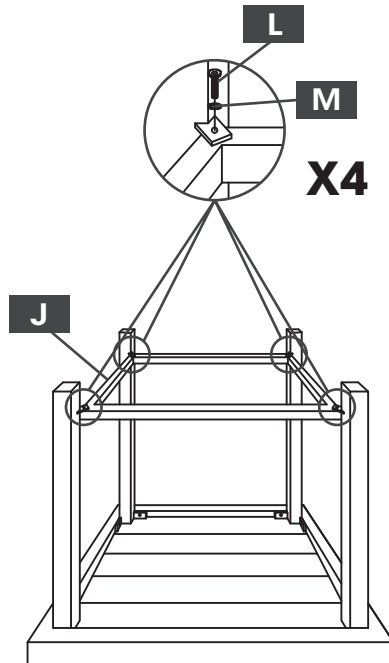

2 Step 2

PART	NO.	QTY.
	J	1
	L	4
	M	4





I PRODUCT ASSEMBLY

3 Step 3

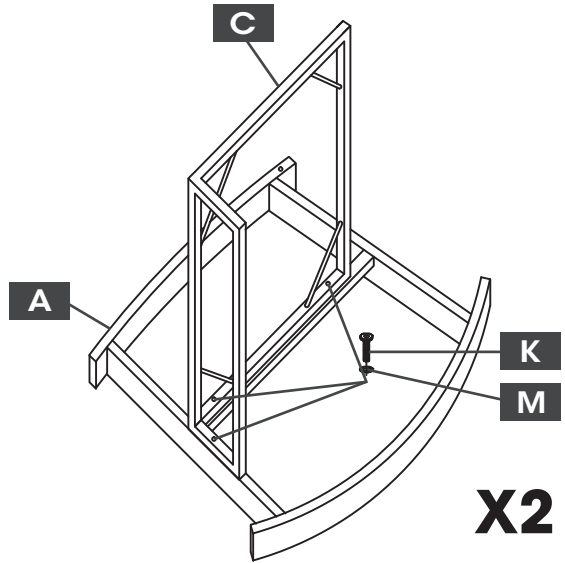
PART	NO.	QTY.
	A	2
	C	2
	K	6
	M	6



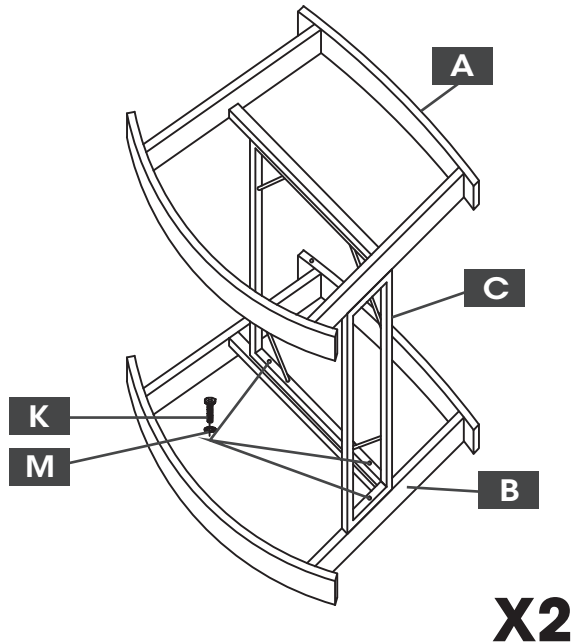

4 Step 4

PART	NO.	QTY.
	B	2
	K	6
	M	6





I PRODUCT ASSEMBLY

5 Step 5

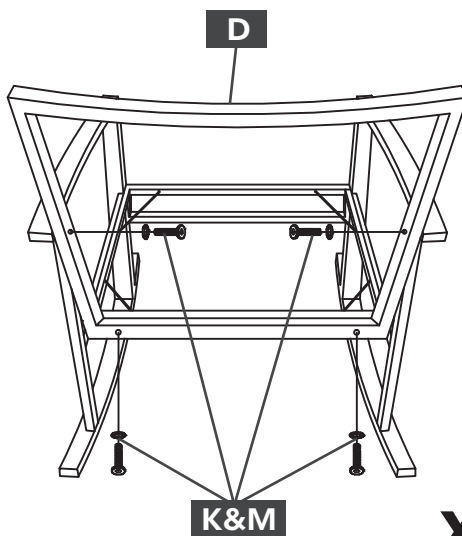
PART	NO.	QTY.
	D	2
	K	8
	M	8



6 Step 6

PART	NO.	QTY.
	E	2
	F	2

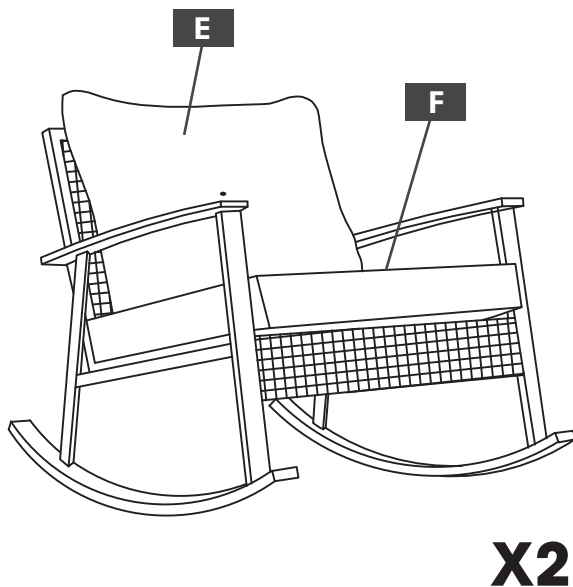

I HELP CENTER

Question about your product? We're here to help. Visit us at:

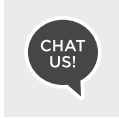

Chat Support



Product Inquiry

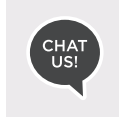

Orders FAQ

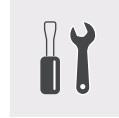

Product Assembly



Returns & Refunds

We Stand Behind the Quality of Their Furniture

If you have any issues with your item please let us know! We will always do our best to come up with a solution that you will be happy with.

Please get in touch with our customer service team before returning the product.

And pls do not throw the original box(es) if you have not finished assembling or confirmed no quality issues.

Length of return period:

Items can be returned within 30 days of purchase.

In the meanwhile, everything you purchased from us comes with a one-year warranty.

Who is responsible for the return shipping fee:

We will cover the return shipping fees if:

1. Your item has a manufacturing defect in its materials or workmanship. For example, torn wicker or misaligned screw holes. We will send you a prepaid shipping label after photos are sent.
2. Your item has been damaged in transit. For example, glass is broken or wicker is damaged. We will send you a prepaid shipping label after photos are sent.
3. You receive the wrong box(es) due to a warehouse error. We will send you a prepaid shipping label after photos are sent of the wrong SKU numbers on the outer box(es).
4. One or more boxes are lost in transit. We will send you a prepaid shipping label if you no longer want the item.

*However, we still hope to work with you for a better solution instead of a return. Please don't hesitate to contact our customer service team.

Customer will cover the return shipping fees if:

1. You don't like the product(s) after receiving the box(es).
2. You no longer need the product(s) but you have received the box(es).
3. You buy the product(s) by mistake but you have received the box(es).
4. Order/Shipment cancellation failed and you have received the box(es).

Return Request

In order to get a full refund as described in this return policy, all items must be: (1) In a brand new/unused condition, please provide photos before and after packaging. (2) When returning, all accessories and parts are firmly packed in all original packaging.

If your return does not meet the requirements, you may not get a full refund.

When will I be refunded?

The refund is released once the goods have been returned to our warehouse.

What if the product is damaged/defective outside of the valid return period?

We want you to be a happy customer. Please reach out to us by email and we will come up with a solution to make sure you are satisfied.