

Dining Chair

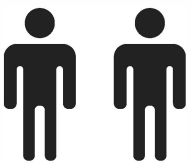
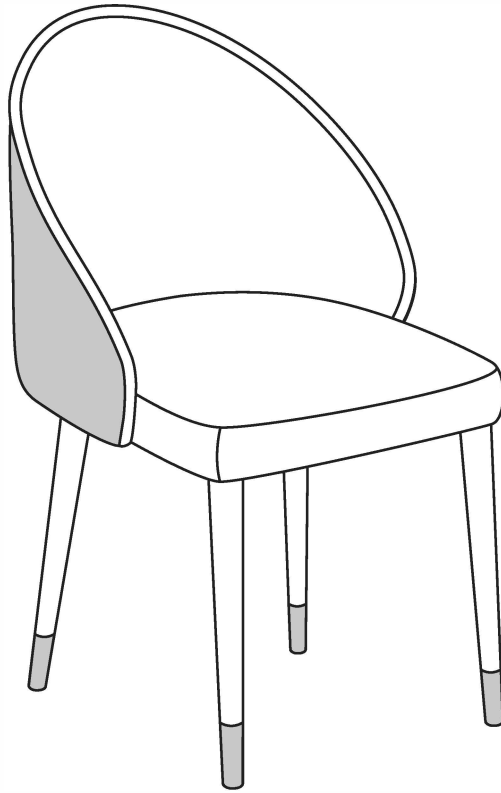

2 Persons

Installation Instructions

Notes: Don't tighten screws completely at first, just in case parts were assembled wrongly and need disassemble. Tighten screws at last when all parts are put together.

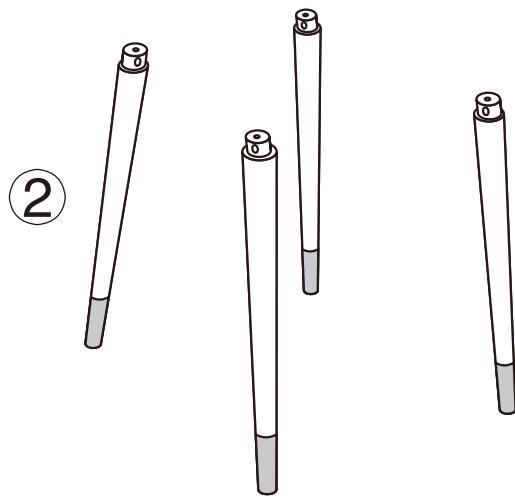
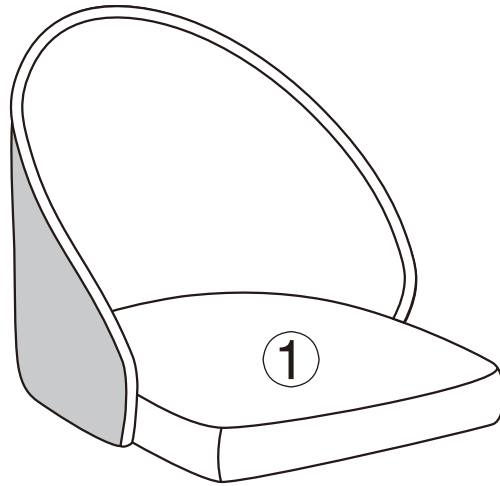

Disassembly and installation of accessories

1

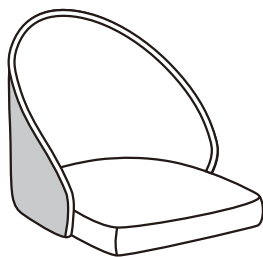

1 PCS

2

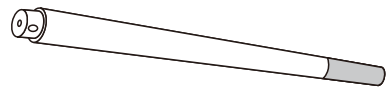

4 PCS

A 4PCS



15*10mm





Tools
Recommended

1

▲ Put the nut into the hole of the chair foot

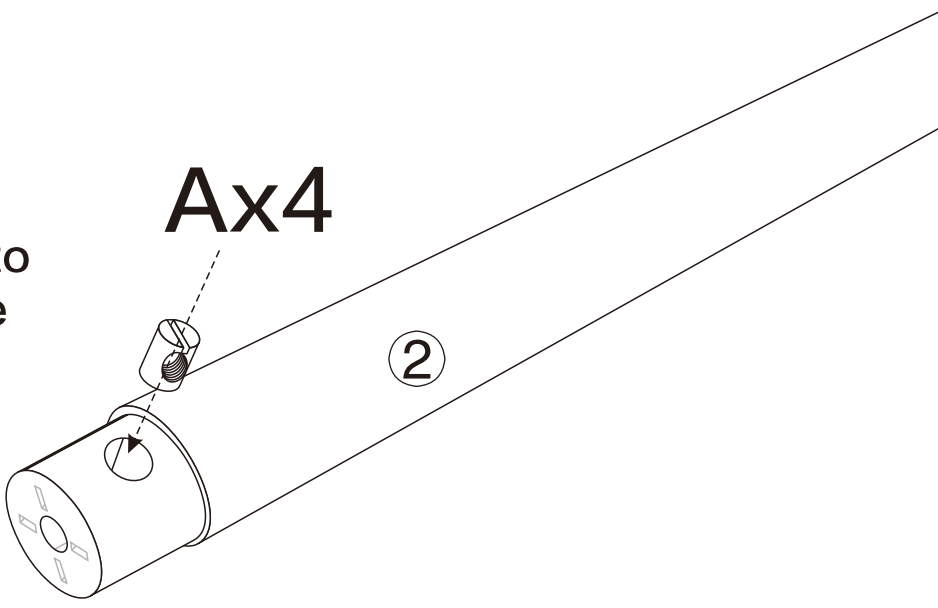
Ax4



A	4PCS
	
15*10mm	

2

