

# Installation manual

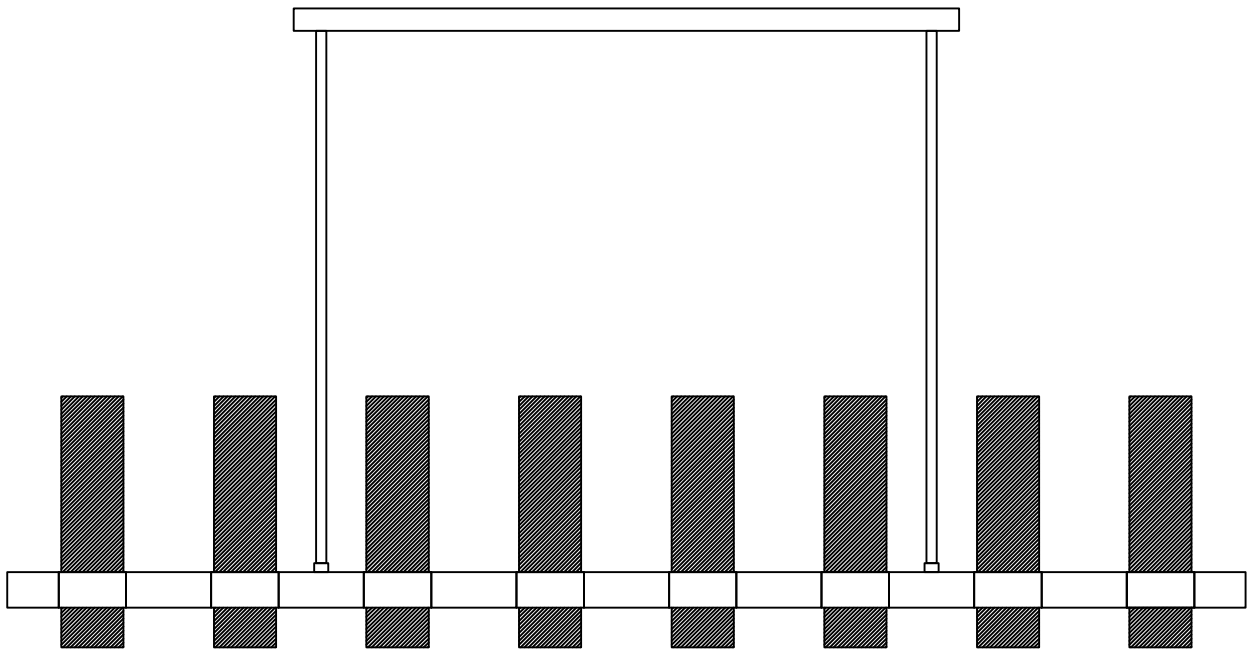

# Chandelier Installation and Safety Standards

The installation of a chandelier is a crucial step in ensuring its safety. Chandelier safety standards dictate the process of installation, including the tools and equipment that can be used, the methods of securing the chandelier, and the location of the chandelier.

Securing the chandelier is a crucial step in the installation process. Chandelier safety standards dictate that the chandelier must be securely attached to a suitable support, such as a ceiling joist, to prevent it from falling. This includes ensuring that the support is strong enough to bear the weight of the chandelier, and that the chandelier is properly balanced to prevent it from tipping or swaying.

Furthermore, the chandelier must be secured using suitable hardware, such as screws or bolts, that are strong enough to bear its weight. The hardware must be properly installed and tightened to ensure that the chandelier is securely attached. Regular inspections of the hardware are also necessary to detect and repair any damage or wear promptly.

# Packaging Illustration

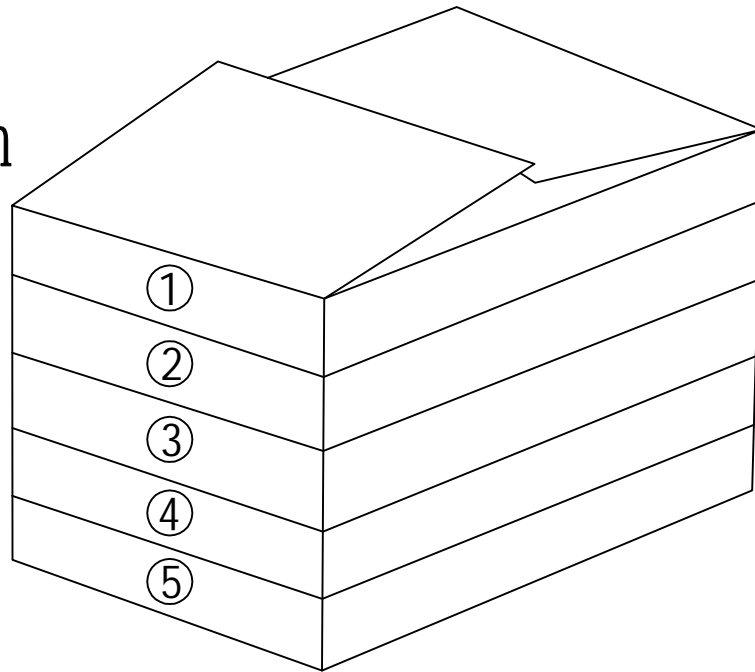

①

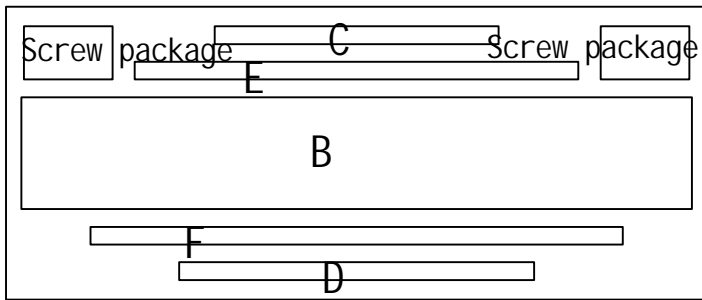

②

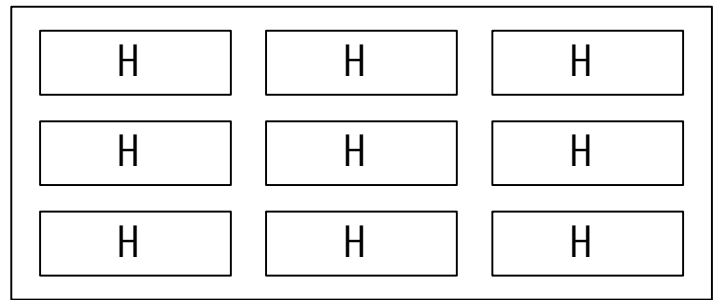

③

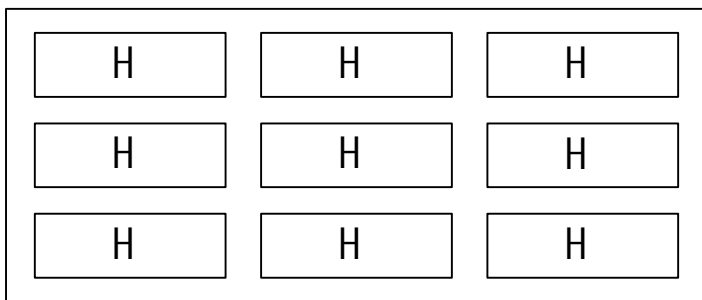

④

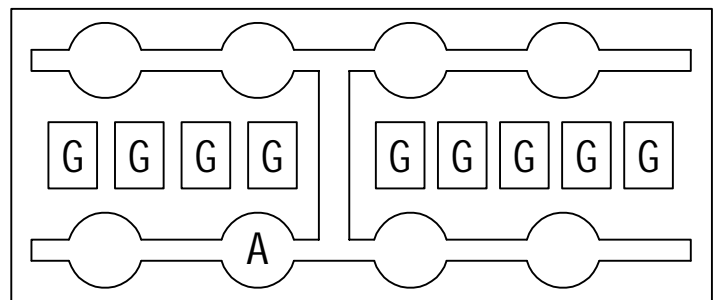

⑤

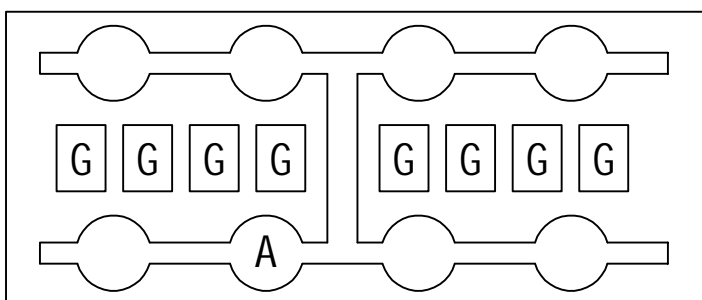

## Internal packing list:

- 1, The first layer of ceiling tray + round tube + accessories package
- 2, The second layer of glass lampshade
- 3, Third glass lampshade
- 4, Fourth layer lamp body + glass lamp holder
- 5, The fifth layer of lamp body + glass lamp holder

## Before assembly:

- ★ Please read all the instructions carefully
- ★ Keep the instruction manual for future reference.
- ★ Separate and inventory all parts and hardware
- ★ Read each step carefully and follow the correct installation sequence
- ★ To avoid losing any parts during assembly, we recommend not moving the lamp before completing the assembly. Always place the product on a flat, firm, and stable surface
- ★ Keep all small parts and packaging materials of this product away from babies and children, as they may cause serious injury

# Accessory List

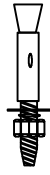

4pcs



2+2pcs

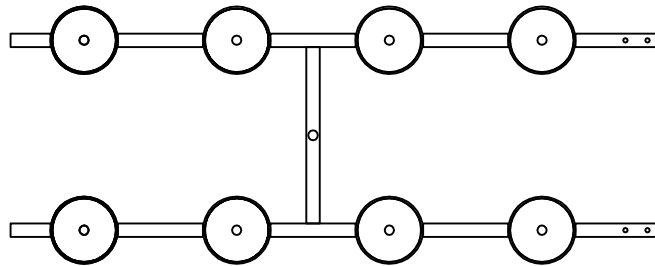

A. Lamp Body-2pcs

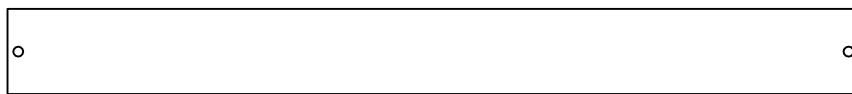

B. Canopy-1pcs

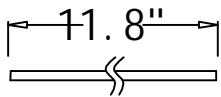

C. Tension rod  
round tube-2pcs

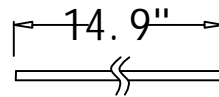

D. Tension rod  
round tube-2pcs

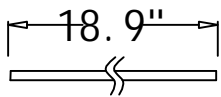

E. Tension rod  
round tube-2pcs

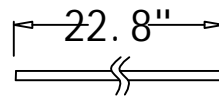

F. Tension rod  
round tube-2pcs



G. Glass Shade-16+1pcs

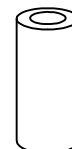

H. Glass shade-16+2pcs

# ① Lamp body assembly

- (1), Find the lamp body from the sorting list.
- (2), Assemble the A lamp body according to the drawing and link the assembly plug.
- (3), Take out the rod tube, and pass the power cord through the tube. (As shown in the picture below)
- (4), Connect the lamp body and ceiling tray with screws, and insert the power cord into the ceiling tray.

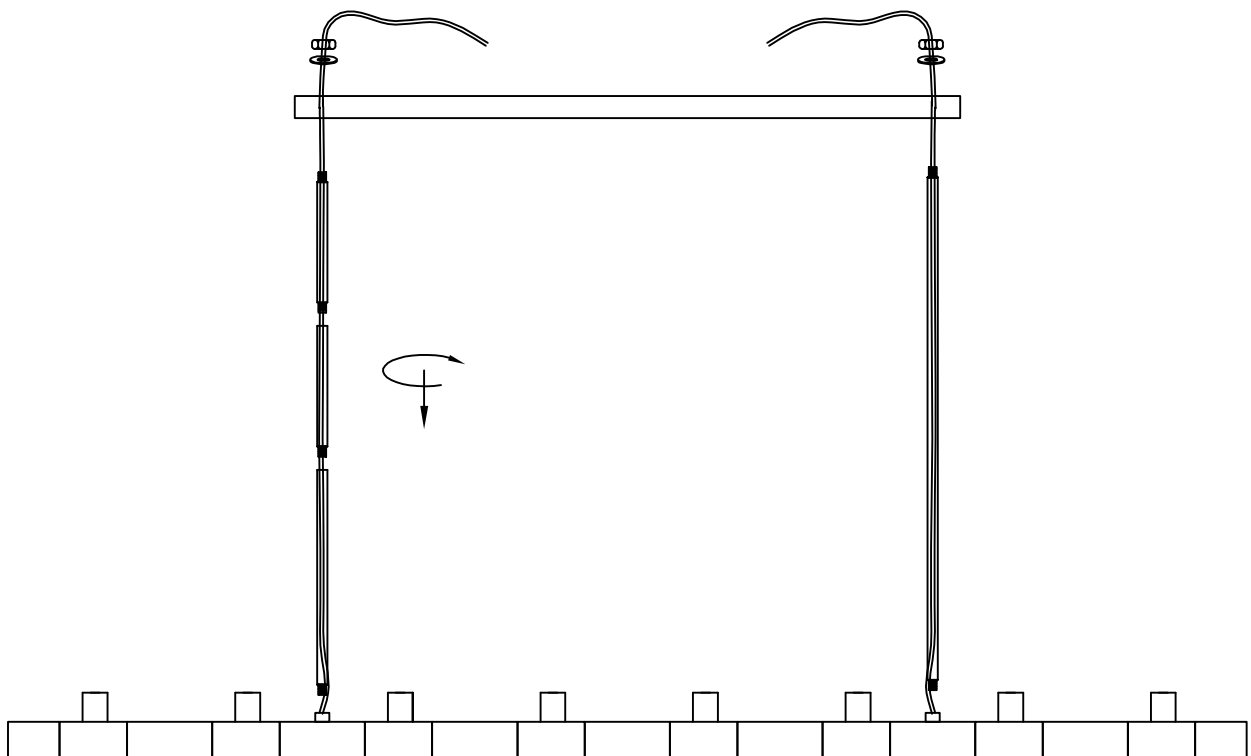
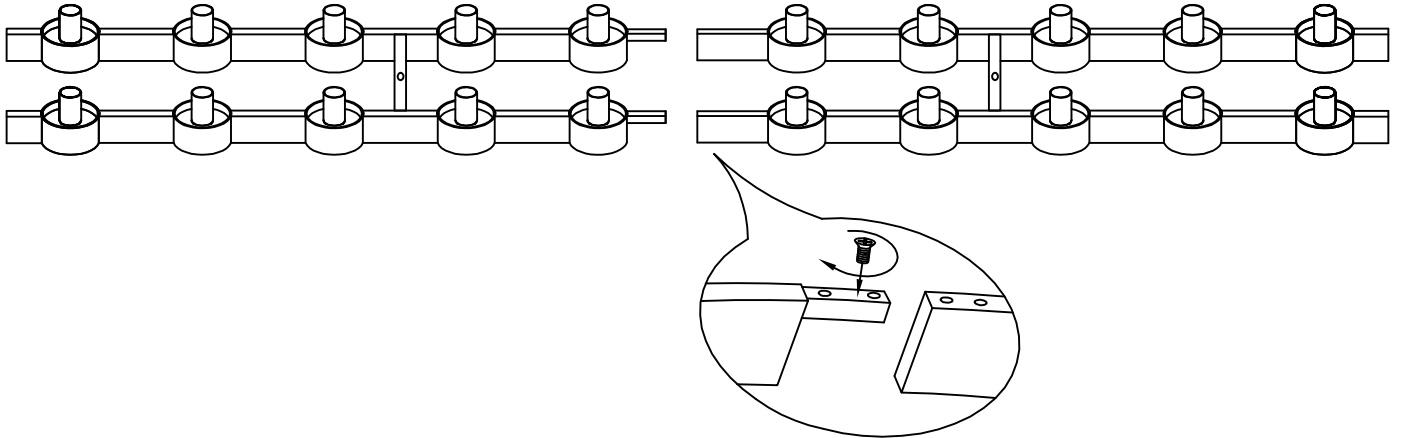

## ②Light Source and Bulb Assembly:

- (1), Take out the ceiling plate and link with the wall
- (2), Link the main line of the power supply with the main line of the lamp body and lock the ceiling plate.
- (3), Screw 16pcs E12 bulbs into the lamp head (not included in the product)
- (4), Install the long and short glass lamps into the light body sequentially.
- (5), Installation is complete.

