

Open the package, find the installation manual, read it carefully, put on gloves, check if all lamp heads are damaged. After confirming that there is no damage, take out the entire lamp and test it with power to ensure that it works normally. (Do not install the crystal lamp body during the test) Install according to the installation steps in the manual

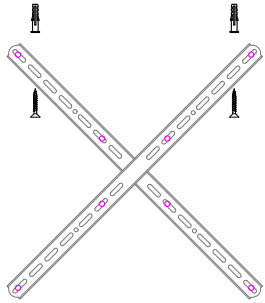

Install the reinforced cross hanging board onto the ceiling and conduct a load-bearing test to ensure it is securely installed before proceeding to the next step of installation

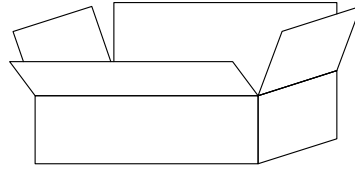
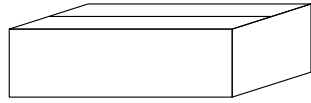
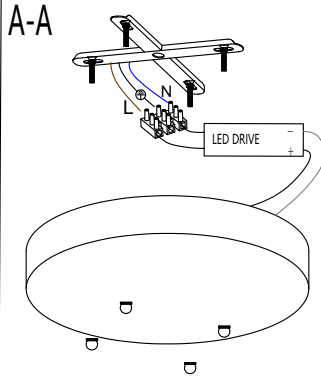

Install the entire lamp that has been tested for power on onto the securely installed cross hanging plate. If the lamp is heavy, more people are needed to help install it. When connecting the wires, please confirm whether the power has been cut off, tighten the hanging plate nut, and finally wipe the surface of the lamp panel clean. After turning on the power and

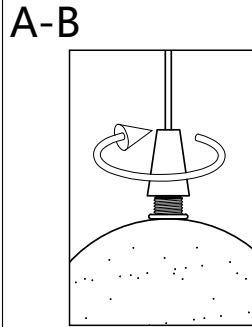

The final step is to install the lampshade. Please refer to the installation diagram of the crystal lamp body. After installation, adjust the height of the lamp body according to the shape and press the switch to turn on the power. The beautiful lamp will be displayed in front of you.

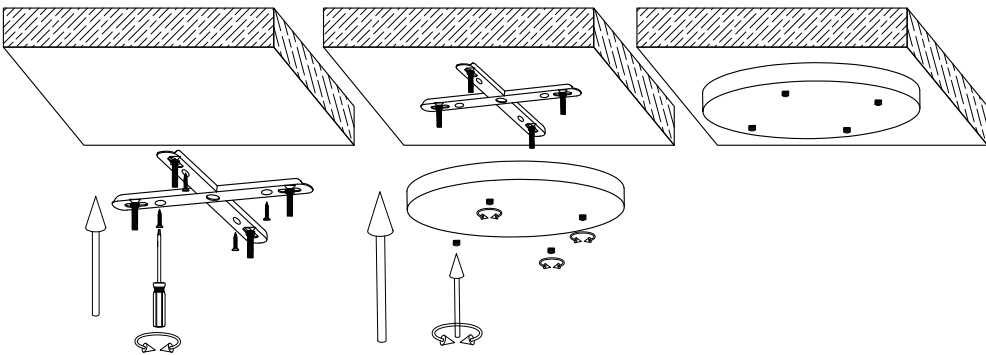

A-A Installation diagram of large chassis

Installation diagram of crystal lamp body

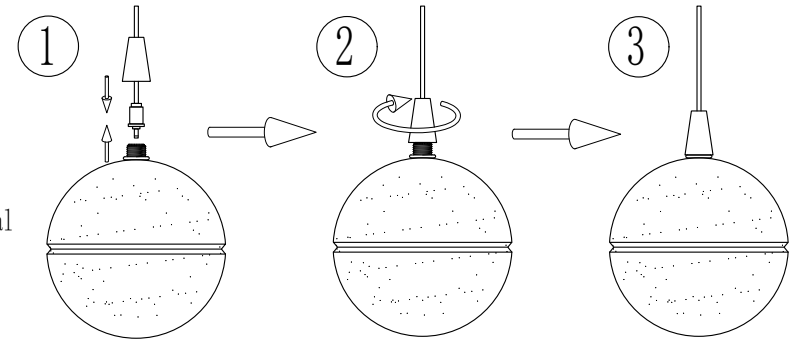

A-B

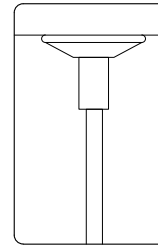

Press this pin could adjust the height

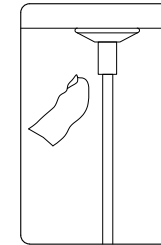

Using your finger

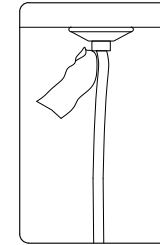

Press and hold the locking pins into the canopy

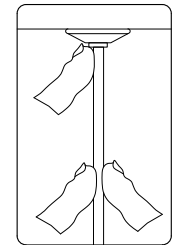

While holding the locking pin, pull down or push up the chain to adjust the height

A-C

High Voltage Connection (With Driver)  
Parallel connection

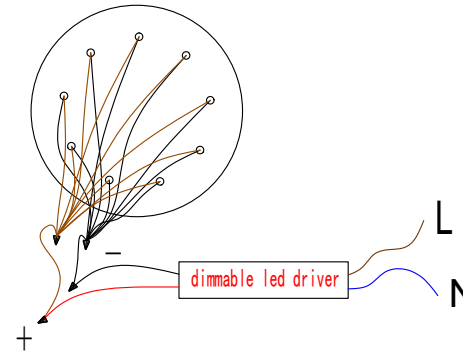

It is not possible to test the power alone, and all the lamp heads must be connected to the drive together. Be sure to connect the drive first and then connect the zero fire wire.

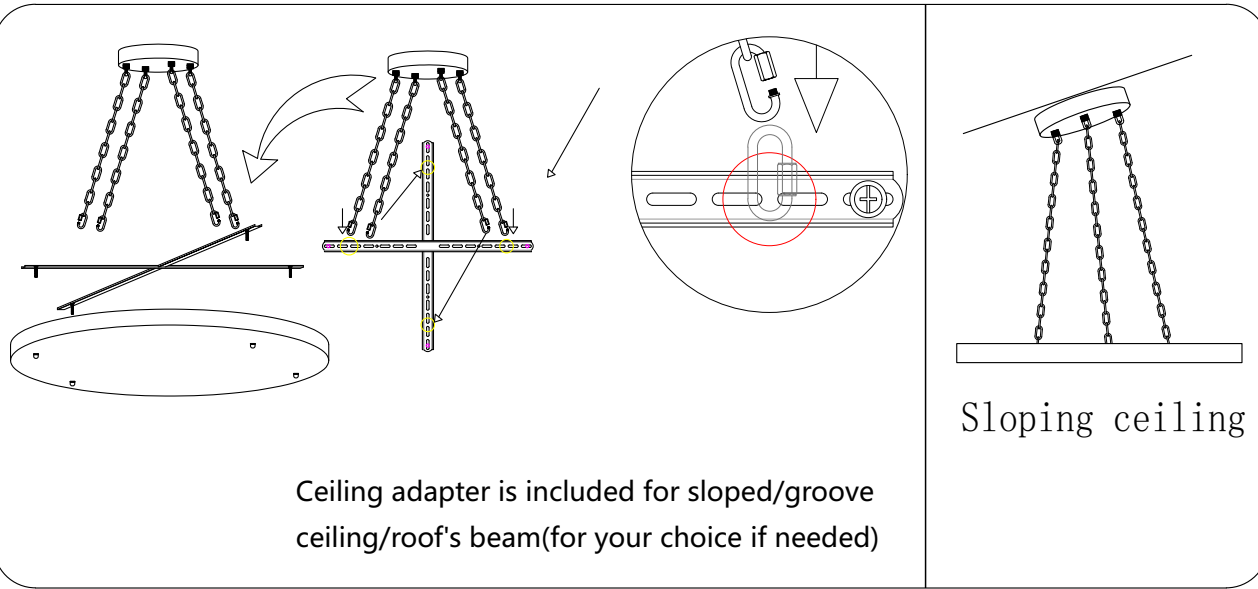

Ceiling adapter is included for sloped/groove ceiling/roof's beam(for your choice if needed)

Sloping ceiling

## Two way to control the chandelier: Remote control and mobile phone APP

1. Remote control-Just install the battery (not included) and ready to use. No need to pair the code. The detailed operating instructions of the remote control are in the bag that contains the remote control. Please check it.
2. Pls Turn on Bluetooth on your phone and scan the QR code to download and install the APP

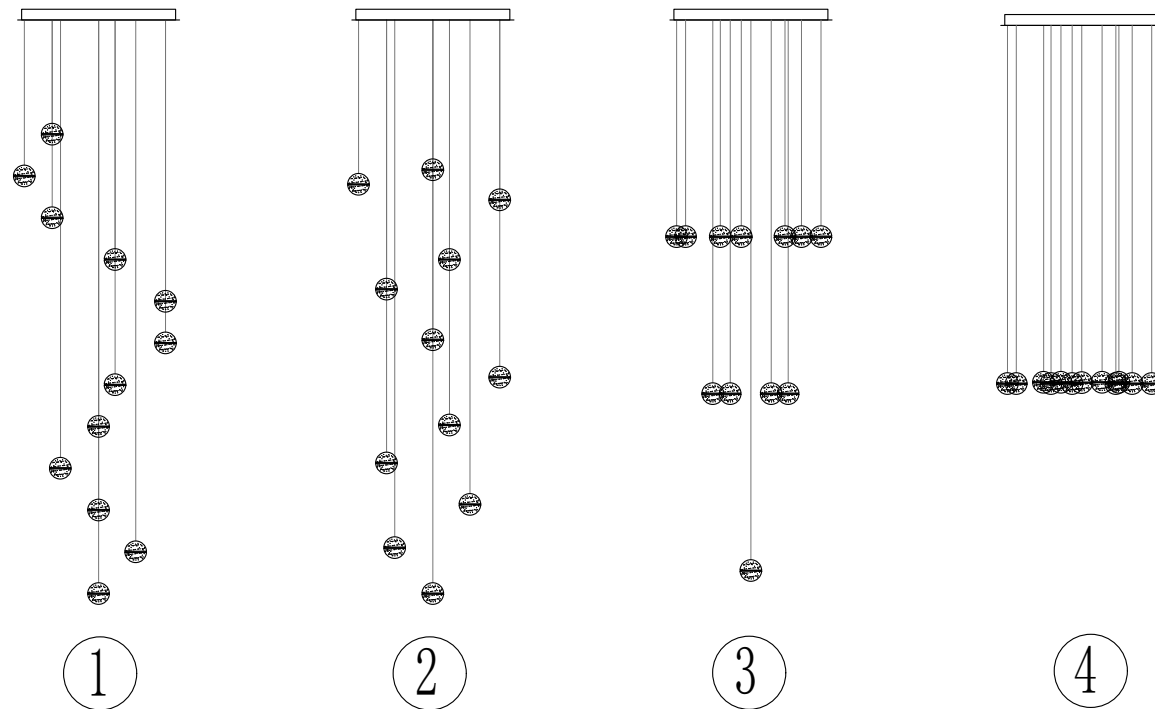

1

2

3

4

## Lighting Installation Instructions

### PREPARATION

- Consult a qualified, licensed electrician to ensure correct branch circuit conductor.
1. Shut off the power at the circuit breaker and remove existing fixture, including the crossbar.
  2. Carefully unpack your new fixture and lay out all the parts on a clear area. Be careful not to lose any small parts necessary for installation.

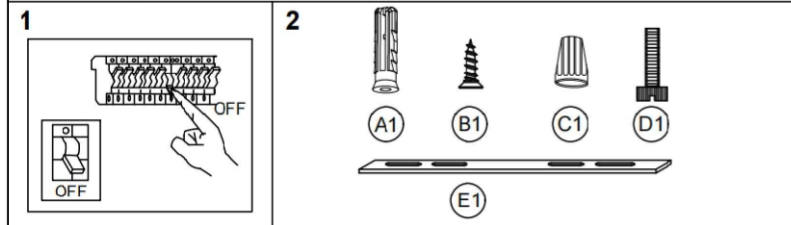

- Please read all included assembly instructions and warnings carefully before installation. Contact Customer Service if you have any questions or concerns. Before installation, please confirm that the fixture is compatible with your supply voltage and dimming system, if present.
- LEDs are highly sensitive electronic devices, and must be treated with care. Do not open any factory sealed compartments, and avoid touching the LEDs with your hands or any object.

PLEASE CONFIRM THE TYPE BEFORE INSTALLATION