

Assembly Instruction









CHAIR

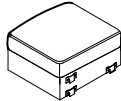
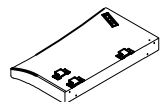
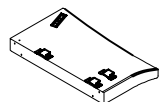

Legs & hardware are packed in the box and stored inside of the carton, please take out for assembly.

Note: Do not use power tools for assembly. Power tools increase the risk of over tightening which lead to splitting or cracking the wood.

Component list

| No | Drawing | Qty | Description |
|----------|---|----------|--|
| A |  | 1 | Chair Seat |
| B |  | 1 | LSF Armrest |
| C |  | 1 | RSF Armrest |
| D |  | 1 | Backrest |
| E |  | 4 | Metal Legs (130*85*85mm) |
| F |  | 1 | Crossbar |
| G |  | 8 | Bolt (5/16"*22mm) |
| H |  | 8 | Flat washer 5/16"*Ø19*1.5mm |
| I |  | 2 | Bolt (1/4"*35mm) |
| J |  | 2 | Flat washer 1/4"*Ø16*1.5mm |
| K |  | 1 | Allen key (M4*59mm) |

THE PARTS ARE LOCATED INSIDE THE BOX AS BELOW:

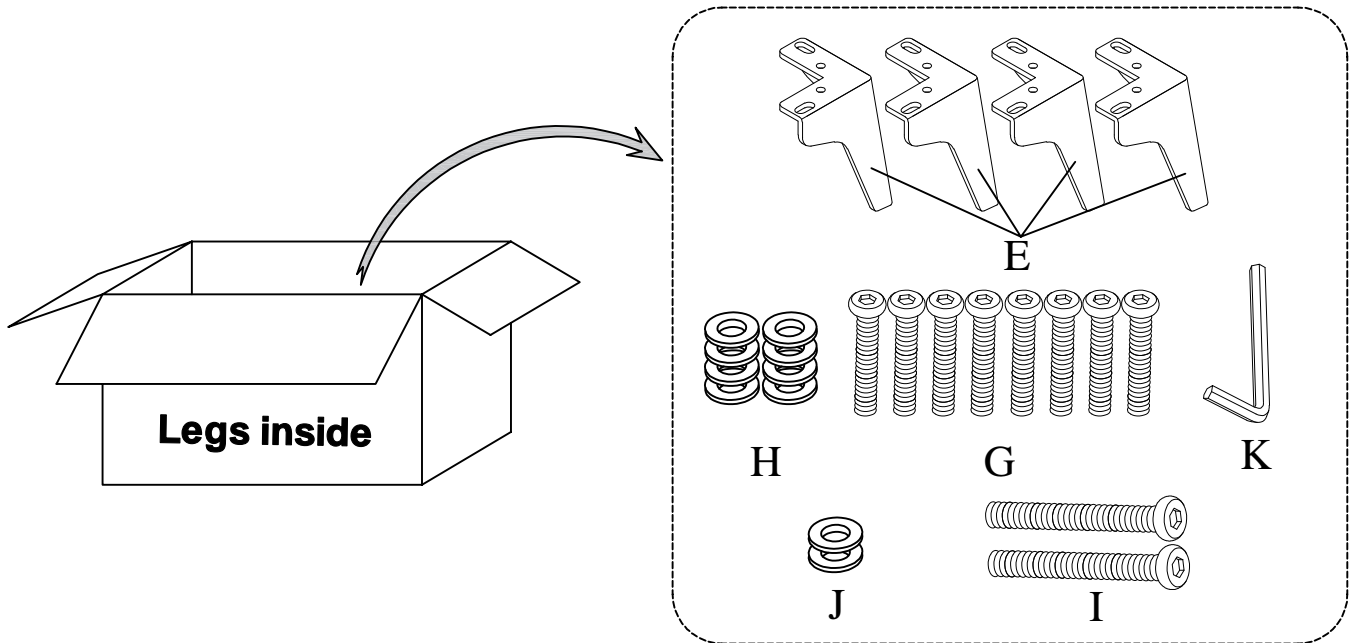
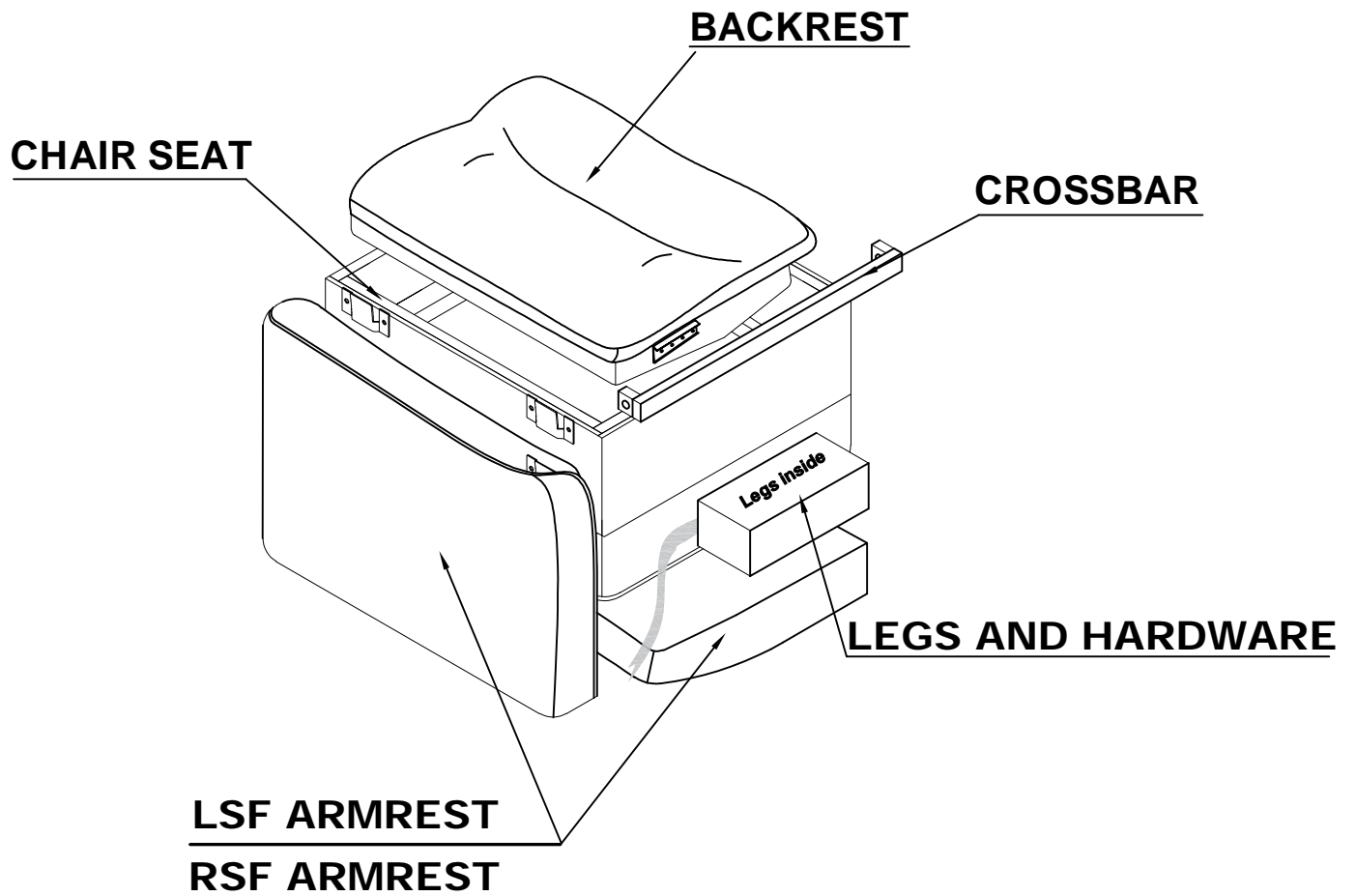

Step #1

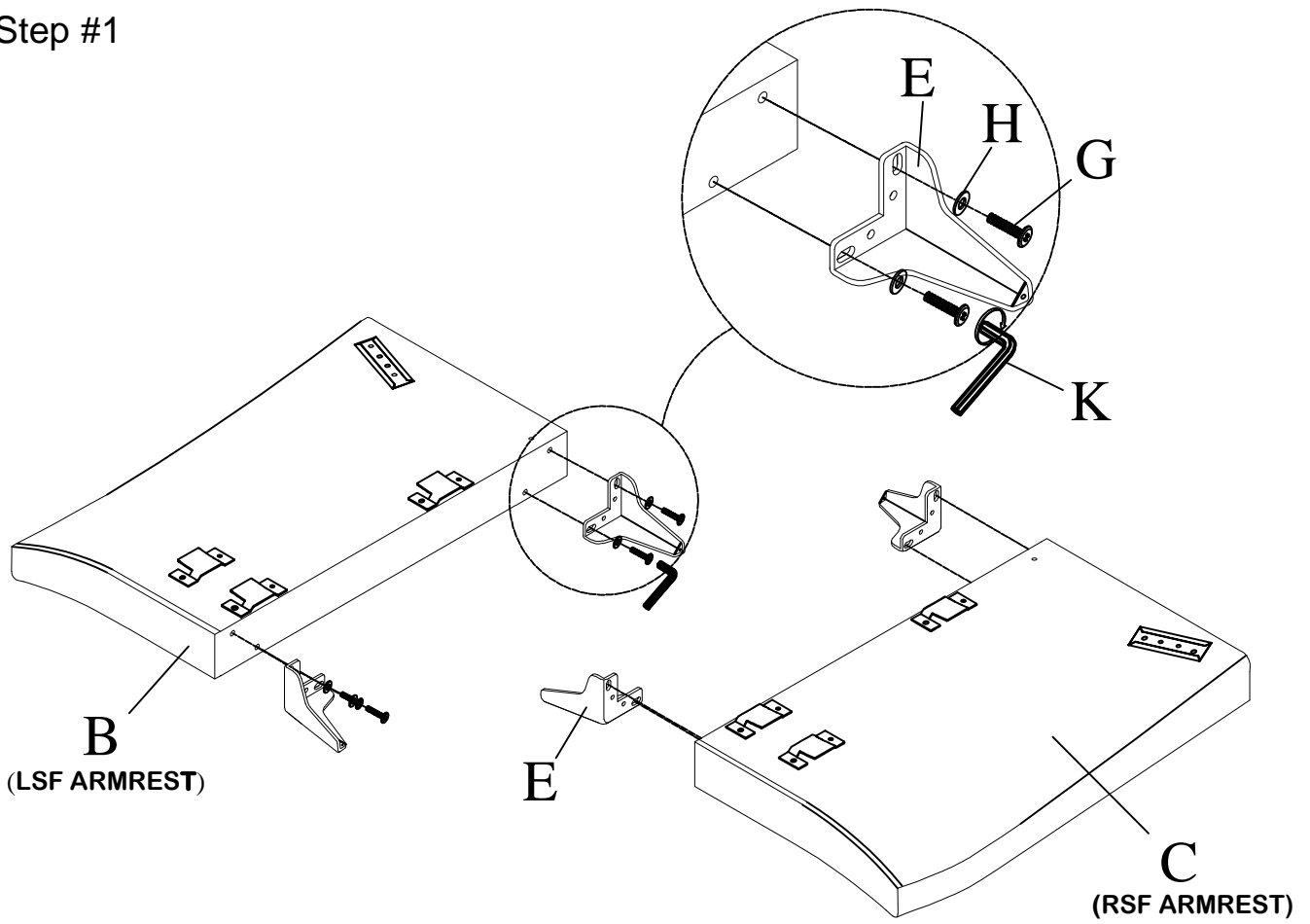

Step #2

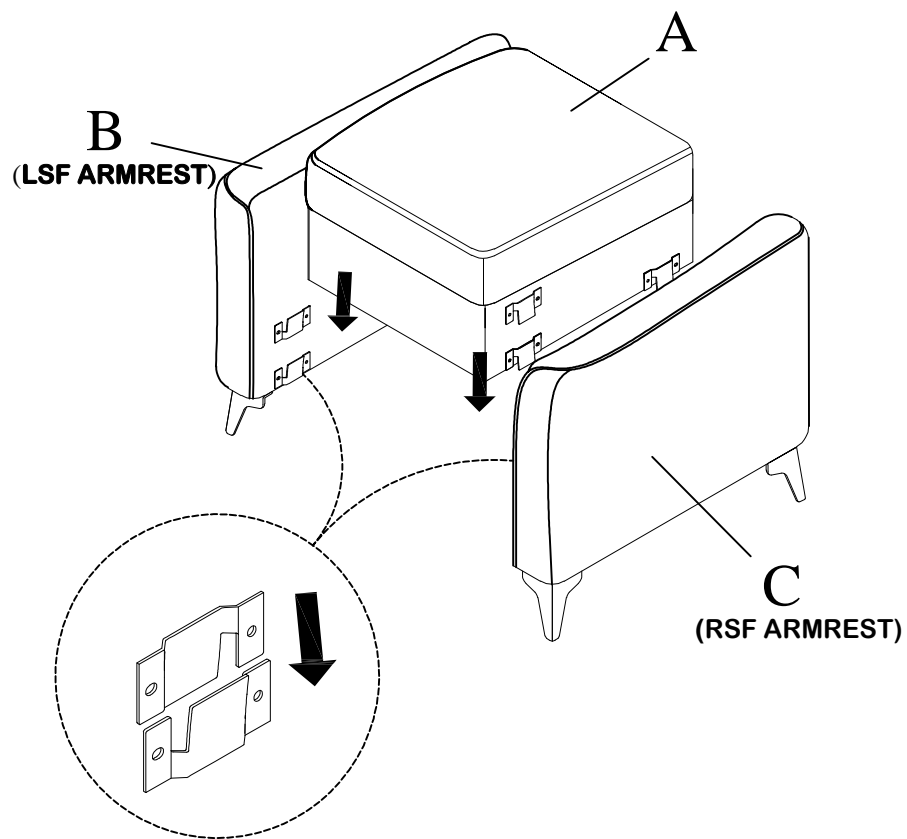

Step #3

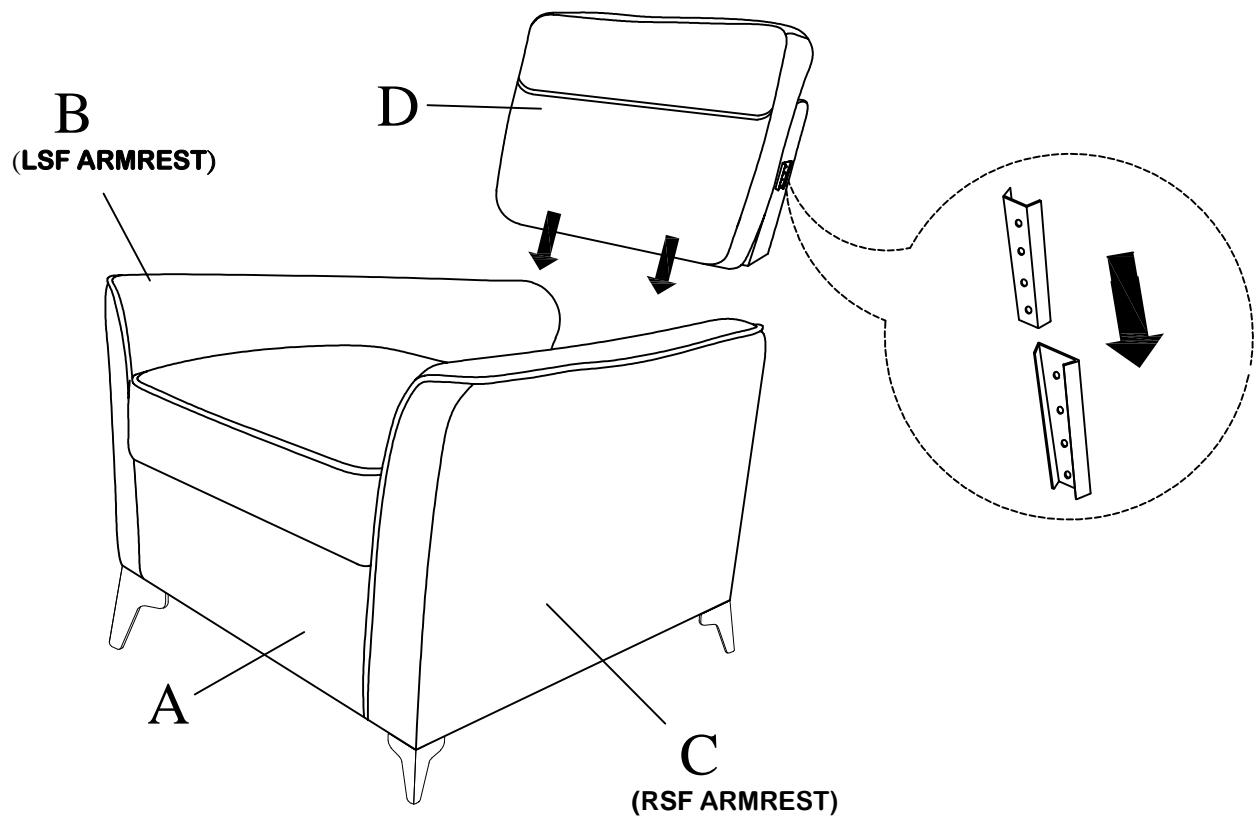

Step #4

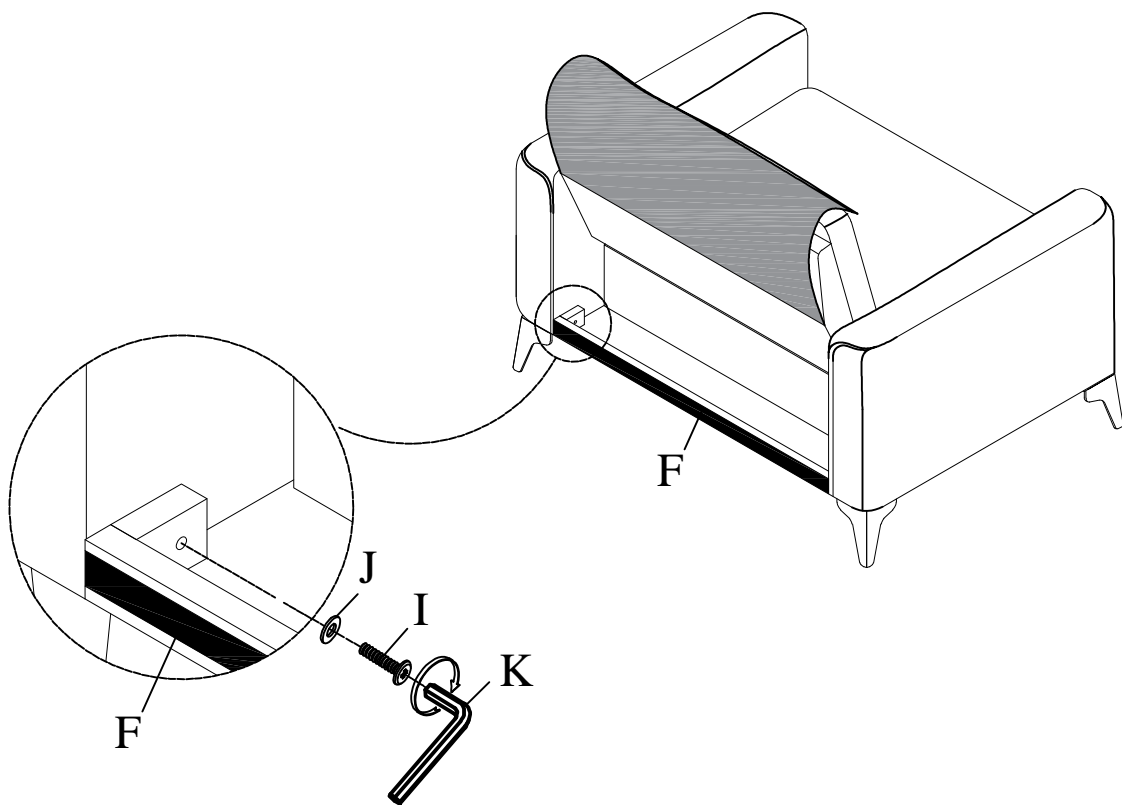

Step #5

Assembly completed.

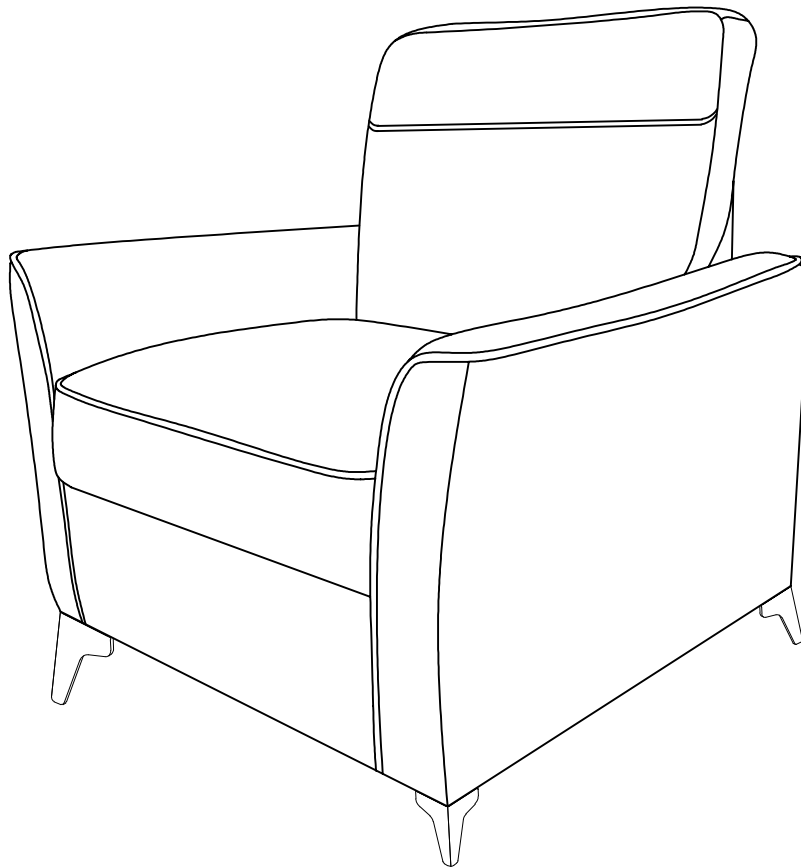

Care Instruction for Textured Microfiber Furniture:

In order to maintain the original appearance of your textured microfiber, please follow below simple care procedures:

- Avoid exposing furniture directly to sunlight or heating and air conditioning outlets. Sunlight and/or exposure to heating and air conditioning outlets will fade/damage textured microfiber. Do not place your upholstered furniture too close to windows, radiators, or vents, and be sure to use windows, radiators, or vents.
- Vacuum or wipe with a soft cloth to remove dust.
- Hardware may loosen over time. Periodically check to make sure all connections are tight. Re-tighten if necessary.



For items use on wooden floor, hard surfaces or carpets, it is recommended to Install protective pads under all legs and supports to avoid/prevent from damages/scratches and discoloration.