

3

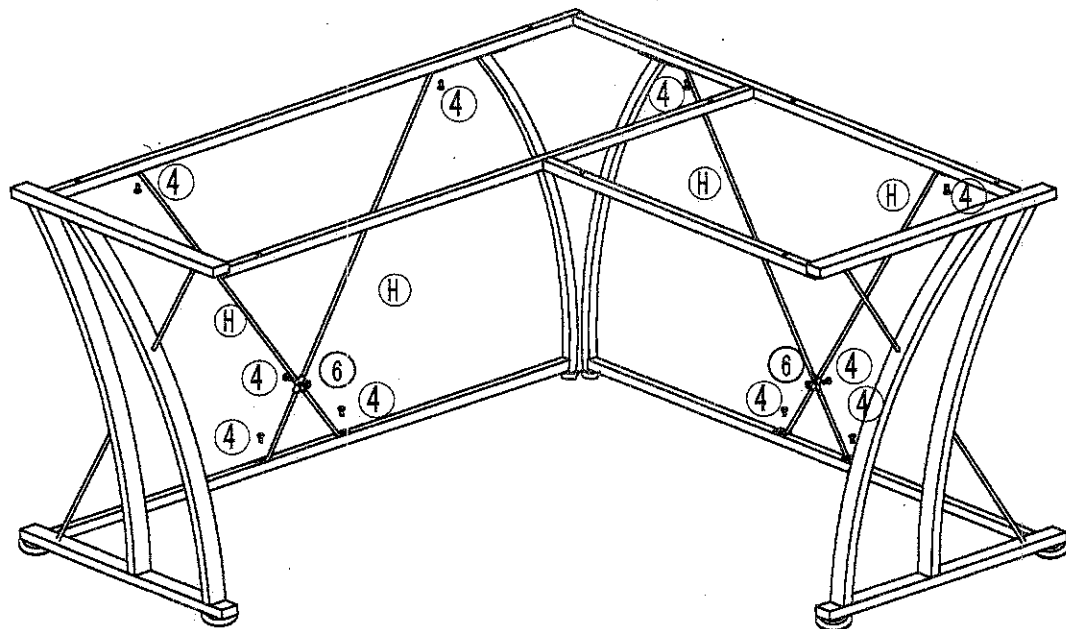

- ④ X10
- ⑥ X2

4

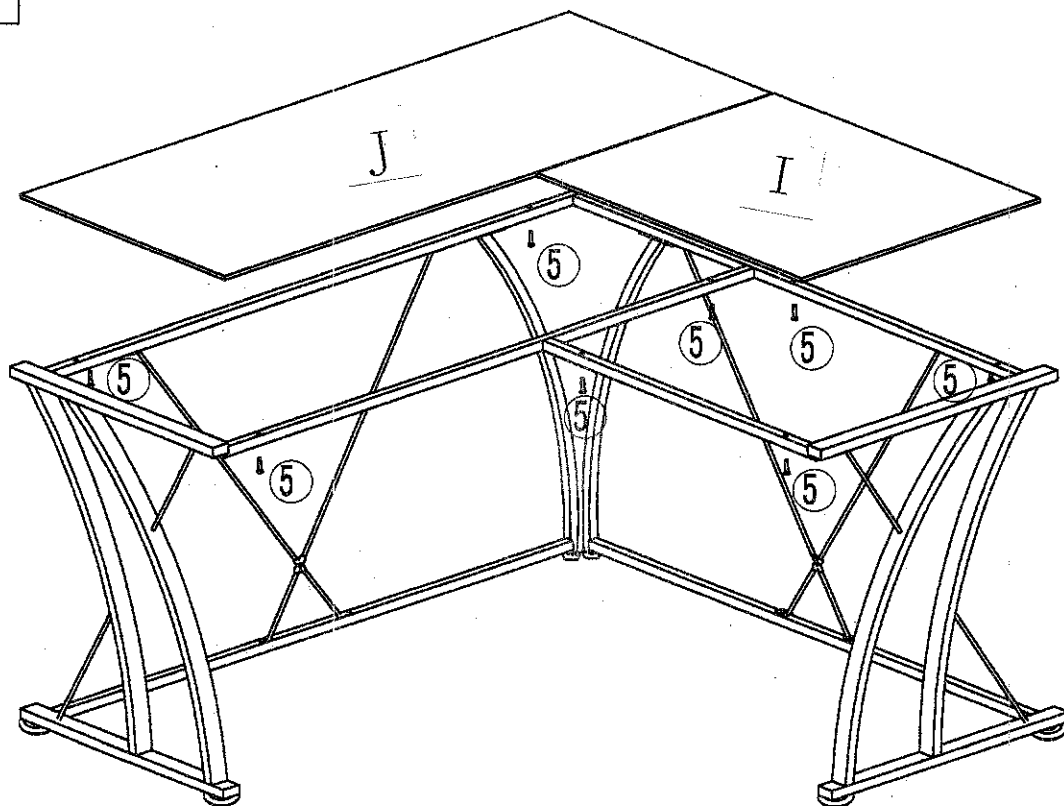

- ⑤ X8

1

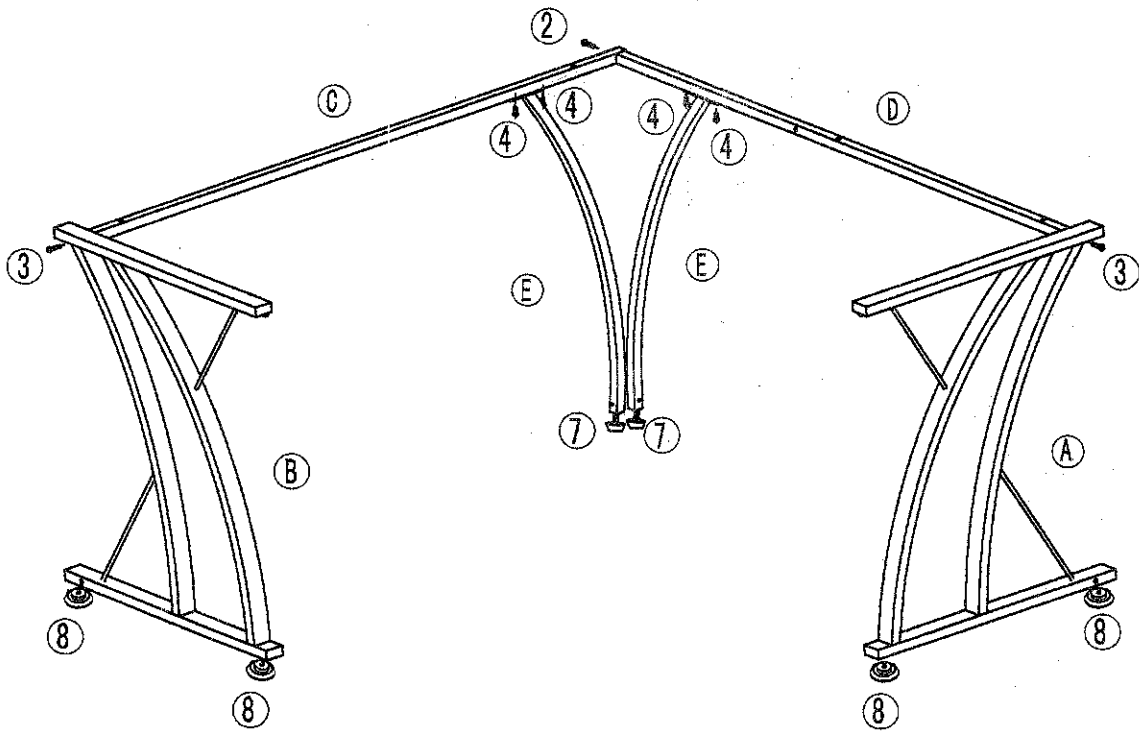



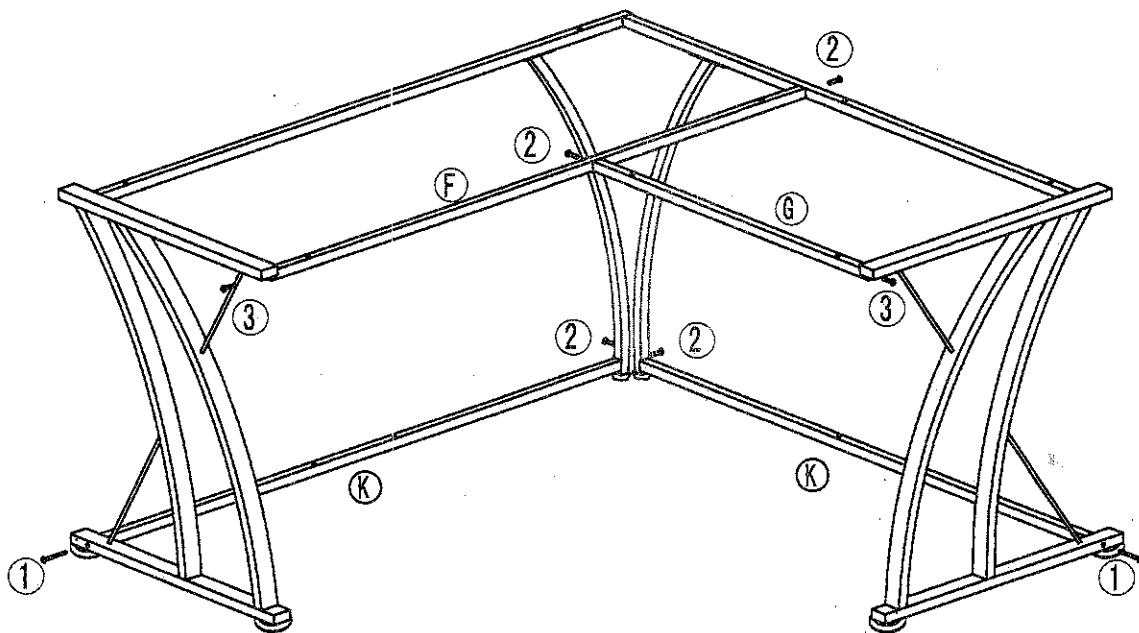

- ② X1
- ③ X2
- ④ X4
- ⑦ X2
- ⑧ X4





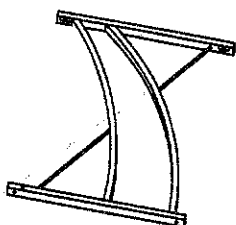
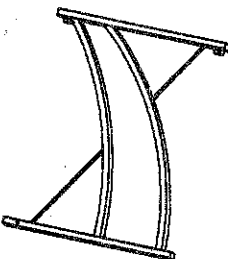
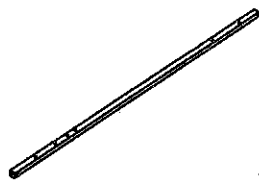
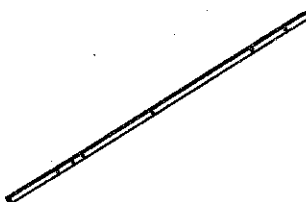

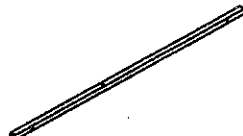
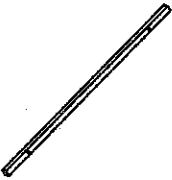

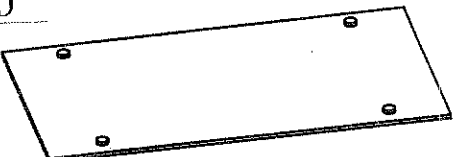
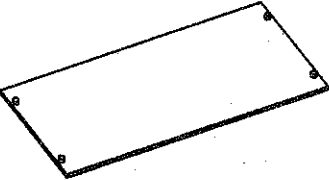
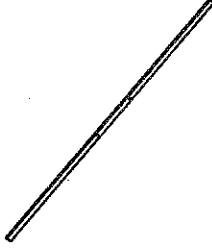
2



- ① X2
- ② X4
- ③ X2

# PART

<p><b>A</b></p>  <p>x1</p>	<p><b>B</b></p>  <p>x1</p>	<p><b>C</b></p>  <p>x1</p>
<p><b>D</b></p>  <p>x1</p>	<p><b>E</b></p>  <p>x2</p>	<p><b>F</b></p>  <p>x1</p>
<p><b>G</b></p>  <p>x1</p>	<p><b>H</b></p>  <p>x4</p>	<p><b>J</b></p>  <p>x1</p>
<p><b>I</b></p>  <p>x1</p>	<p><b>K</b></p>  <p>x2</p>	

<p><b>1</b></p>  <p>M6x55 X2</p>	<p><b>5</b></p>  <p>M6X25 X8</p>
<p><b>2</b></p>  <p>M6X35 X5</p>	<p><b>6</b></p>  <p>X2</p>
<p><b>3</b></p>  <p>M6X20 X4</p>	<p><b>7</b></p>  <p>M6 X2</p>
<p><b>4</b></p>  <p>M6X12 X14</p>	<p><b>8</b></p>  <p>X4</p>

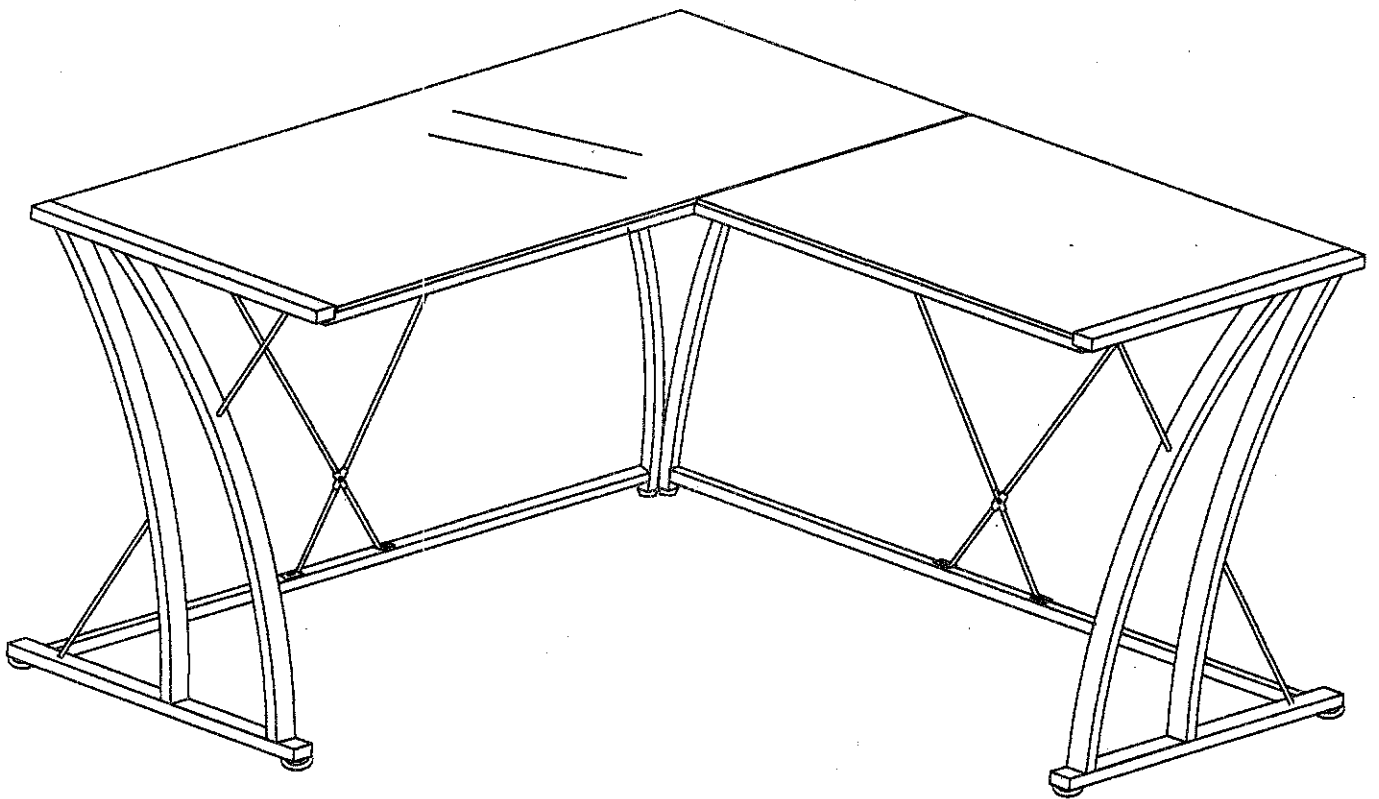

IMPORTANT: DON'T FASTEN BOLTS UNTIL ALL PARTS IN POSITION.