

# ASSEMBLY INSTRUCTION

ITEM NO.:81352

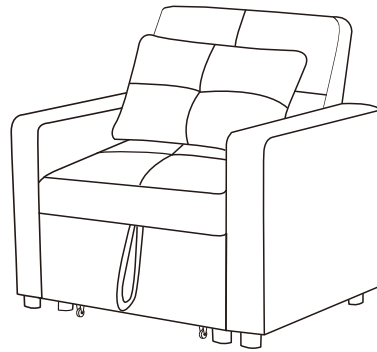

## PARTS LIST

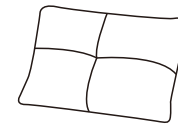
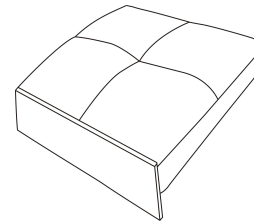
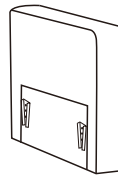
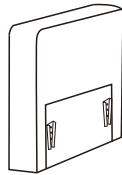
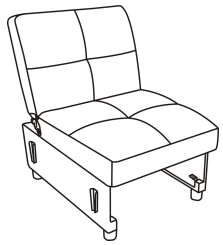

**A**

x1

**B**

x1

**C**

x1

**D**

x1

**E**

x1

## HARDWARE LIST

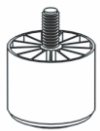

**1**

x8

**2**

x8

**3**

x4

**4**

x1

**Step 1**

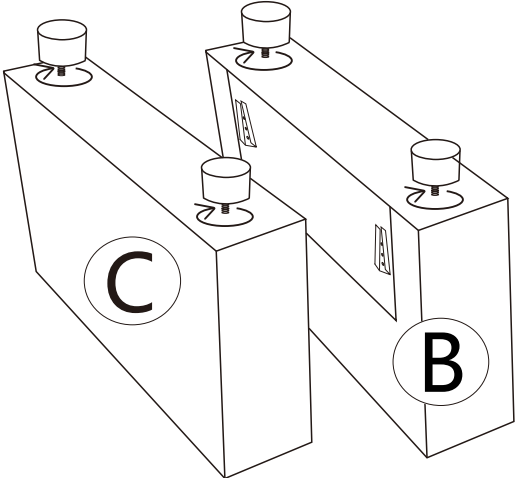
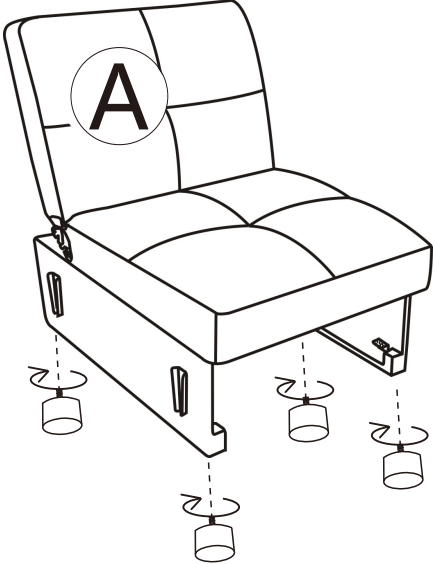
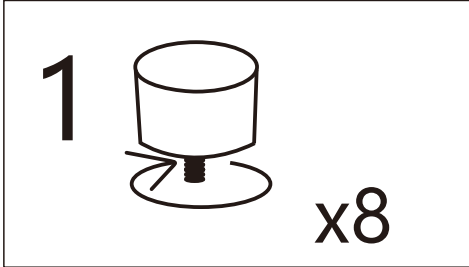

## Step2

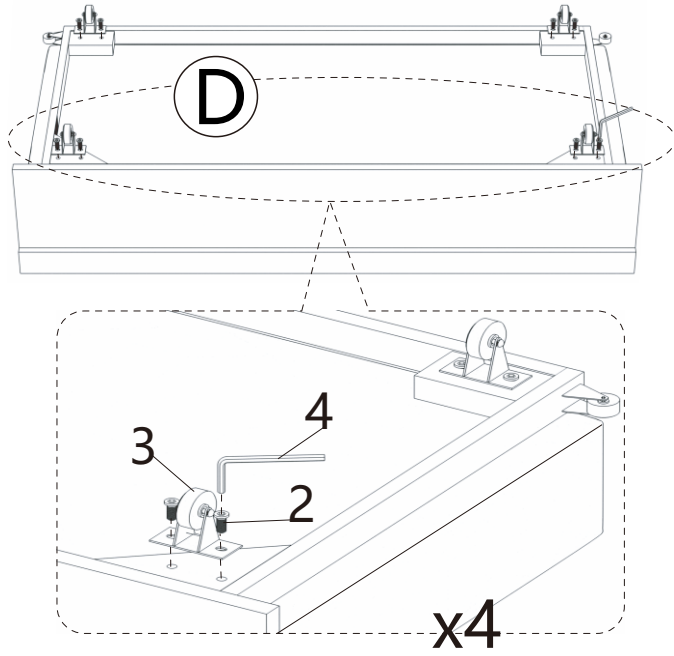

## Step3

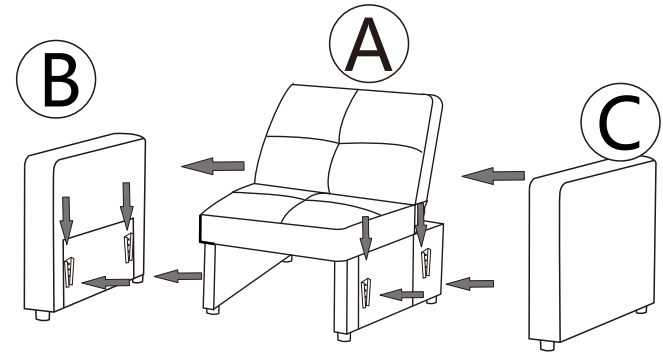

## Step4

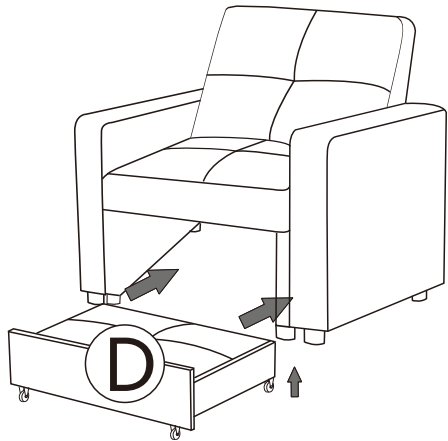

## Step5

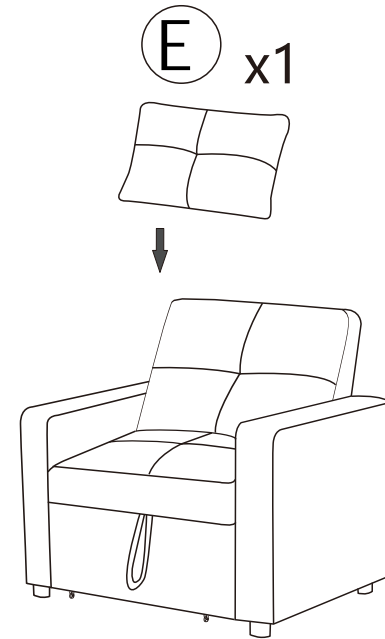

**Step 6**

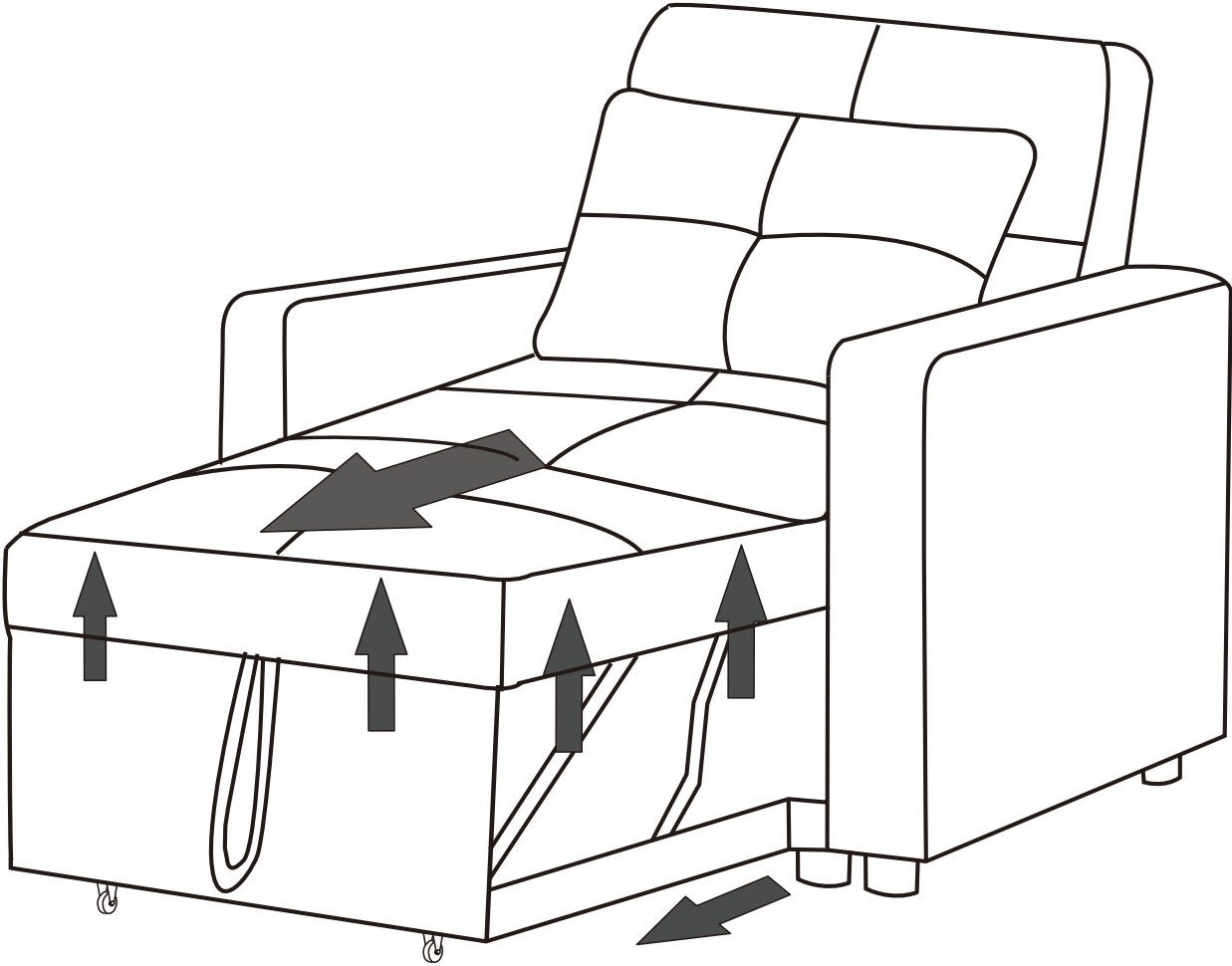

Pull forward then  
pull up

# Step 7

