



## **USER'S MANUAL** **Electric Standing Desk**

THIS INSTRUCTION BOOKLET CONTAINS **IMPORTANT** SAFETY INFORMATION. PLEASE READ AND KEEP FOR FUTURE REFERENCE.

---

---

## Product Technical Data

Item	Data
Input	AC100-240V,50/60Hz
Output	29VDC
Max Loading	176 lbs / 80 kg
Height Range(Without Desktop)	27.6"~47.3"/70CM~120CM
Working Ability	2 Min / 20 Min



## Cautions

1. Please read this manual before operating this equipment.

---

2. NOTE: Please use this equipment according to the instructions in this brochure to avoid accidents.

---

3. Keep children and pets away from the electric height-adjustable desk during the operation. Unplug the power cord during a thunderstorm or if you do not intend to use the desk for a long time.

---

4. DO NOT sit or stand or lying on the desk.

---

5. DO NOT immerse in water. Keep away from liquid or heat sources.

---

6. DO NOT adjust the height continuously for more than 20 times in short time. Allow the product to rest for 10 minutes before re-using.

---

7. DO NOT put objects over 176 lbs on the desk.

---

8. Please DO NOT place anything under the table top when lower down the desk. Ensure no obstacles in the desk's path and no object above and 20" under the desk.

---

9. Make sure desktop not touching the wall.

---

10. Although the product comes with anti-collision function, in order to avoid any pinching, please ensure that hands or other parts of your body are in a safe position during the operation. Anti-collision will be closed during resets process.

---

11. Working environment temperature 0-40 °C, keep products away from extreme temperature, humidity environment, corrosive gas, liquid and dusty objects.

---

12. Please DO NOT disassemble or repair the equipment by uncertified personnel to avoid the failure or damage of product or electric shock to the human body.

---

13. It is necessary to reset manually after the initial installation or power off.

---

14. DO NOT use this equipment in case of failure!

---

15. Before checking or wiping this equipment, please cut off the power!

---

16. Please DO NOT use water or alcohol to clean the equipment!

---

17. The company does not bear any warranty or liability for damage and human injury caused by any abnormal operation.

# SPECIFICATIONS

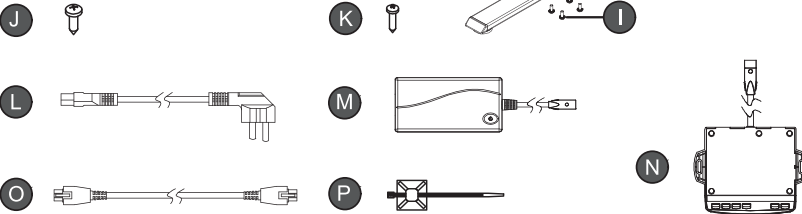
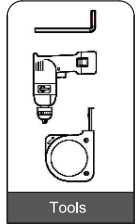
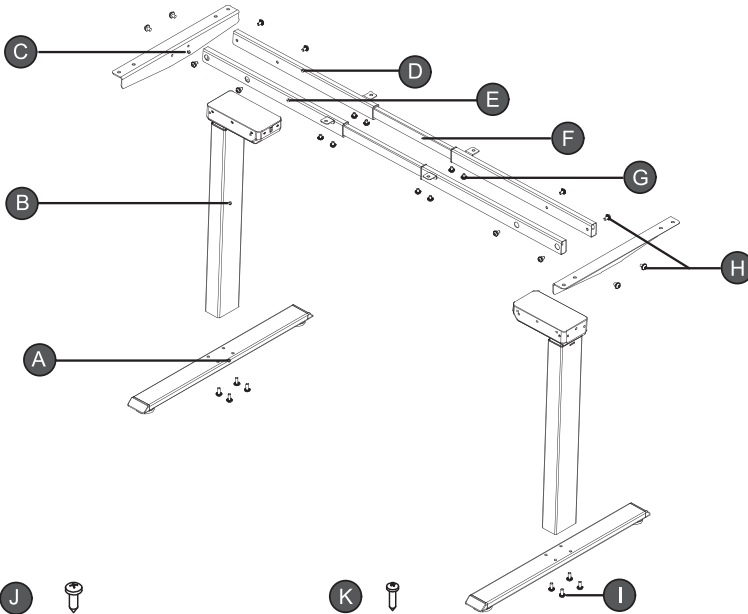

NO	Part name	Qty(PCS)
A	Foot	2
B	Column	2
C	Side Bracket	2
D	Right Tube	2
E	Left Tube	2
F	Extension Tube	2
G	M6*8 Bolt	10
H	M6*10 Bolt	14

NO	Part name	Qty(PCS)
I	M6*30 Bolt	10
J	ST4.8*13 Screw	18
K	ST2.9*15 Screw	4
L	Power Cord	1
M	Power Adapter	1
N	Control Box	1
O	Extension Cable	1
P	Cable Clip	6

# INSTALLATION INSTRUCTION

## STEP 1

- Set the right tube and left tube flat.
- Insert the extension tube to the right tube and left tube as is shown in the picture, pre-tightening the bolts.

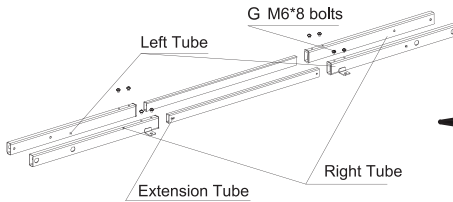

 Please check whether there is a lack of spare parts, and adjust the frame expansion tube to the appropriate length.

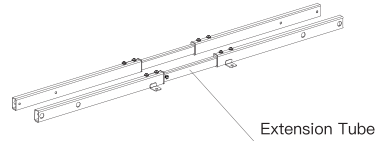

 Avoid excessive tightening bolts

## STEP 2

- Insert the columns into the place which is between the left and right tubes respectively, line up the holes on the frame and column.
- Pre-tighten the bolts.

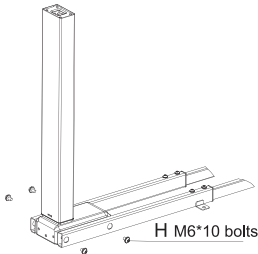

 Avoid excessive tightening bolts

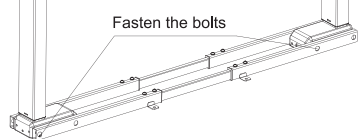

## STEP 3

- Mounting the side bracket on each side of the column.
- Fasten the screws.

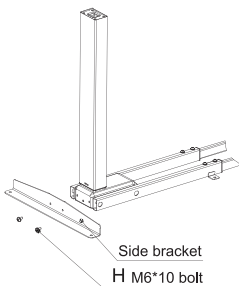

 Avoid excessive tightening screws

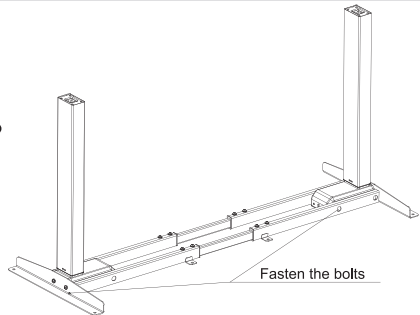

# INSTALLATION INSTRUCTION

## STEP 4

- Line up the screw holes on the feet and columns.
- Fasten the bolts.

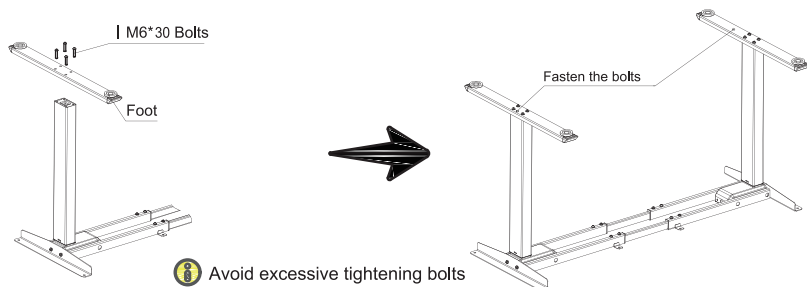

## STEP 5

- Check both sides of desktop before placing the base on the bottom side of the desktop.
- Adjust the suitable width. It is suggested that the two sides of the frame side brackets are 2~4inch/5cm~10cm from the edge of the desktop and fasten screws.
- As shown below,connect related parts, including control box,extension cable and power cord.
- Check all bolts and screws. Make sure all bolts and screws are tightened.

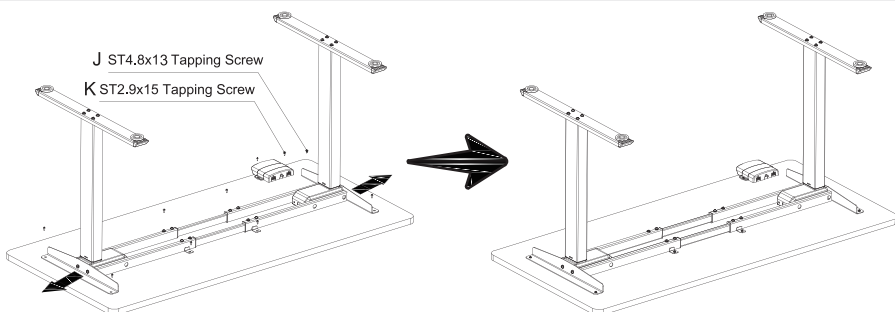

## STEP 6

- Insert the handset on suitable position of desktop edge to avoid interference with humans or chairs.
- Tidy up all the power cables, and fasten with cable clip.

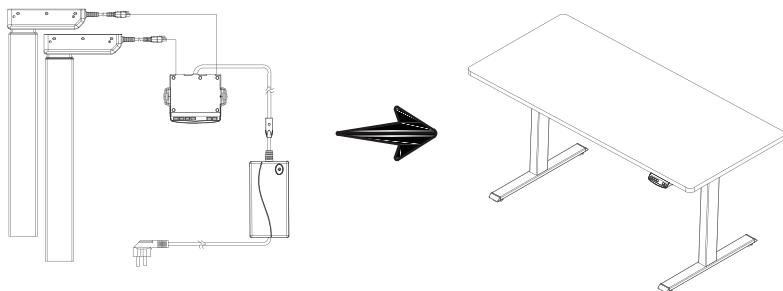

# INSTALLATION INSTRUCTION

## STEP 7

·The hook is installed on the table as shown below.

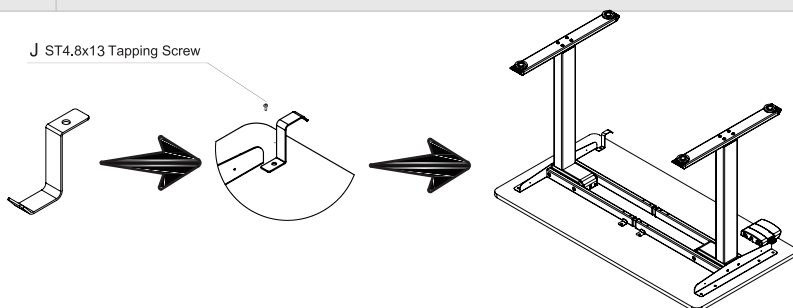

## STEP 8

·The shelf is installed on the table as shown below.

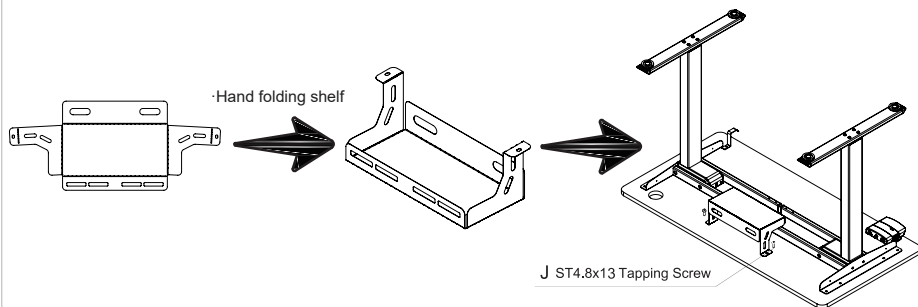





# USAGE INSTRUCTION





## • Manual Reset

 It is necessary to be reset manually after the initial installation and power off.





-   • Keep pressing down key until the display shows "E-1" and "rES" alternately and release the key.
-  • Keep pressing down key again, the desktop will move slowly down and return back till the display shows "70 (27.6") /60 (23.7")"
- Release the key, the height-adjustable desk resetting finished.

 **Note:** The anti-Collision function is not enabled during all resets. Please note that there is a potential risk of pinching in this case, and be sure no obstacles in the desk's path.

## • Up and Down

-  • Keep pressing "up" key till the required height is reached.
-  • Keeping pressing "down" key till the required height is reached.

## • Saving Position

-   • Adjust the desktop to the height you want to save
-  • Press "S" key, until the display will show "S --"
-  • Press "1", and the display will show alternately as "S-1" and the desktop height.
-  • Press "S" key, the first memory position is set successfully. Similar progress for 2 and 3 memory positions.

# USAGE INSTRUCTION











## • Anti-Collision Function

 Before use, please make sure removing obstacle in advance and human body is in the safe position.

1.  • Once the desktop encounters any obstacle in its path, the screen displays "E-2"
  - The desktop will move a defined distance in opposite direction, and it would be used normally after removing the obstacle.







## • Movement Limit & Self-stop Positions

 Enable this function only when you are really need in some situation.

1.  • Keep pressing the key "S" for 3 seconds until the display shows "S--" to enter setup menu.
2.   • Press up key till the display flash as "HLP".
3.   • Press "1", the display will show alternately as "H-P" and current height.
4.   • Keep pressing up or down key till the required upper limit position is reached.
5.  • Press "S", the desktop height will be shown and the self-stop position has been set.
6.   • Press "2", the display will show alternately "L-P" and current height, keep pressing down key till the low limit position is reached, press S the Movement limit & self-stop position has been set.

 Note: This function would be used to limit the height movement of desk. Once it is set, the new upper or lower limitation position will be stored.







## • Change the Displayed Unit (cm / inch)

1.  • Keep pressing the key "S" until the display show "S--" to enter the setup menu.
2.   • Press up key until the display will show "Unt".
3.  • Press "1", and the display will show alternately as "Unt" and the desktop current height value by "cm".
4.  • Press "S" key to save the unit as cm.
5.  • Press "2", and the display will show alternately as "Unt" and the desktop current height value by "inch", press key "S" to save the unit as inch.

---

# USAGE INSTRUCTION



## • Amend the Desktop Height Displayed

1.  • Keep pressing key "S" till the display show "A--" .
2.   • Briefly Press "Up" or "Down" key, until the display shows alternately as "End" and current height. (At this point, the units display mm or inch).
3.   • Press "1", "2", "3" to choose the first, second and the third number, each click will increase one value.  

4.  • Press "S" , the amending has been set.

 Note: The function enables you to change the height shows on the display based on the actual measurement.

## • Plug Detection

 The function can detect whether the motors are connected properly.

1.   • Once the display shows "E-3" and "rES", it means the motors are failed to connected with control unit.
2. • Please unplug the main cable, check all connection and make sure all cables are connected properly, plug the main cable then.
3.  • Follow the Manual Reset Progress to reset system.

## • Reset to Factory Setting

 With this function, you can make the control unit to factory setting.

1.  • Keep pressing "S" until the display shows "FAC".
2. • Press "S" again to confirm to store the control system to factory setting.

---

## CODE MEANING & TROUBLE SHOOTING

Code	Information	Operating
rES	Manual Resetting	Refer to the progress of Manual Reset.
ovr	Over Load	Remove the load on desktop until it less than 800N (176 lbs) before further operation
E-2	Anti-Collision Function	It can be used normally after removing the obstacle.
dut	Too Frequent Operation	Make the desk rest for 15minutes before further operation.
E-4	The Height Difference between Two Legs Exceed 1 Inch	Stop the operation and reset, refer to Manual reset
E-3	Check the Connection	Check the cables and ensure they are well connected, manual reset before re-use.