

60'

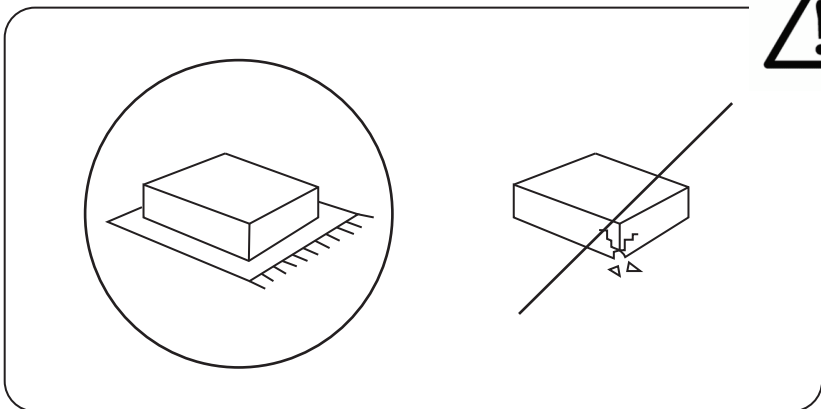

2

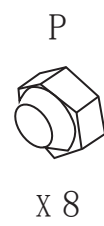
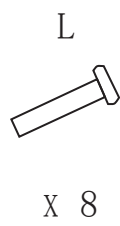
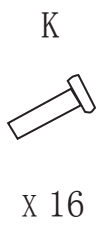
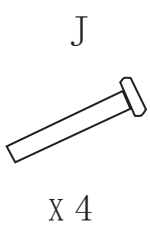
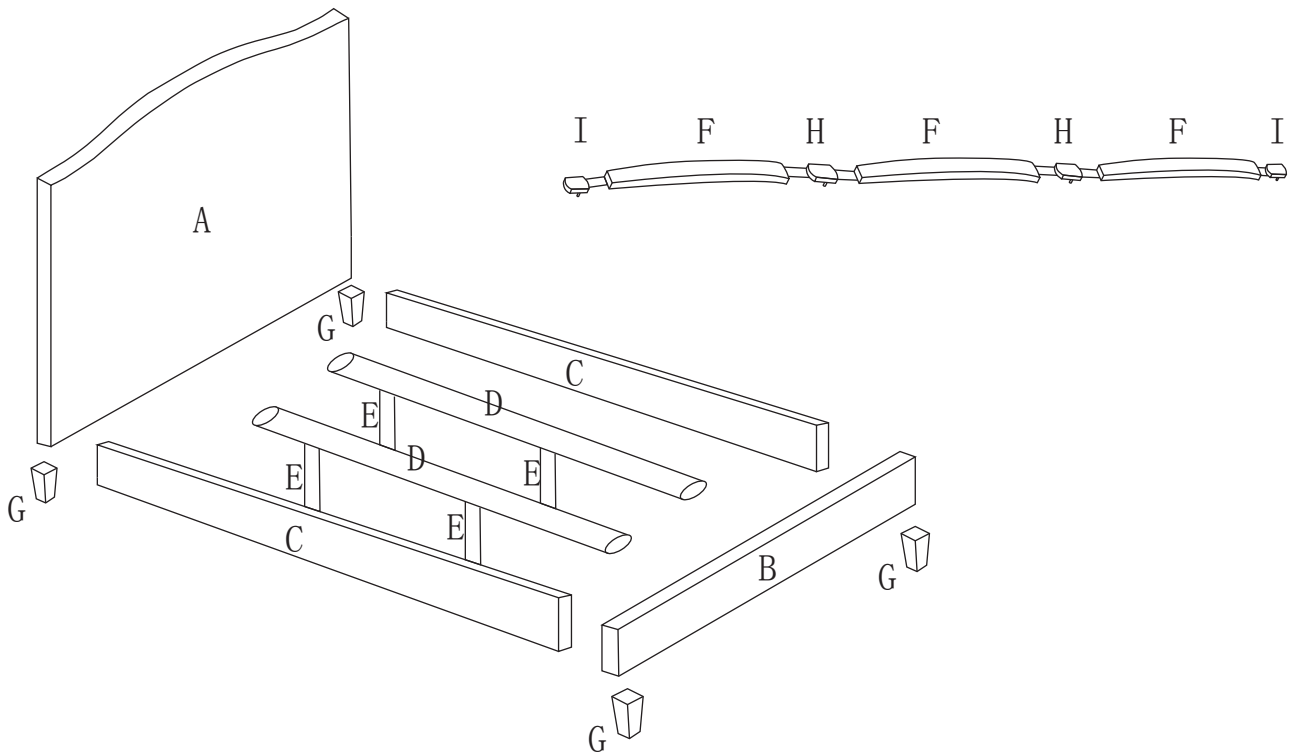
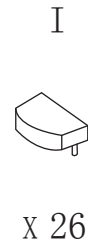
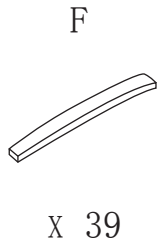
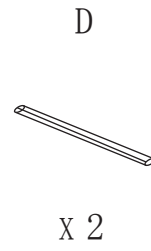
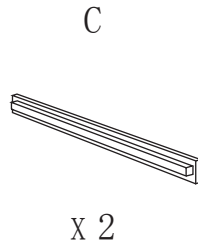
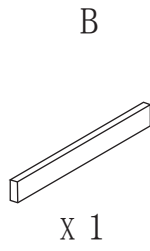
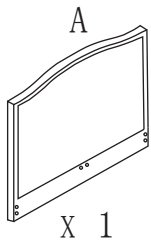

1

 Ax1  Bx1  G x4  O x4  Jx4  M x1

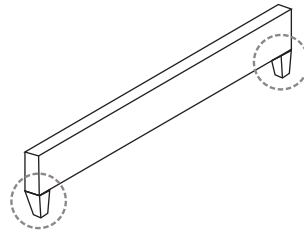
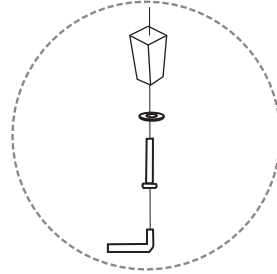
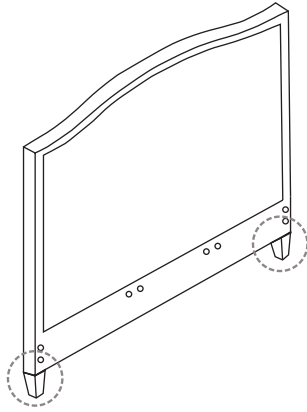

2

 Dx2  Ex4  Lx8  Px8  M x1
 Q x1

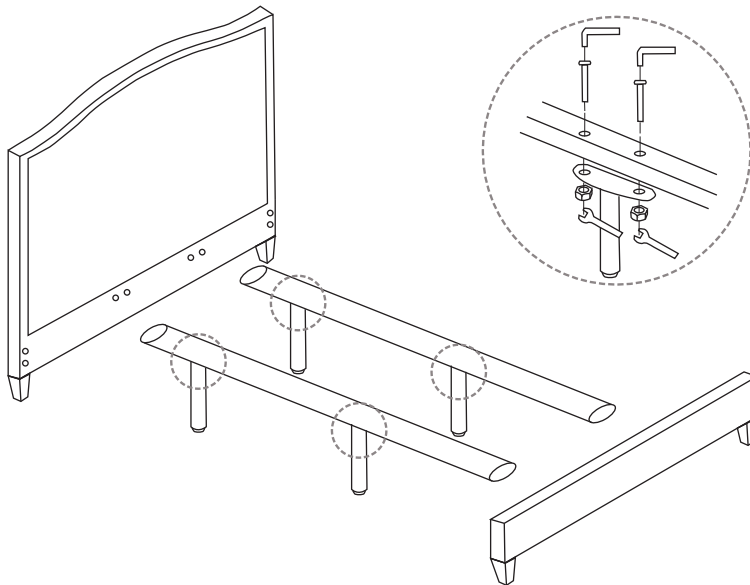

3

 K x8

 M x1

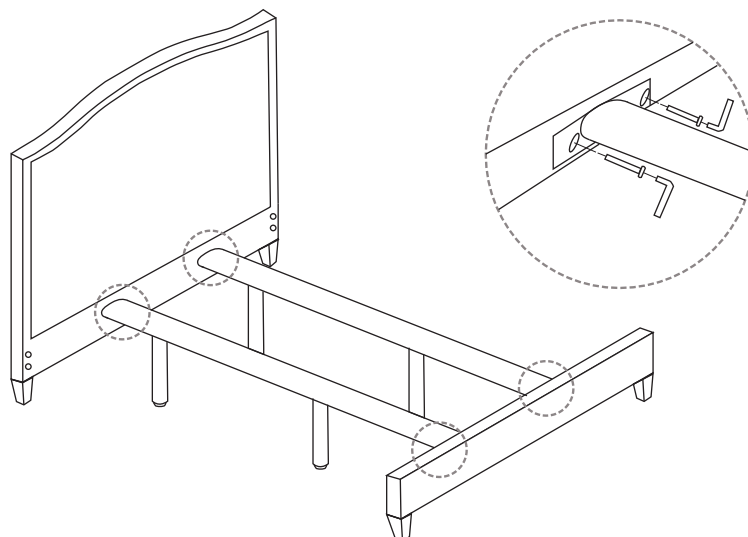

4

 C x2

 O x8

 N x8

 K x8

 M x1

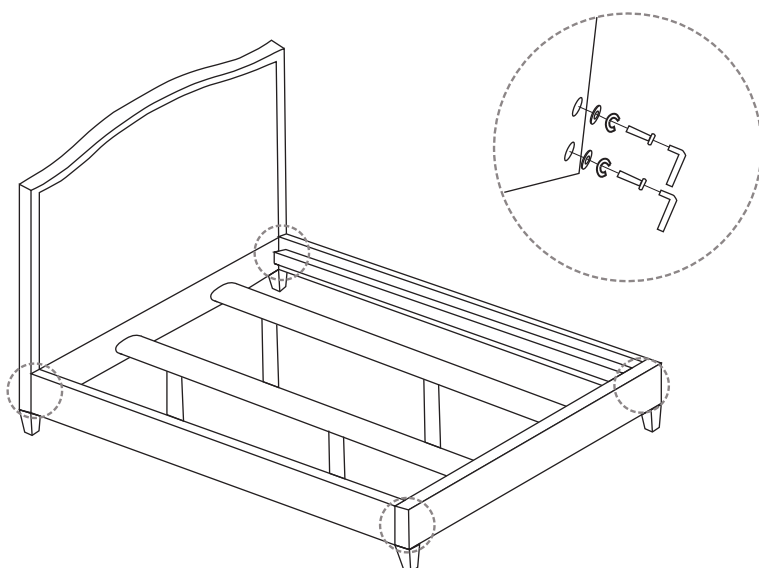

5

 Fx39

 Hx26

 I x26

