

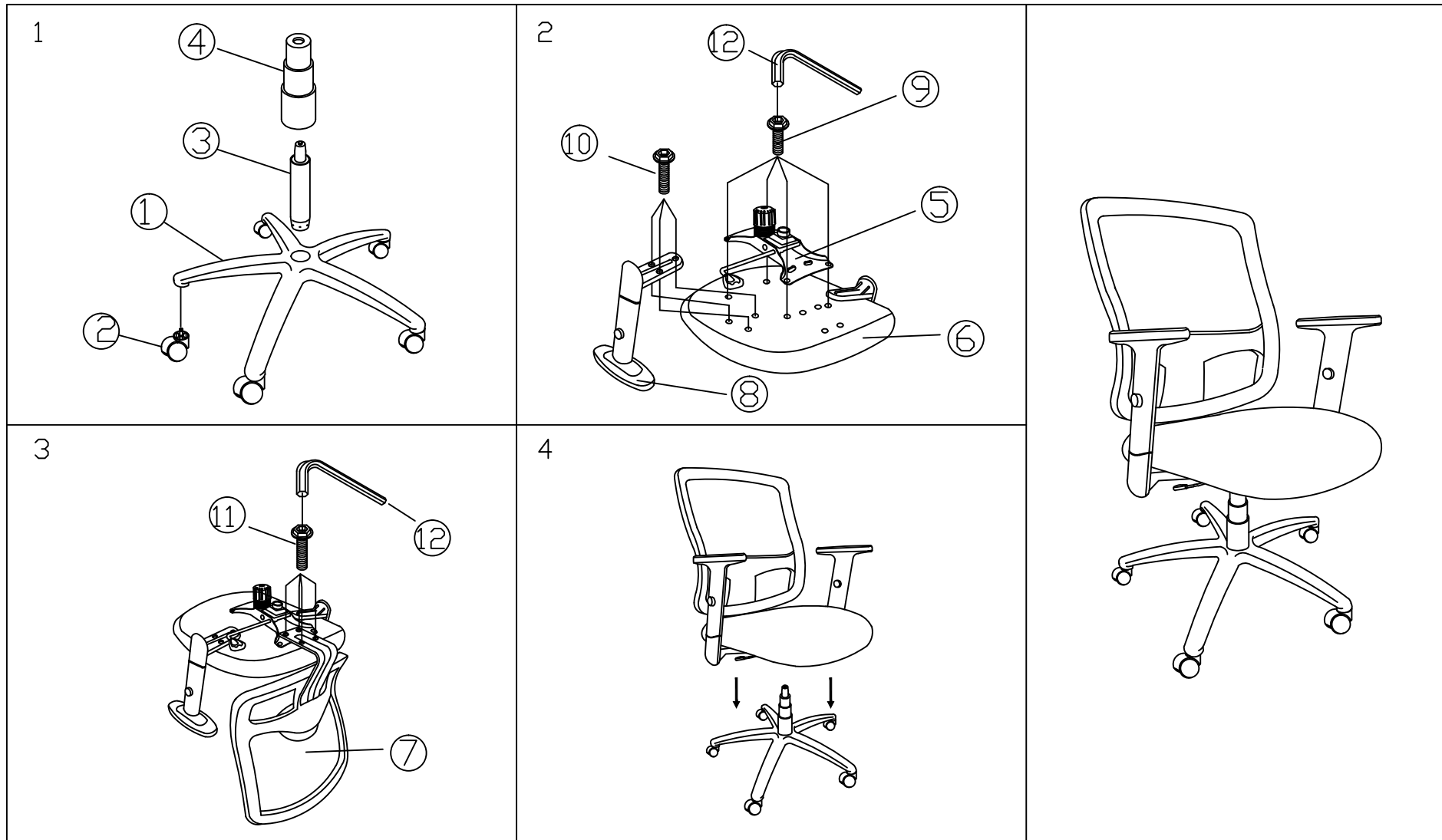









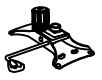

# ASSEMBLY INSTRUCTION



① 5-STAR BASE	② CASTOR	③ GAS LIFT	④ DUST COVER	⑤ MECHANISM	⑥ SEAT CUSHION	⑦ BACK CUSHION	⑧ ARMREST	⑨ SCREW M6*25	⑩ SCREW M6*40	⑪ SCREW M6*35	⑫ ALLEN KEY
											
1 PC	5 PCS	1 PC	1 PC	1 PC	1 PC	1 PC	1 PAIR	4 PCS	6 PCS	4 PCS	1 PC

IMPORTANT NOTE - PLEASE ASSES ALL COMPONENTS PRIOR TO DISPOSAL OF PACKAGING AND ASSEMBLY OF CHAIR