

Minimalist Bamboo Wood Double Bowl Feeder Installation Instructions

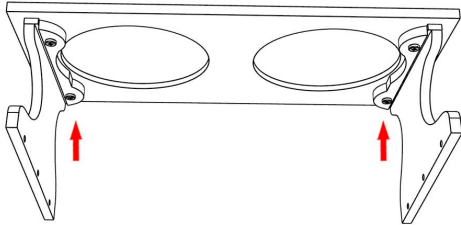

Step 1

Take the top panel, left leg, and right leg. Align the top panel with both legs as shown. Ensure correct orientation: the right leg aligns with the side that has the notch facing upward on the top panel. Use 4 M4x16 flat head screws to secure the top panel to the legs.

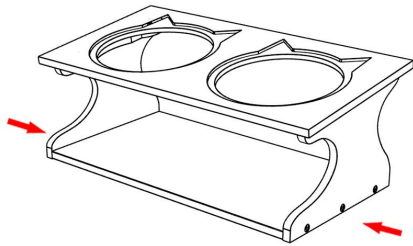
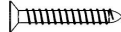





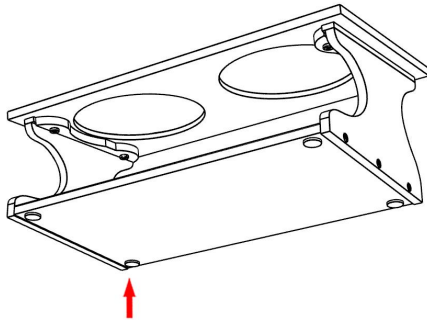



Step 2

Take the bottom panel and align it with the inner sides of both legs as shown. Use 6 M4x25 round head screws to secure the bottom panel in place.

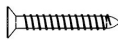

Step 3

Stick the non-slip pads on the four corners of the bottom side of the base.

	Top Panel x 1 PC
	Left Leg x 1 PC
	Right Leg x 1 PC
	Bottom Panel x 1 PC
	Ceramic Bowls x 2 PCS
	M4x16 Flat Head Self-Tapping Screws x 4 PCS
	M4x25 Round Head Self-Tapping Screws x 6 PCS
	Non-Slip Pads x 4 PCS

Parts List

Step 4

Place the ceramic bowls into the holes on the top panel. Installation complete.

