

## WARNING

WE RECOMMEND INSTALLATION OF THIS LIGHTING FIXTURE BE DONE BY A LICENSED ELECTRICIAN.  
WARNING \*\*\* SWITCH OFF THE MAIN ELECTRICAL SUPPLY FROM THE MAIN FUSE BOX/CIRCUIT BREAKER BEFORE INSTALLATION.  
INSPECT ITEM CAREFULLY BEFORE ATTEMPTING TO INSTALL. IF THERE IS ANY DAMAGE OR OBVIOUS DEFECT, DO NOT INSTALL. ITEM MAY NOT BE RETURNED ONCE IT HAS BEEN INSTALLED.

## CARE AND MAINTENANCE

To clean the outside of the fixture, use a dry or slightly dampened clean cloth (use clean water, never a solvent) to wipe the surface of the fixture.







To clean the inside of the fixture, first disconnect power to the fixture by turning off the circuit breaker or by removing the fuse at the fuse box. Next, use a dry or slightly dampened clean cloth (use clean water, never a solvent) to wipe the interior surface of the fixture.

Do not use any cleaners with chemical, solvents or harsh abrasives. Use only a dry soft cloth to dust or wipe carefully.

## NOTICE & IMPORTANT SAFETY INSTRUCTIONS

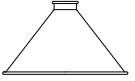
- \* Please make sure that you have all parts indicated before you begin assembly of this item
- \* This item should be assembled on a soft surface to prevent scratching the finish during assembly
- \* To reduce the risk of fire, electrical shock or injury to persons or property, please follow the guideline below for safe use and installation
- \* The external flexible cable or cord of this lamp cannot be replaced  
If the cord is damaged, the lamp shall be destroyed

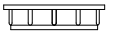
## Part List and Hardware List

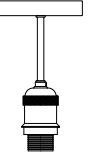
PIECE	DESCRIPTION	PICTURE	QUANTITY	PIECE	DESCRIPTION	PICTURE	QUANTITY
A	mounting bracket		1X	F	ball nut		2X
B	ground screw		1X	G	metal shade		1X
C	machine screw		2X	H	out ring		1X
D	wire connector		3X	I	bulb		1X
E	canopy unit		1X				

Product Dimensions: 11"D\*11 3/4"H

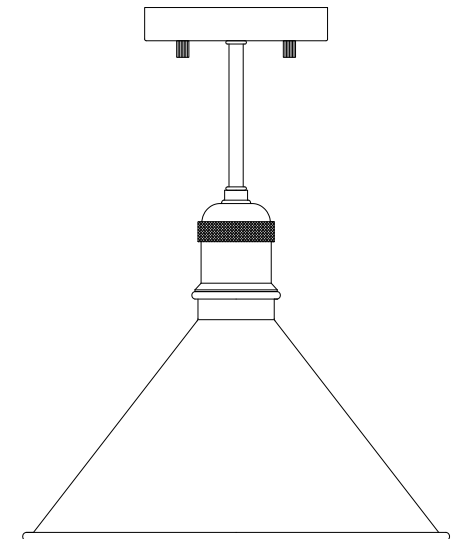

## PREPARATION

Before beginning assembly of product, make sure all parts are present. Compare parts with package contents list and hardware contents list. If any part is missing or damaged, do not attempt to assemble the product.

Estimated Assembly Time: 20 minutes.

1. Attach the mounting bracket (A) to the junction box with machine screw (C).
2. Connect the wire with wire connector (D).

Connect, Hot, Black or Red Outlet Supply Wire to:	Connect, Neutral, White Outlet Supply Wire to:
Black	White
* Parallel Cord (round & smooth)	* Parallel Cord (square & ridged)
Clear, Brown, Gold or Black without Tracer (colored stripes)	Clear, Brown, Gold or Black with Tracer (colored stripes)
Insulated Wire (not green) with copper metal conductor	Insulated Wire (not green) with Silver metal conductor.

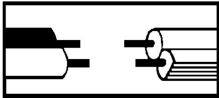

\*Note: When parallel wire ( SPT I & SPT II ) is used. The neutral wire is square shaped and ridged and the hot wire will be round in shape and smooth. ( See Illustration on left. )

### Grounding Instructions:

- a) For installation in the United States: Wrap ground wire from outlet box around green ground screw(B) on mounting bracket, no less than 2" from wire end. Tighten ground screw. If fixture is supplied with a ground wire, connect to outlet ground wire with a wire connector.
- b) For installation in Canada: If fixture is supplied with ground wire, wrap ground wire around green grounding screw on mounting bracket. Tighten ground screw.

3. Thread the mounting bracket (A) through the canopy unit (E), secure with ball nut (F).
4. Attach the metal shade (G) to the socket with out ring (H).
5. Place the bulb (I) to the socket.

**PLEASE USE ON/OFF TYPE "B" BULB MAX 40-WATT OR CFL BULB MAX 9-WATT  
THERE ARE 4PCS TYPE "B" 25-WATT BULB IN THE BOX**

**ENJOY YOUR LAMP**

