





1. Thank you for choosing *our products*.

If you find that parts of your order are missing or damaged, we will gladly ship any needed replacement parts free of charge.

If your product's quality does not meet your expectations or you have found any sort of defect, please contact our customer service department and let us know the details of your order and any issues encountered, we will try our best to provide you with a solution. Feel free to also directly contact our manufacturer concerning needed replacement parts and they will be happy to help provide you with a solution or answer any questions you may have.

Recommendations Before Beginning Assembly

-  • Read instructions, cover to cover
-  • Have 2-4 adults on hand for assembly depending on product size
-  • Do not assemble directly on flooring or carpet
-  • Assemble on a clean non-marring surface (example: packing foam)
-  • Save all packaging until finished











3. Assembly Notice:

- If you encounter any problems during assembly and find that you cannot continue, rest assured we will help you solve the situation as soon as possible. Simply keep all of the parts of the product stored in a safe place and contact us immediately so we may assist you further.
- Once you have opened your package, remove all inner hardware packages and take the parts out. One by one, Place the parts out neatly in front of you, then refer to the instructions to ensure no parts are missing. If any pieces are found missing, please carefully look in the box first, as the hardware packaging might have torn making the

hardware spill in the box.

- Some key parts of your product may be stored and hidden inside of other parts. Please open any zippered or hook & loop storage compartments to remove all parts. (example: cushions and legs being stored in the underside of a sofa)
- **IMPORTANT:** When setting up your product, **DO NOT INSTALL THE SCREWS ALL THE WAY IN THE BEGINNING.** Place each screw into their proper hole and use your hand to twist the screw halfway. Twist all the screws in halfway to ensure the holes will match up properly and the product is level on the ground. When everything seems fitted, then tighten the screws.
- When you have completed assembly, we suggest you have more than one person to assist you with lifting and placing the product.

Care & Maintenance









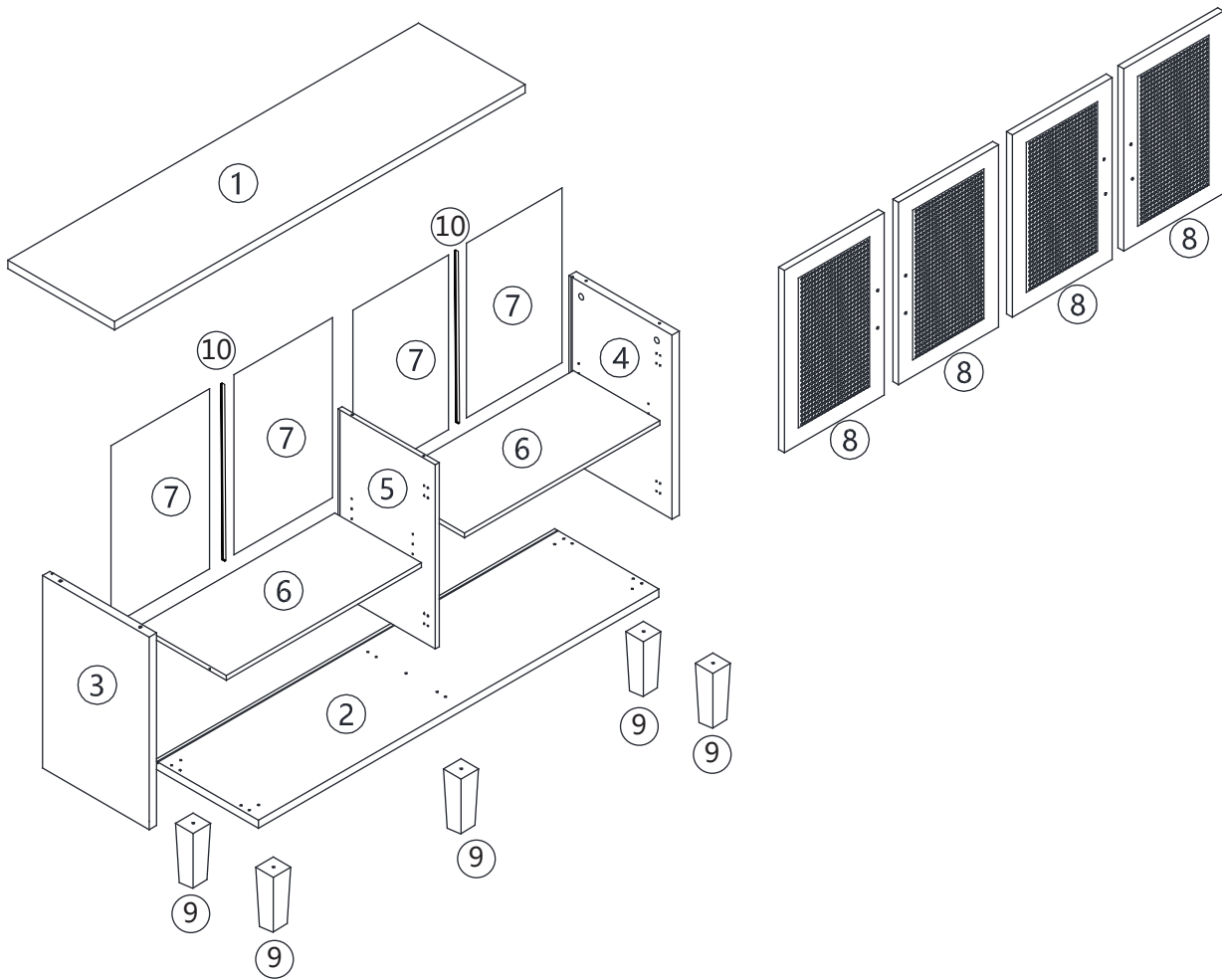
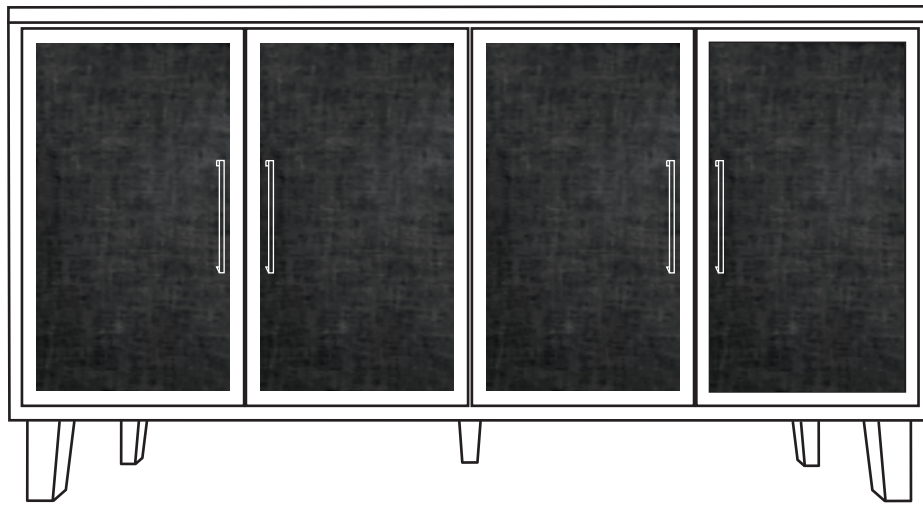





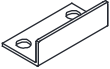

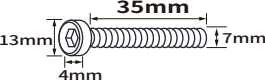
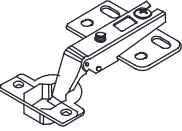
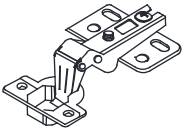

- ⊘  • Do not put hot items directly on furniture surface
- ⊘  • Do not clean furniture with harsh cleansers or polish
- ⊘  • Do not place furniture under direct sunlight
- ⊘  • Do not place furniture near heating or cooling vents
- ⊘  • Do not write on furniture without a padded barrier to protect the surface
- ⊘  • Do not place furniture outside. For indoor use only
- ⊘  • Not for commercial use. For residential use only
- ⊘  • Stains may be removed with mild soap solution and damp cloth
- ⊘  • Children should not climb or jump on the furniture
- ✓  • Dust and pick-up spills using a clean, non-colored, lint-free cloth

Caution

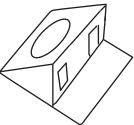
- This product contains small components. Please ensure that they are kept away from small children.
- Do not use power tools to assemble your furniture. Power tools may strip or damage the parts.



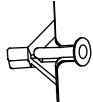



 Ø 6x35mm	 Ø 15x12mm	 Ø6x30mm	 Ø 5x60	
AX6	BX6	CX12	DX6	EX1
	 Ø3x14mm			 35mm 13mm 4mm 7mm
FX2	GX16	HX1	IX8	JX5
		 Ø4x16mm		
KX4	LX4	MX48	NX4	OX8
	 x2    			
PX12	QX2		RX4	

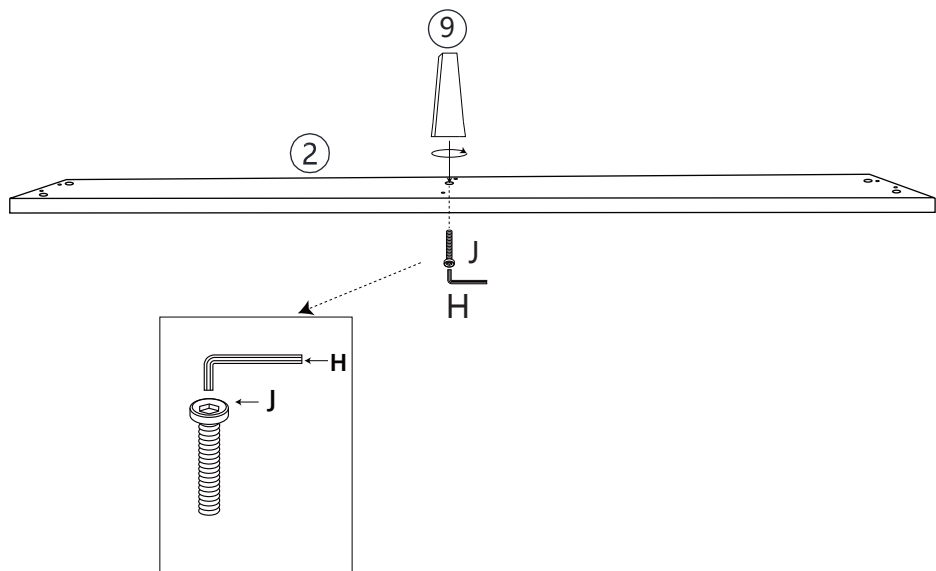

STEP 1



	
HX1	JX1

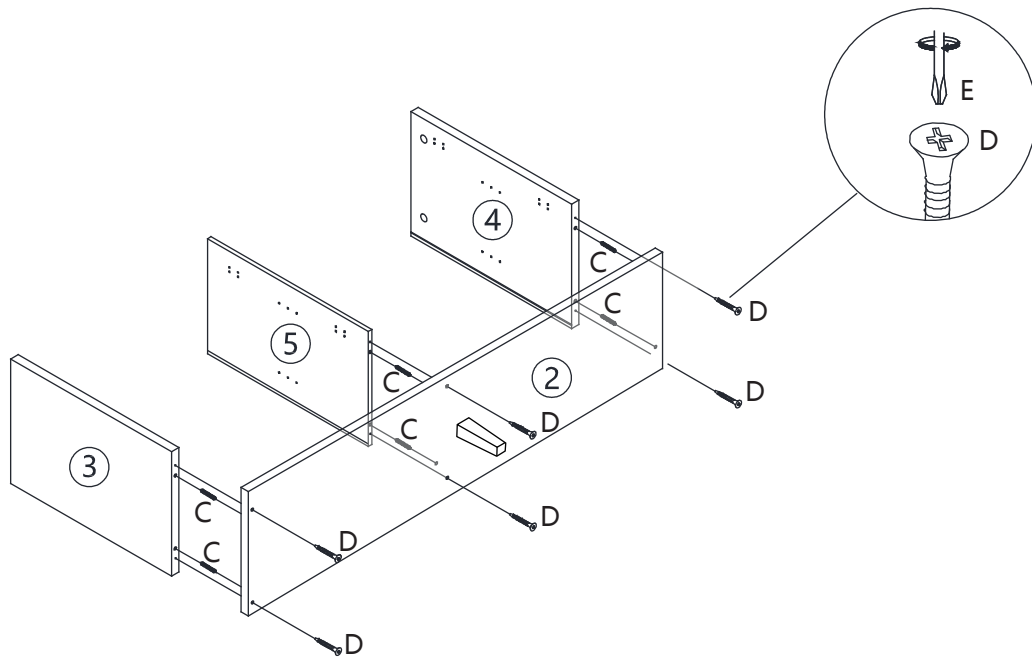

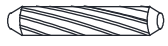
STEP 2

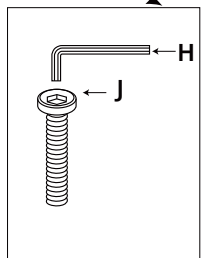
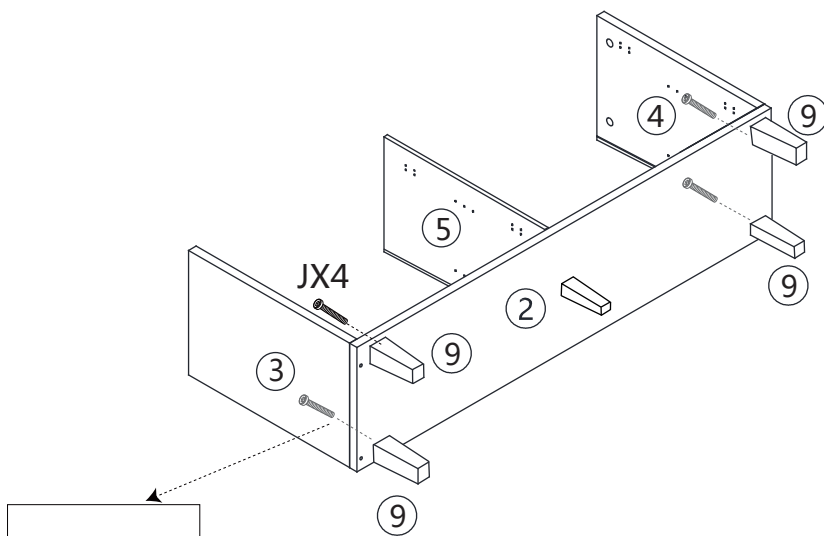

		
Ø6x30mm	Ø 5x60	
CX6	DX6	EX1

STEP 3







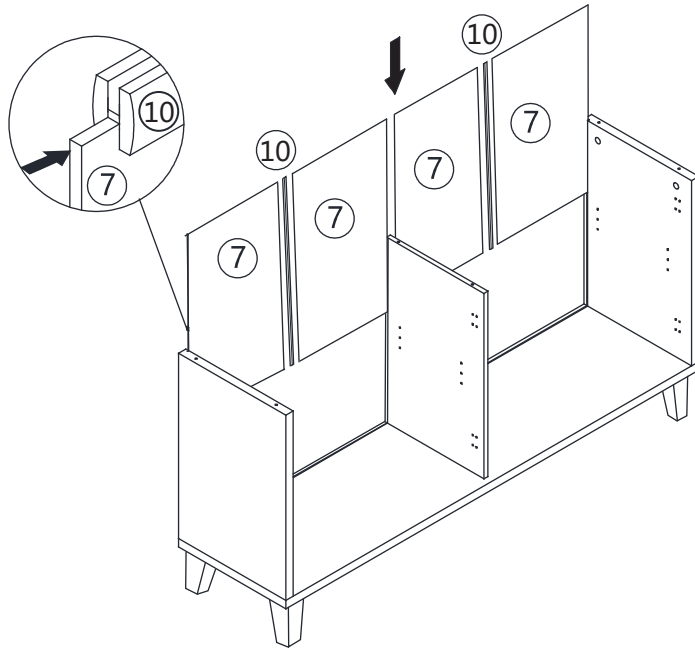

	
HX1	JX4

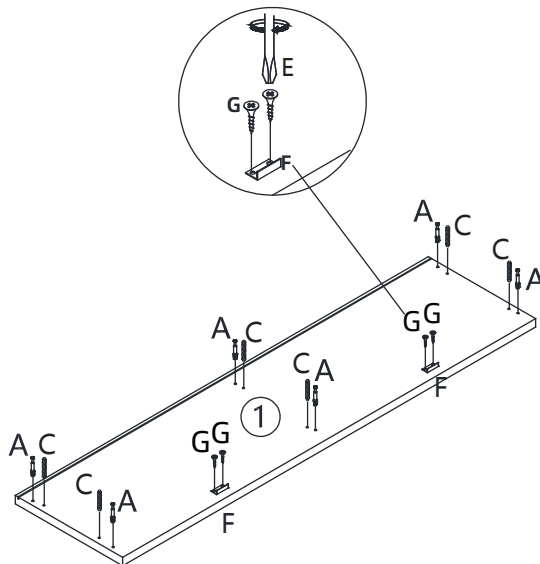
STEP 4



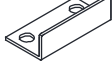

STEP 5

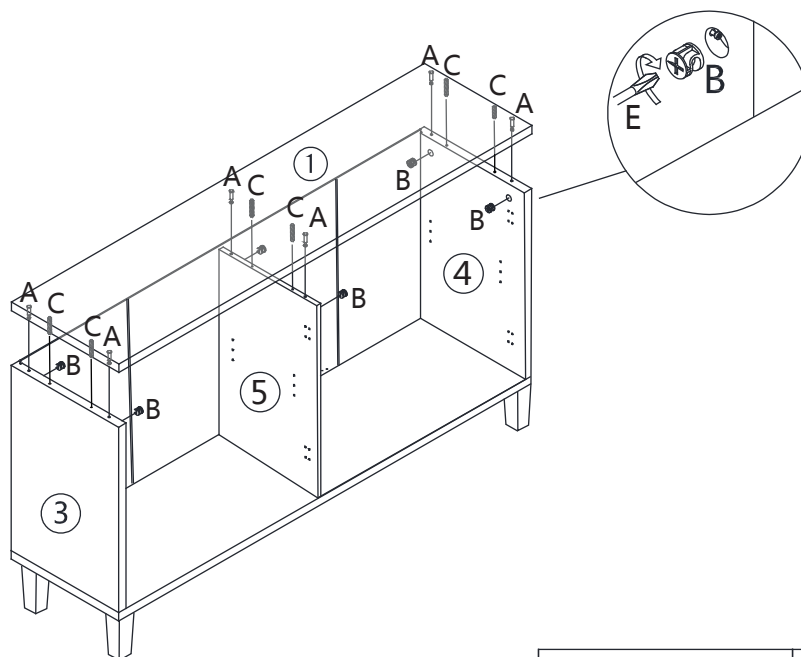

				
Ø 6x35mm	Ø6x30mm			Ø 3x14mm
AX6	CX6	EX1	FX2	GX4

STEP 6



	
Ø 15x12mm	
BX6	EX1



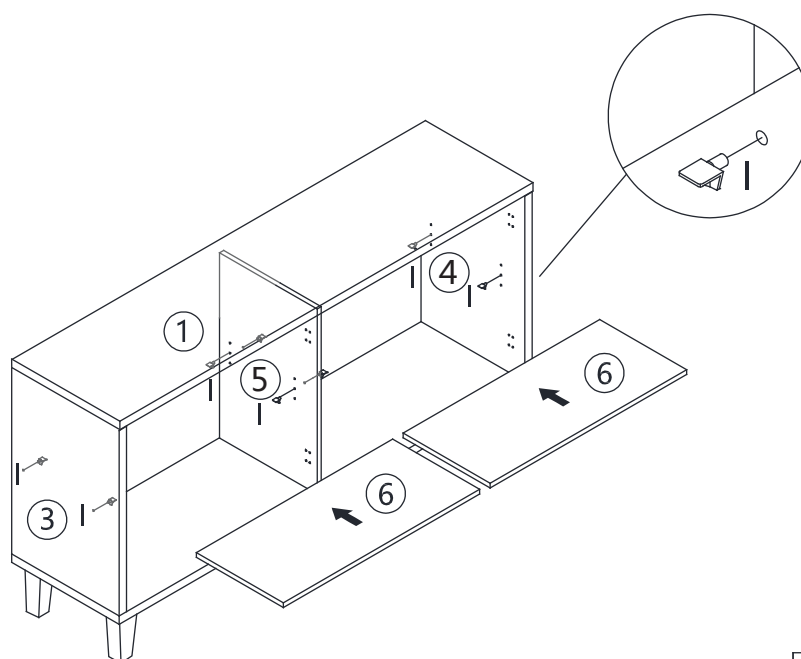

STEP 7



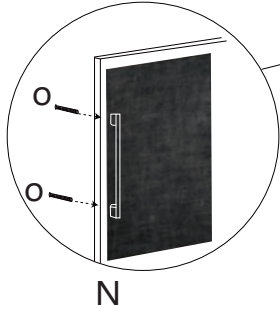
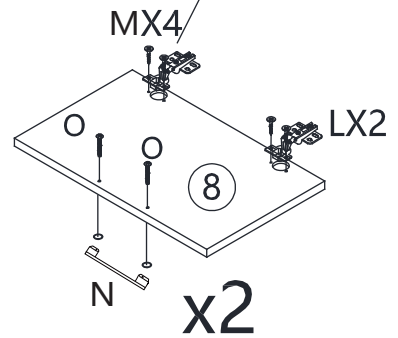
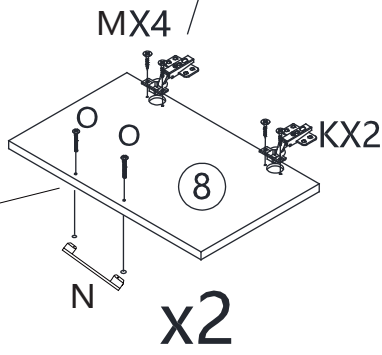
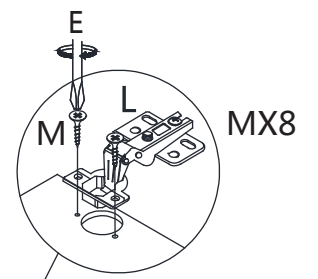
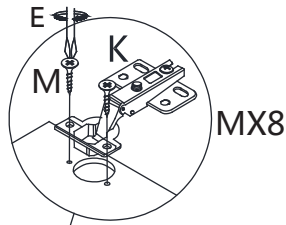

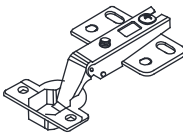
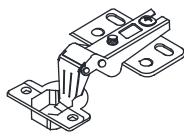
IX8



STEP 8

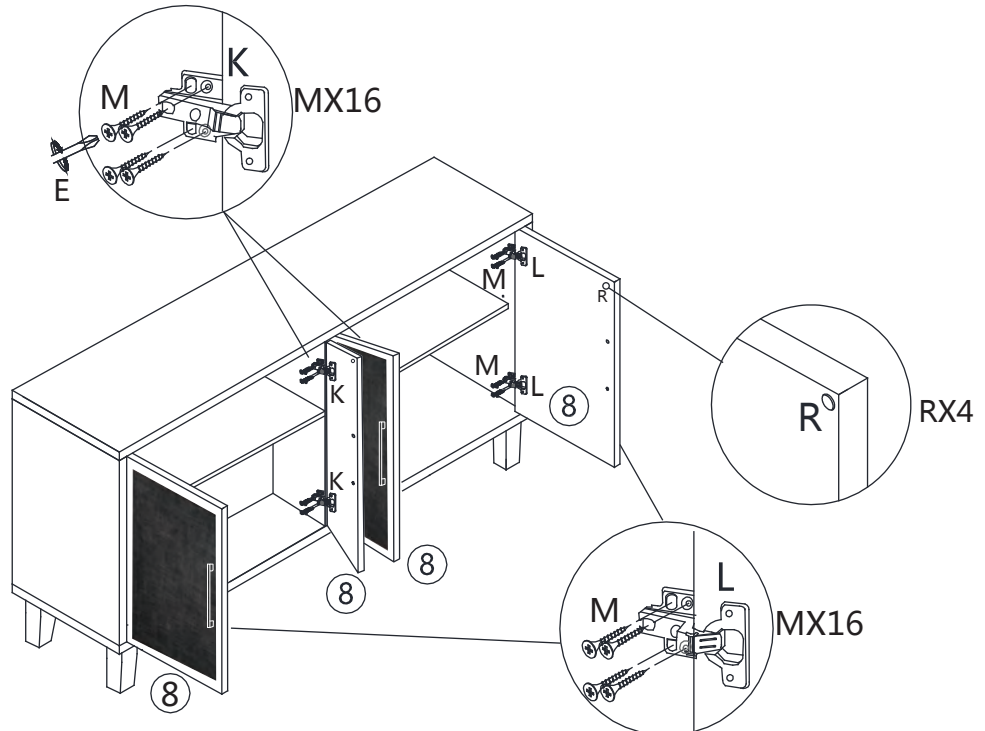

			 Ø 4 x 16 mm		
EX1	KX4	LX4	MX16	NX4	OX8







STEP 9

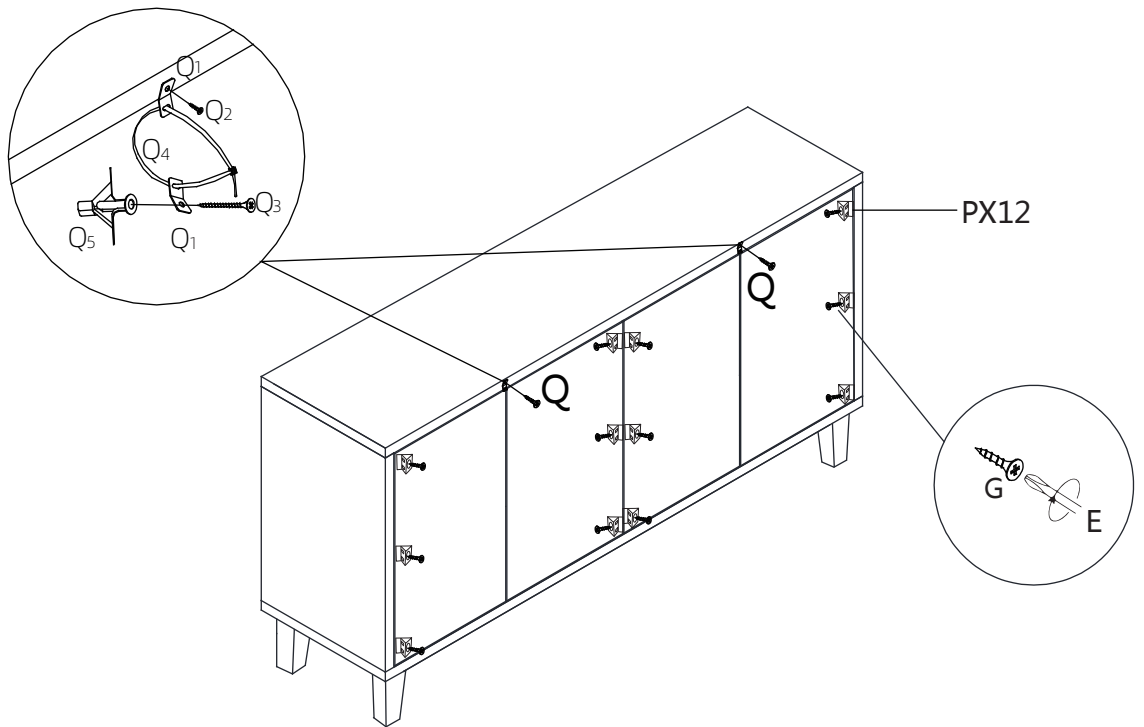

	 Ø 4 x 16 mm	
EX1	MX32	RX4

STEP 10

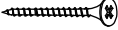
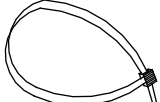

			 X2				
EX1	Ø3x14mm GX12	PX12	Q1	Q2	Q3	Q4	Q5
			QX2				

STEP 11

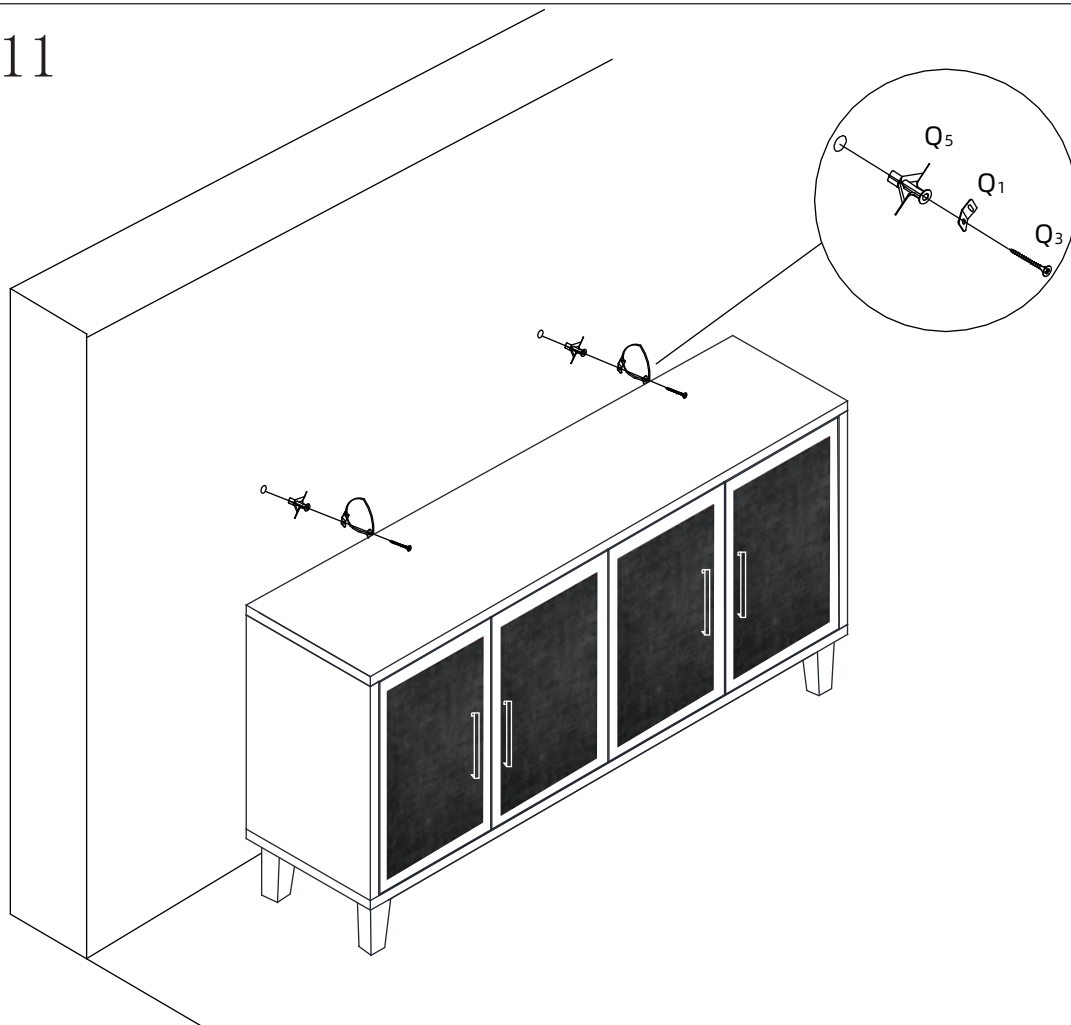

Assembly Steps(EN) / Montageschritte(DE)

HOW TO ADJUST THE HINGES TO ALIGN THE DOORS IF NEEDED.

STEP 1

Open the door.

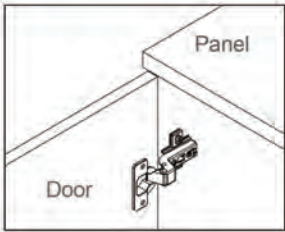

STEP 3

Adjust the flush between door panel and side panel

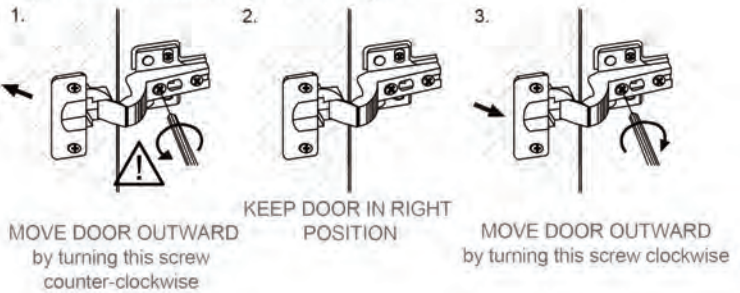

STEP 4

Adjust the Gap between door panel and side panel

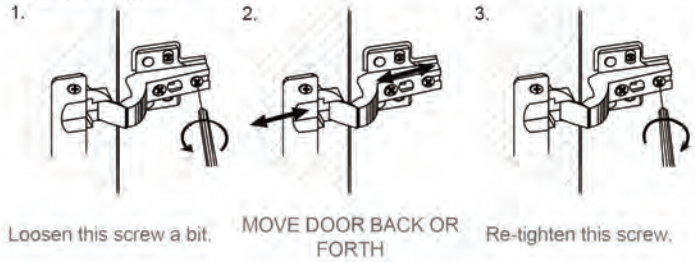

STEP 2

Adjust the door panels upward or downward

