

ASSEMBLY AND OPERATING INSTRUCTIONS



FOR MODEL:GHG-069-1012

Read Manual

Your ancient Pavilion Frame requires assembly prior to use. It is important that you read the entire manual to become familiar with the unit BEFORE you set up the Pavilion Frame.

Safety Warning and Precautions











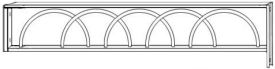

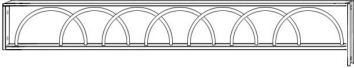







WARNING: When using product, basic safety precautions should always be followed to reduce the risk of personal injury and damage to equipment.

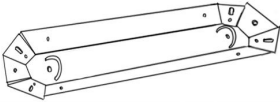

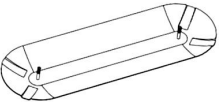

















Read all instructions before assembly and usage this product

- 1. Select ideal location.** Set out all parts on a clear and level surface prior to assembly. Ideally, the Pavilion Frame should be set up in the desired location to avoid moving it after assembly.
- 2. Use caution.** During all the processes of assembling, especially when lifting heavy or large parts, pay attention to safety.
- 3. Tools and Assistance.** Ladder and Phillips screwdriver are self-provided. Whenever possible, assistance is preferred.
- 4. Check for parts available.** Before assembling your Pavilion Frame, make sure that you have all parts described in the Parts List.
- 5. Check for damaged parts.** Before assembling your Pavilion Frame check for damaged parts. Any part that appears damaged should be carefully checked to determine if it can be operated properly and perform its intended function. Any part that is damaged should be properly repaired or replaced by a qualified technician.
- 6. Refer to assembly diagram.** During assembly, it will be helpful to refer to the assembly diagram.
- 7. Keep children away.** Children shouldn't be allowed in the work area. Do not let them handle parts and tools. No people should be permitted to enter into work area except who is working.

Note! This gazebo is meant to be used for Decorative and sunshade purposes only and is not meant to withstand all elements of the weather. Please remove all FABRIC during inclement weather.

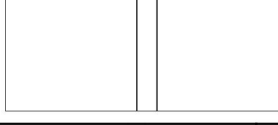
Parts List

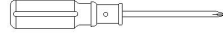
Parts#	Figure	Qty
A		4
A1		4
A2		4
A3		4
B		4
B1		4
B2		4
C		4
C1		4
Q		8
L		8
D		6
D1		4
D2		4
E		1
E1		2
F		1
G		4
I		6
J		8
J1		8
J2		16+1

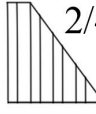
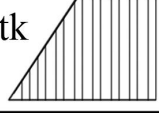
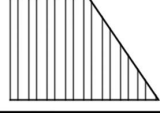
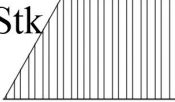
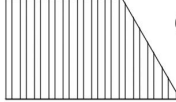
Parts#	Figure	Qty
K		4
M		6
N		4
O		88+2
H	M6×12 	16+1
H1	M6×12 	68+2
H2	M6×16   	8+1
H3	M6×15 	10+1
H4	M6×12  	18+1
H5	M6×32   	16+1
V		4
W		4
Y		8
S		1
Z		1
1/4Stk	  2/4Stk	9/6Stk
3/4Stk	  4/4Stk	
5/4Stk	  6/4Stk	

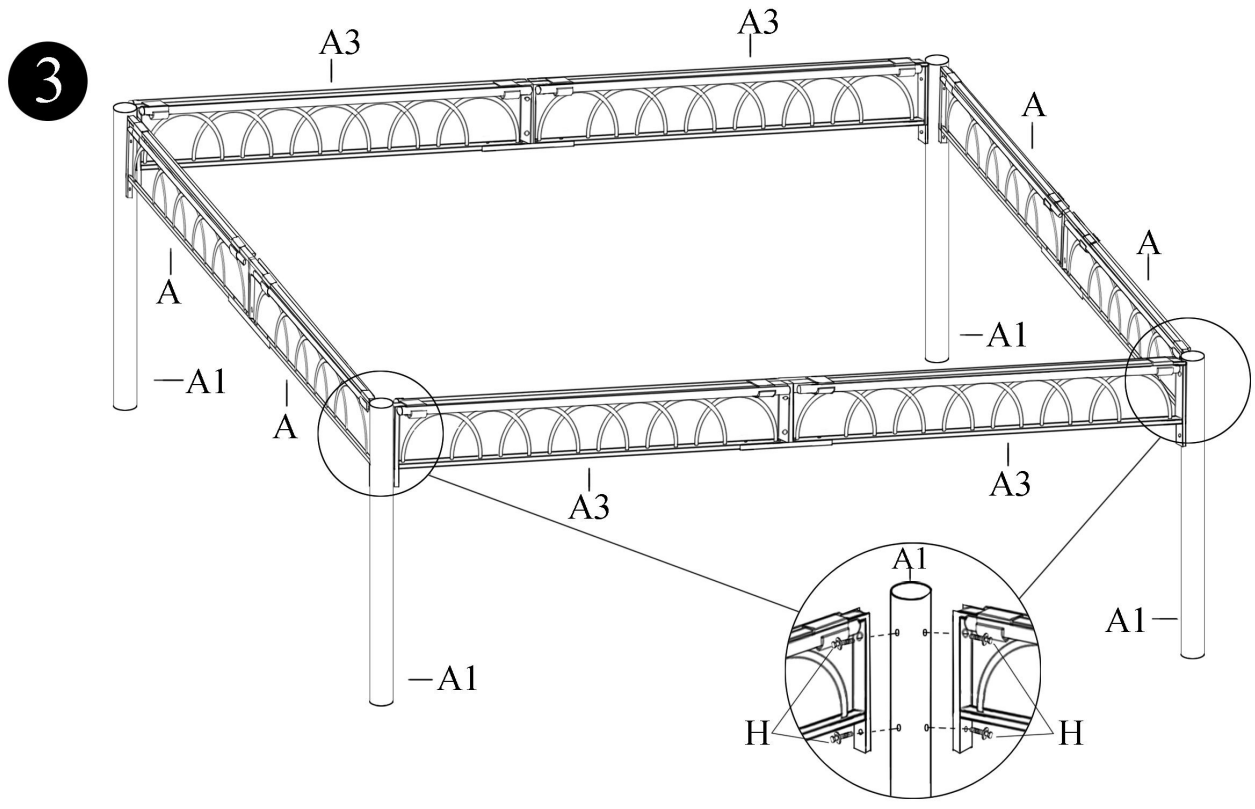
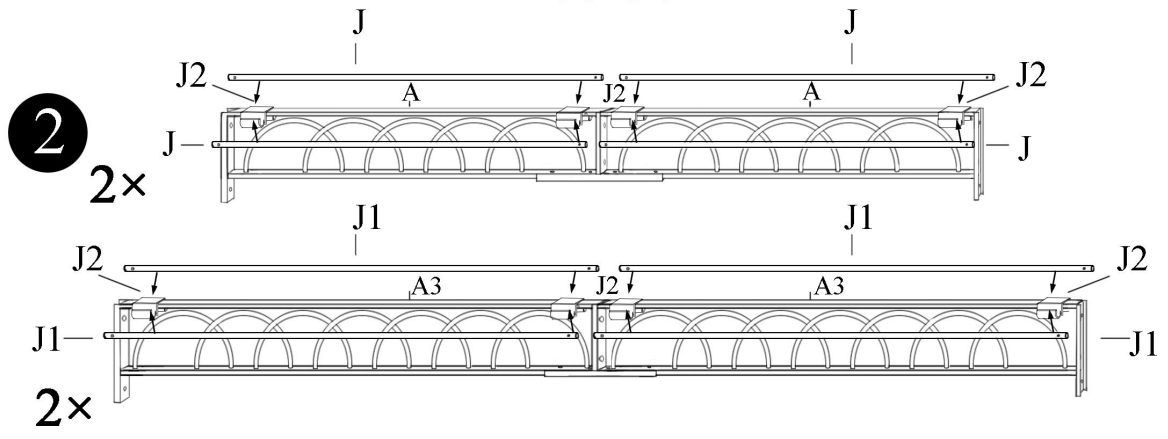
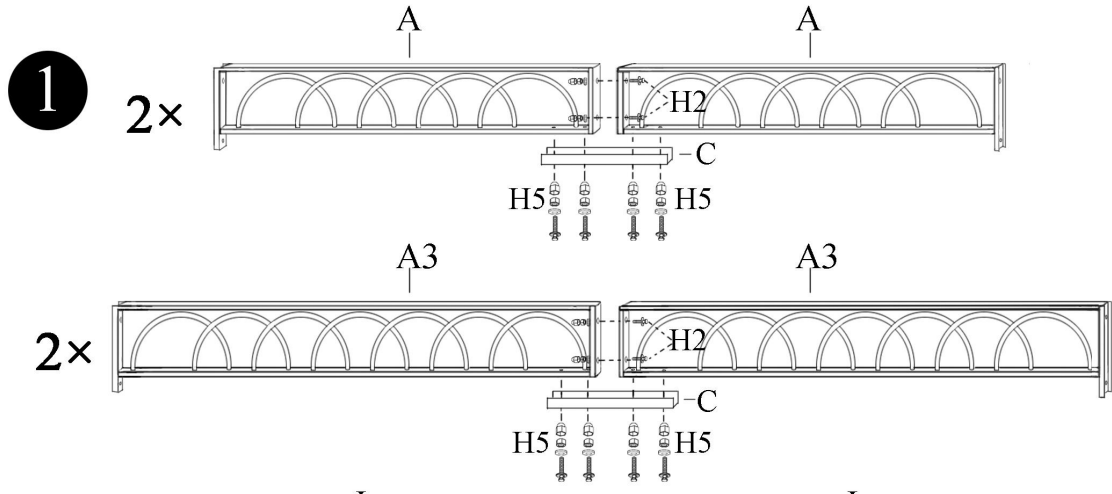

7

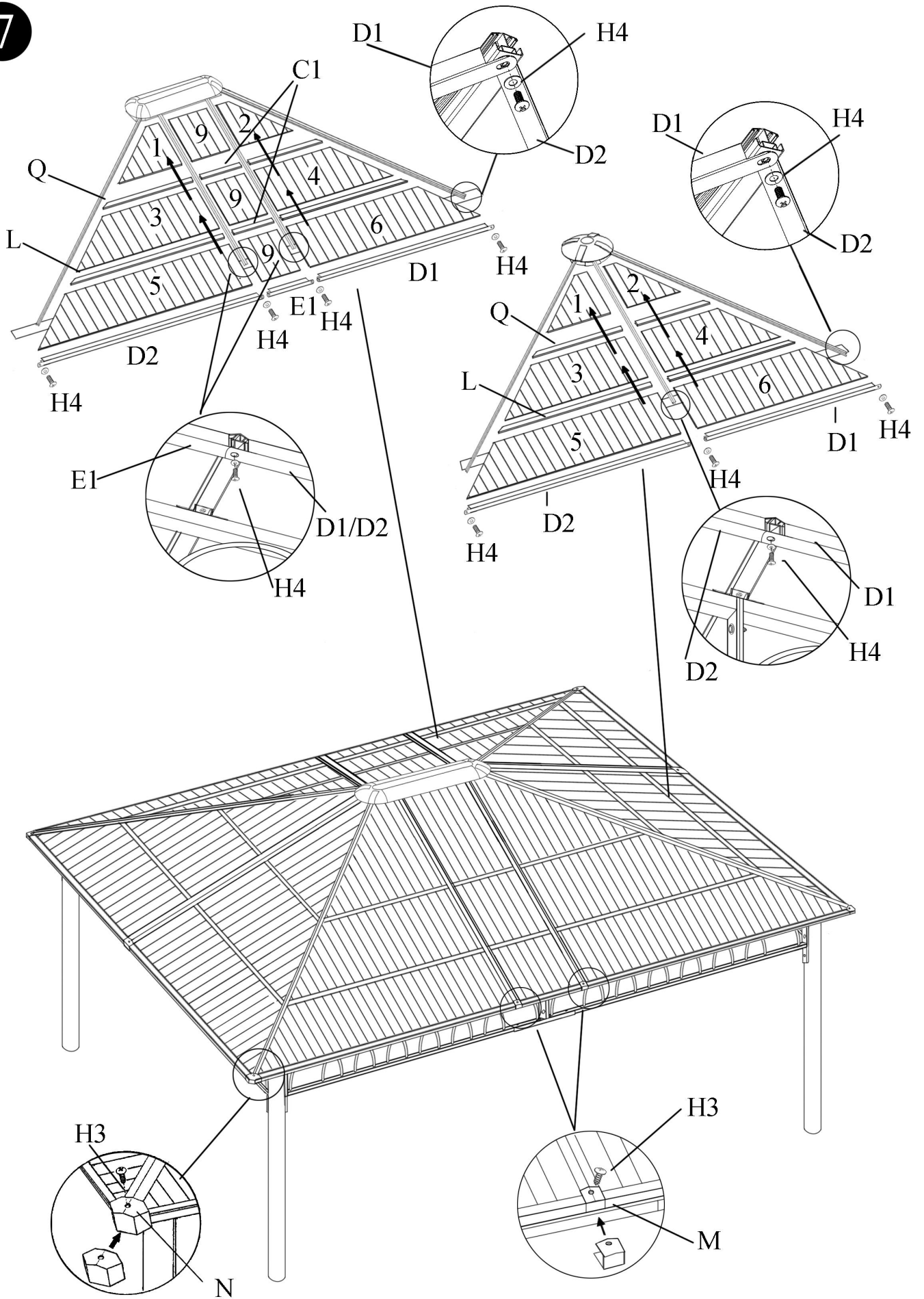

8

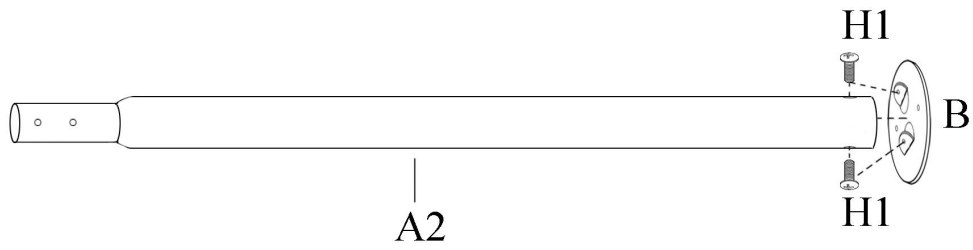

9

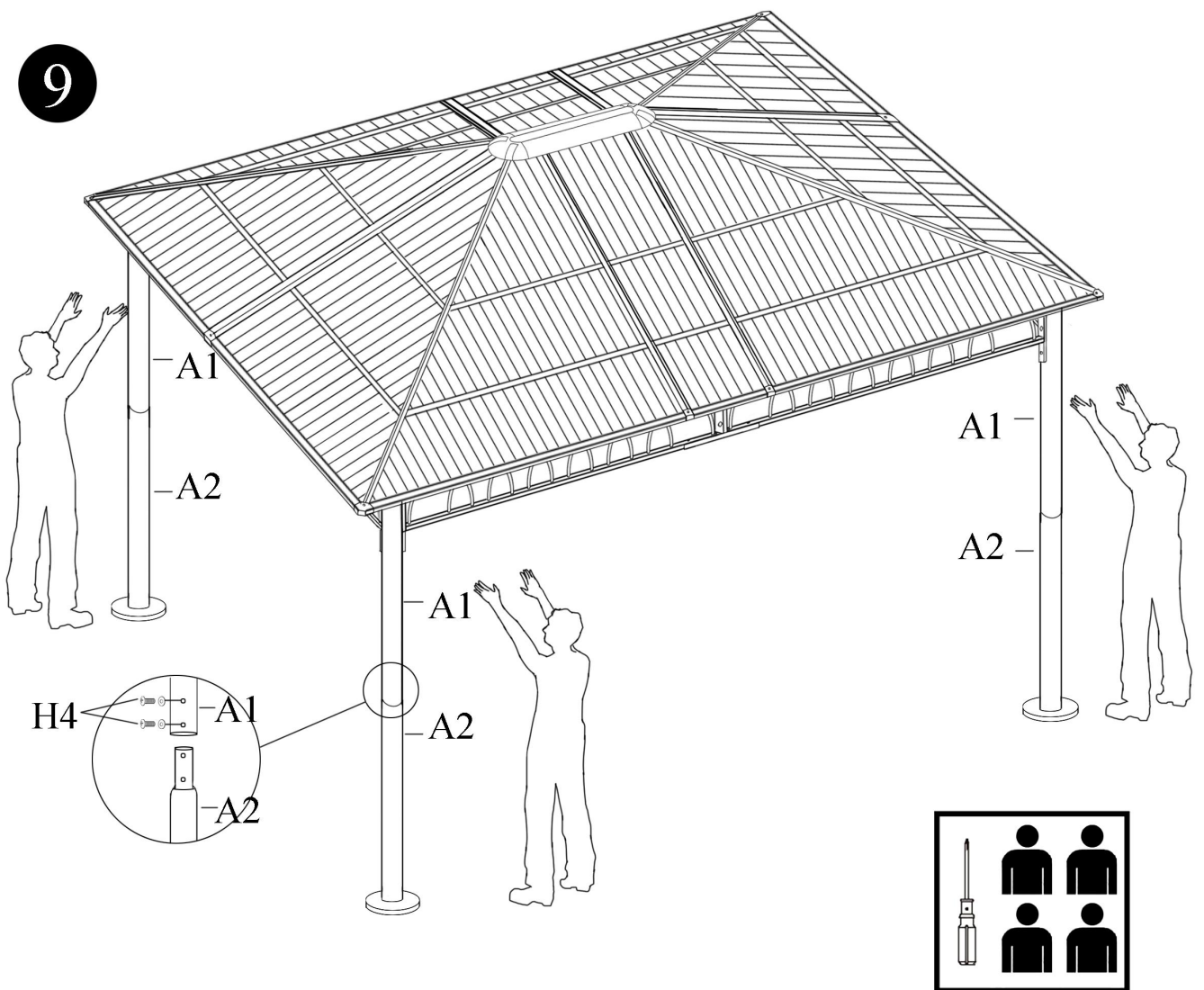

10

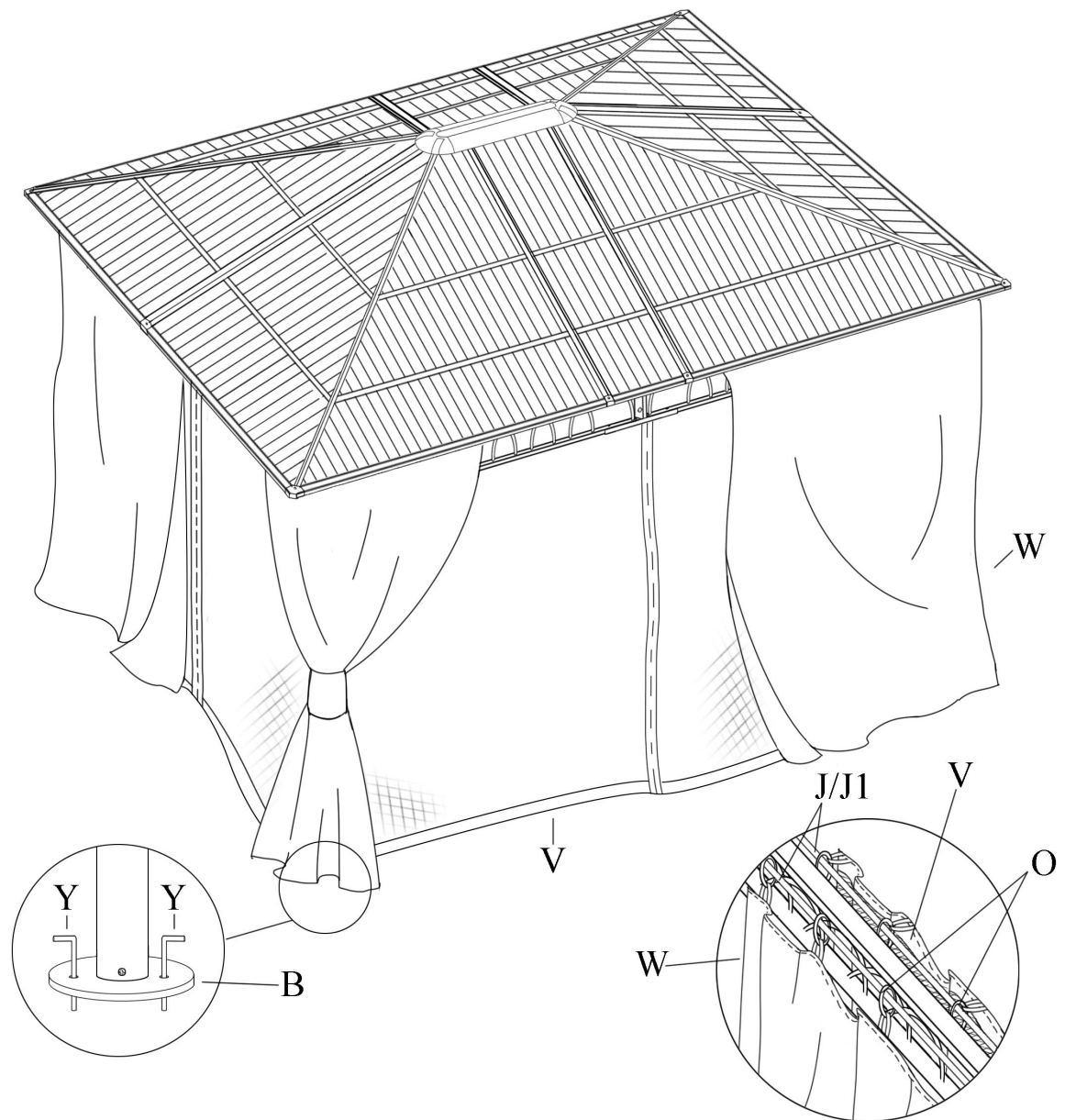

Please note:
For this Sun gazebo can take 10 cm of snow.
Please Sweep away the snow when more than 10cm.