

# SLAT KIT FULL BED

## ASSEMBLY INSTRUCTION

( FULL E-65303 )

Before assembling your bed slat kit, please read through these instructions carefully and familiarize yourself with the different parts. Please note that you will require a Phillips head screwdriver and an allen wrench.



### PARTS LIST

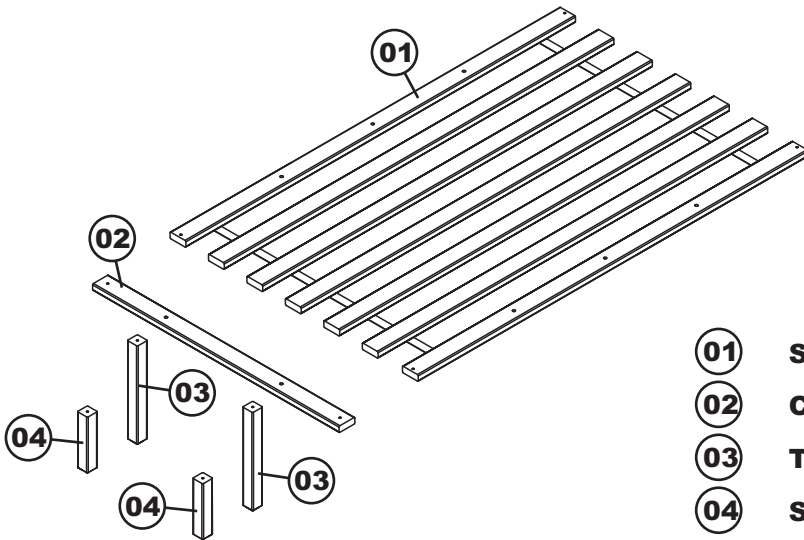

PO :

01	SLAT SECTION	2 SET
02	CENTER RAIL	2 PCS
03	TALL SUPPORT LEG	4 PCS
04	SHORT SUPPORT LEG	4 PCS

### HARDWARE

NOTE: WE INCLUDE SPARE HARDWARE IN CASE THE ALLEN WRENCH, ALLEN SCREW OR WOOD SCREW ARE DAMAGED DURING ASSEMBLY.

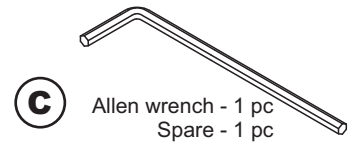
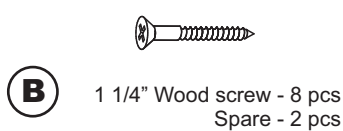

### Step 1

Assemble bed frame according to bed assembly instructions. If using mattress and foundation set the bed up low and use short support leg. If using Storage Drawers or Trundle Bed choose the tall support leg.

### Step 2

Assemble support leg (03 / 04) and center rail (02). Using Allen screw (A). Tighten with the Allen wrench (C). Repeat for other center rail.

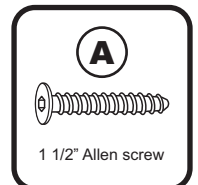
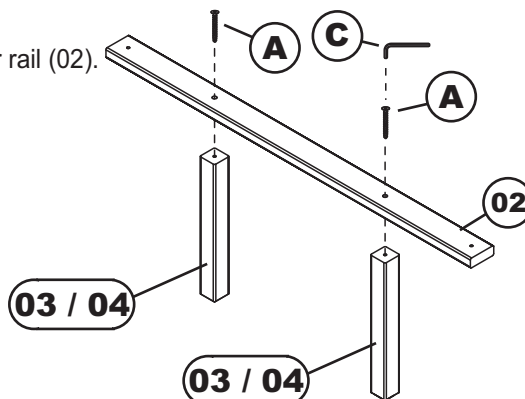
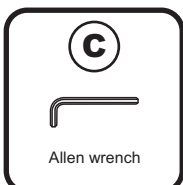

# SLAT KIT FULL BED

## Step 3

Lay the slat kit (01) onto the bed.  
 Attach center rail (02) to slat kit (01).  
 Using Allen screw (A), tighten with the Allen wrench (C).  
 Repeat for section 2.

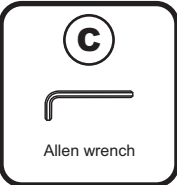
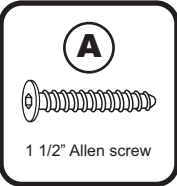
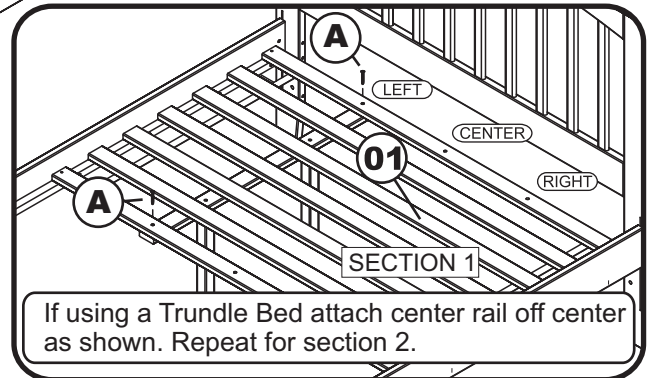
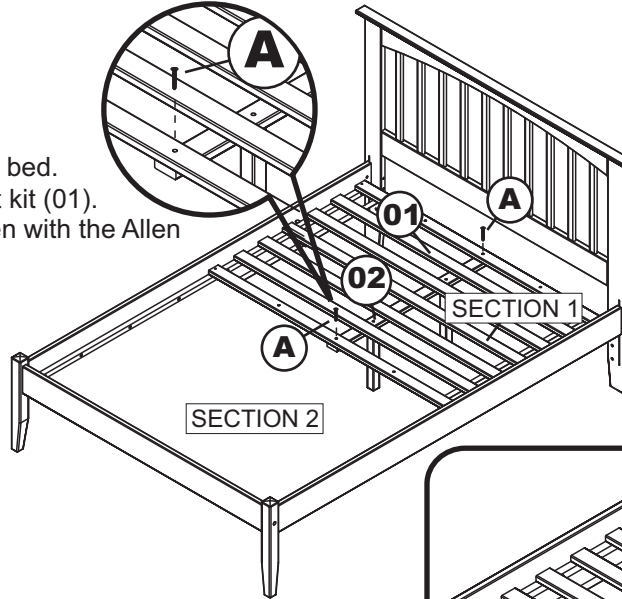

## Step 4

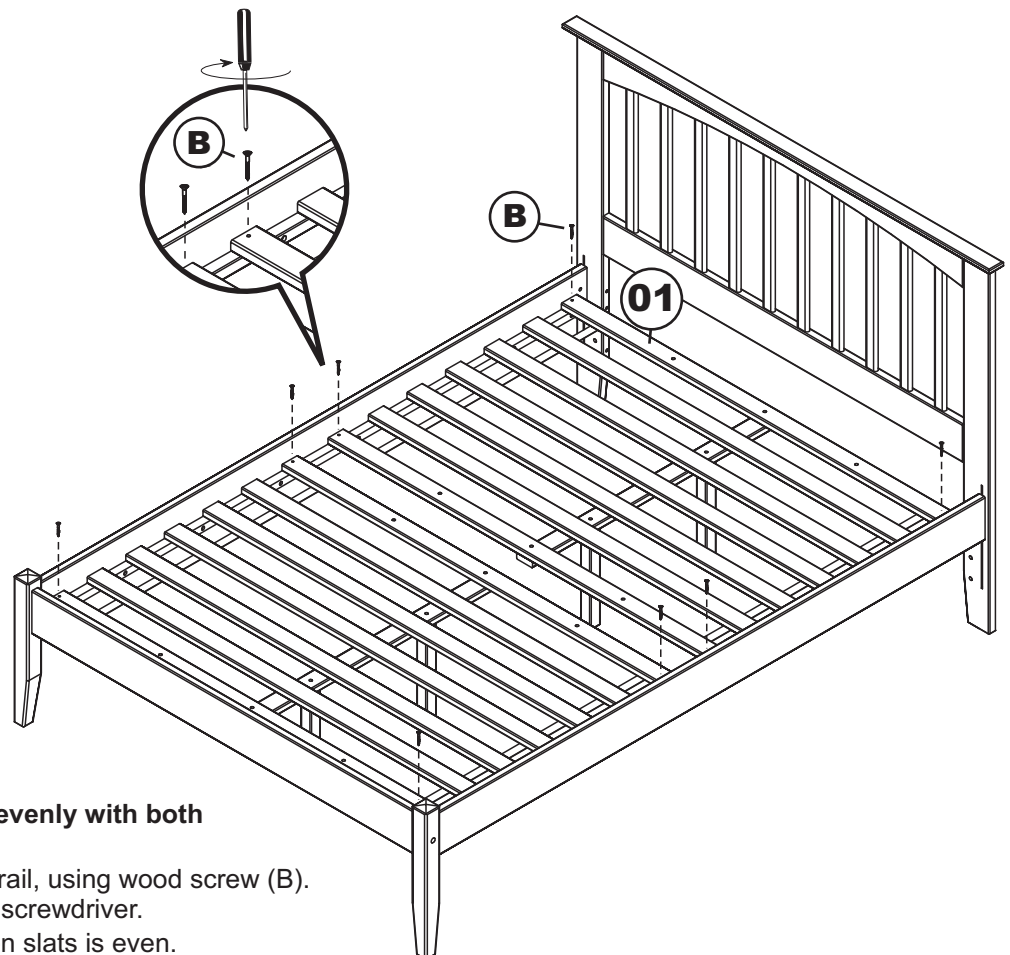
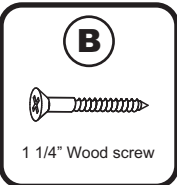

**Be sure to align slat kit evenly with both ends of ledger strip.**  
 Screw slat kit (01) to side rail, using wood screw (B).  
 Tighten with Phillips head screwdriver.  
 Be sure the space between slats is even.