

# ASSEMBLY INSTRUCTION

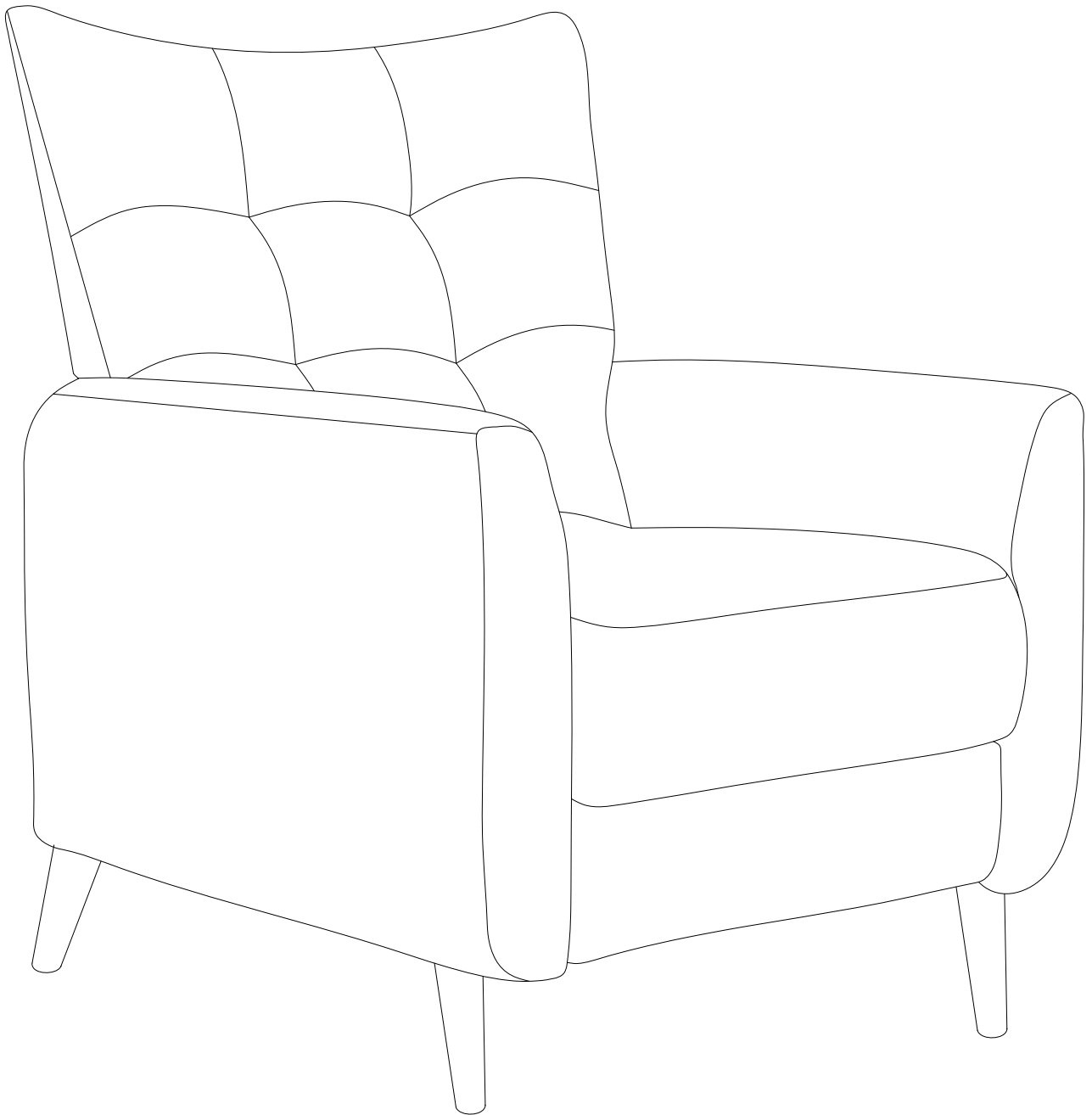

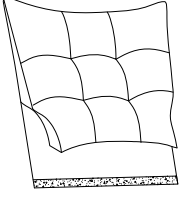

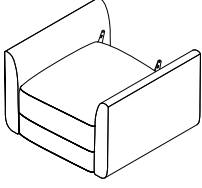
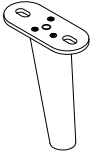

# ASSEMBLY INSTRUCTION



## PARST LIST

A*1		Back	B*1		Seat
C*4		Leg			

## HARDWARE LIST

D*8		Bolt	E*8		Flat washer
F*8		Spring washer	G*1		Allen key

## SPARE

D*1		Bolt	E*1		Flat washer	F*1		Spring washer
-----	---	------	-----	---	-------------	-----	---	---------------

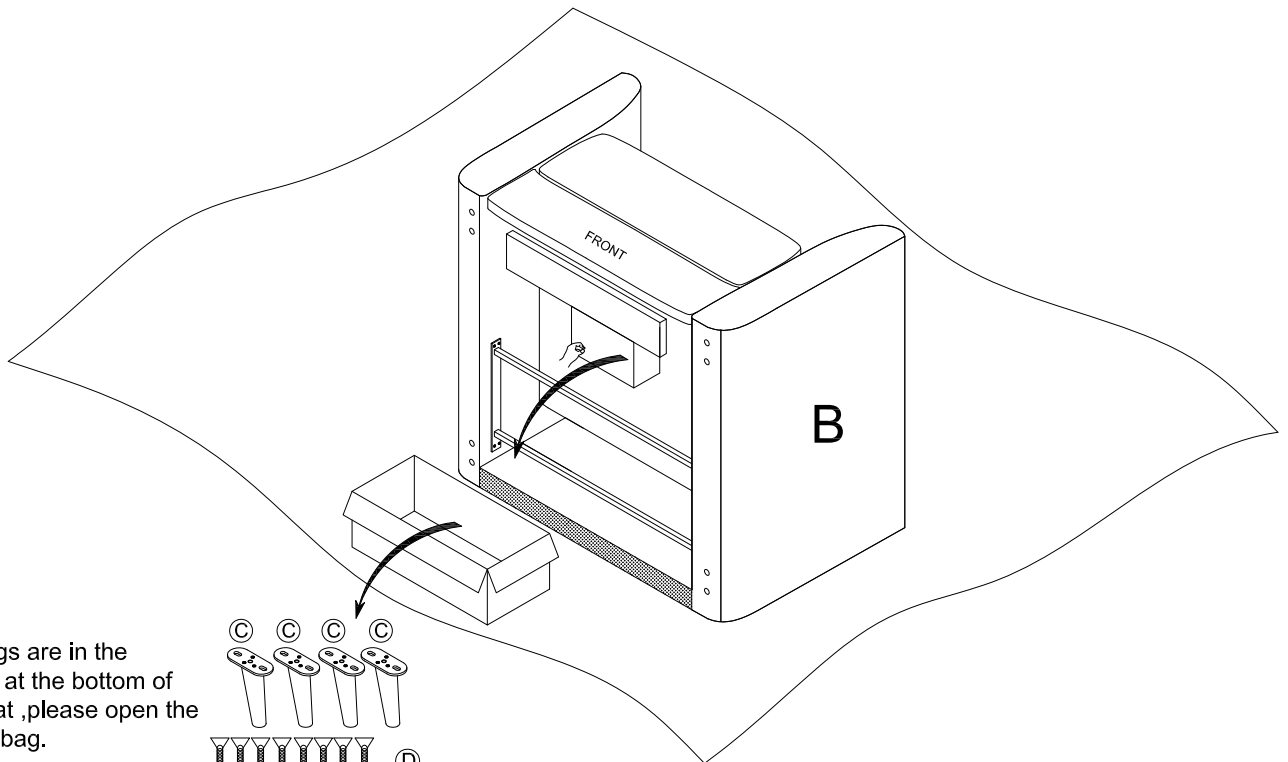

The legs are in the pocket at the bottom of the seat ,please open the zipper bag.

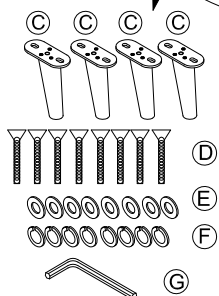

## STEP 1.

# ASSEMBLY INSTRUCTION

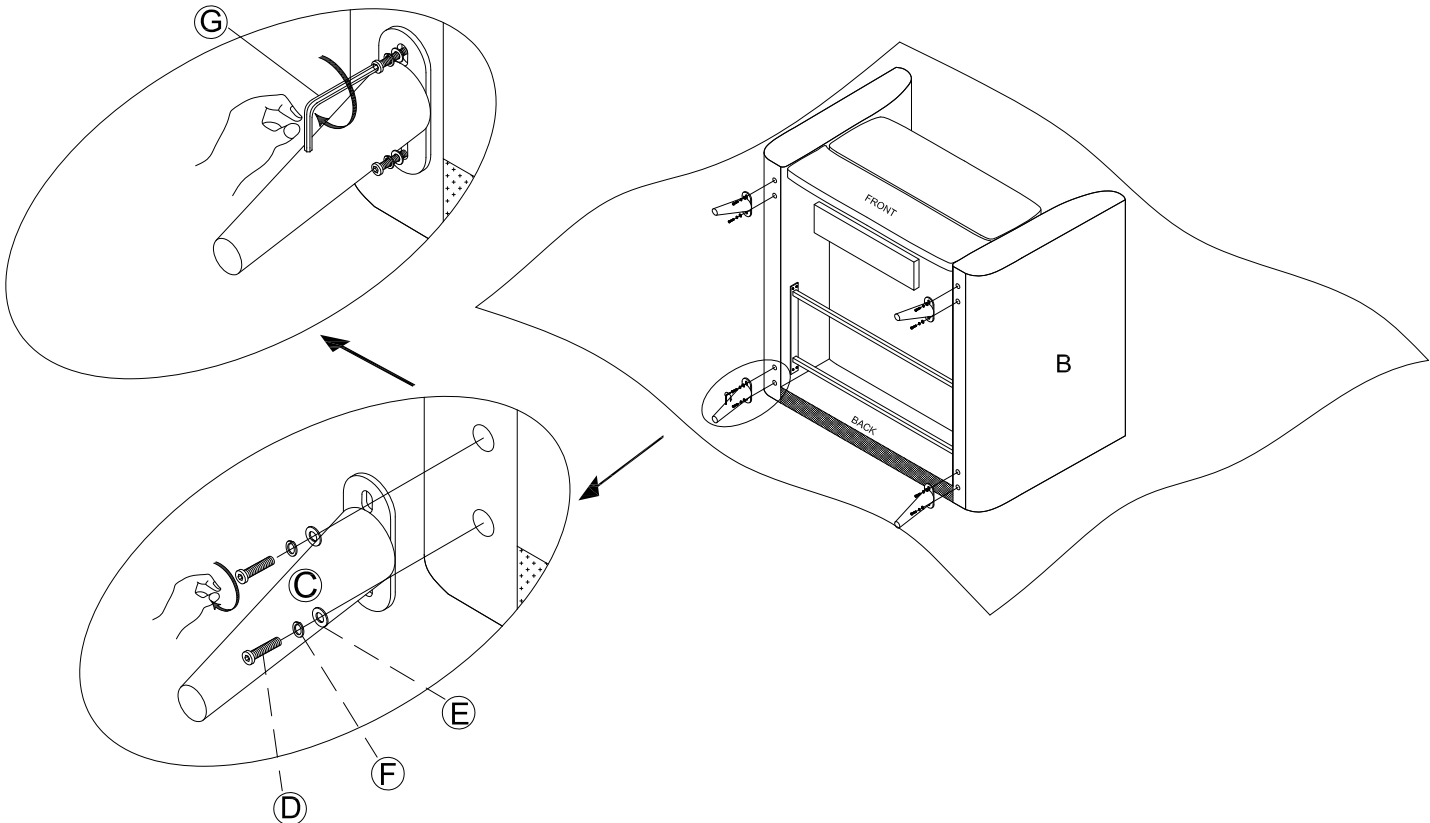

STEP 2.

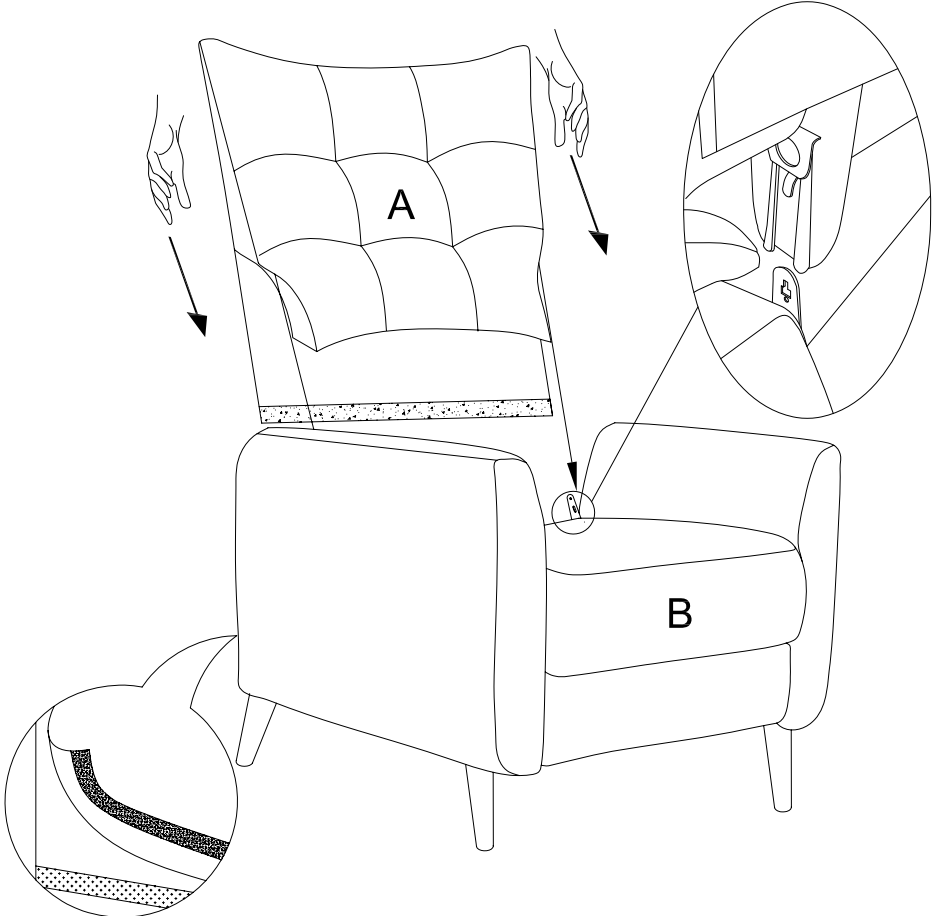

STEP 3.

# ASSEMBLY INSTRUCTION

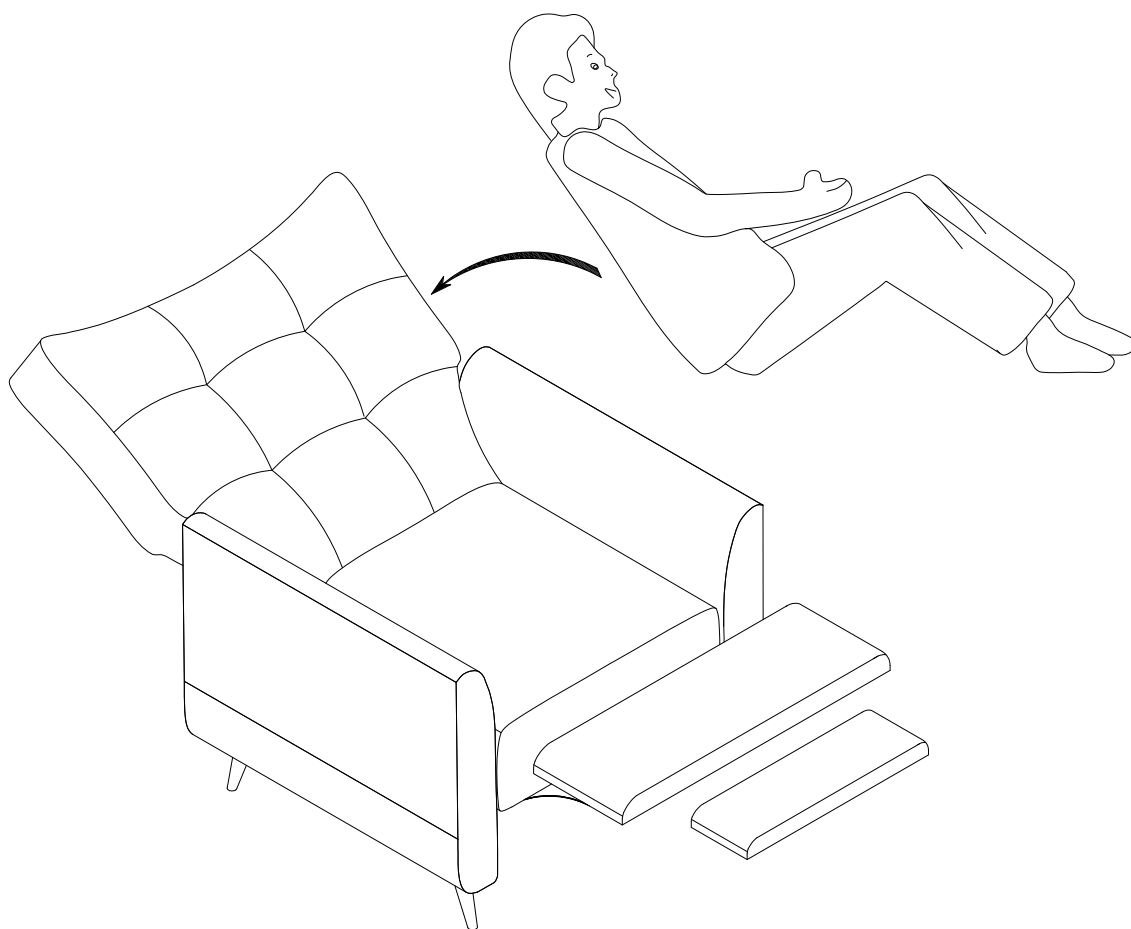

STEP 4.

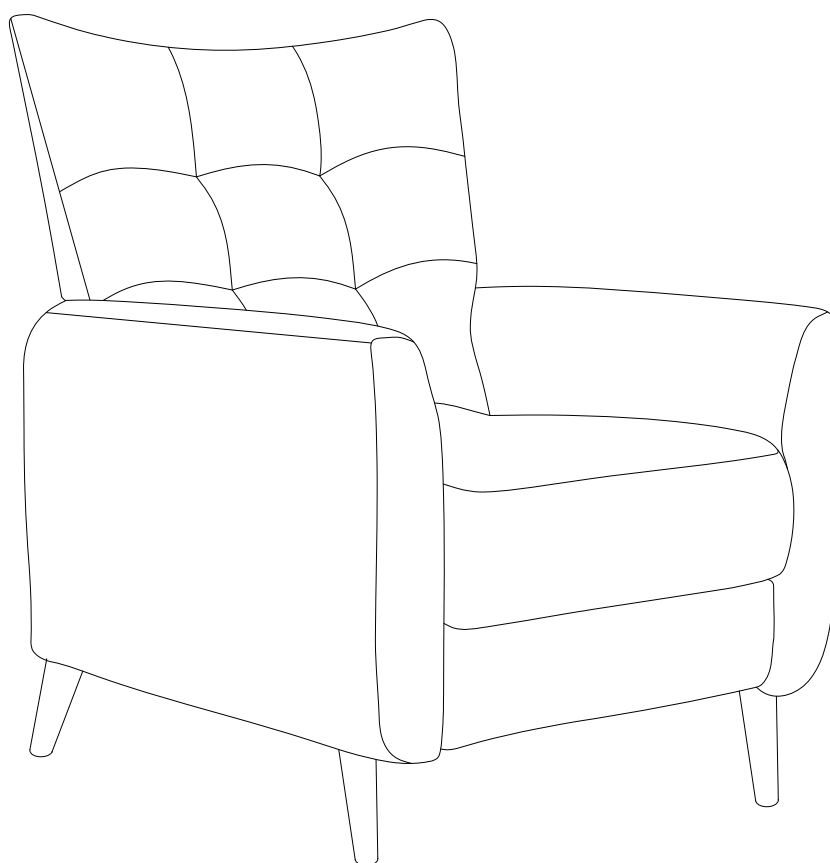

STEP 5.

## WARRANTY CARD

### After-sale Service Warranty:

We strive to offer high-quality products, and we also try our best to satisfy each and every customer that orders from us with product or service as needed. We provide 30 days warranty starting from the time you receive the item. Each customer must provide a record of their order such as the order number, or item receipt for any items that are out of the warranty period you may also still receive replacement parts by purchasing them with our company if they are available.

### ABOUT Q&A:

**Q: The item has arrived, but it is different from what I ordered.**

A: Dear customer,

If you received the wrong item, please contact us.

It will be helpful to us if you can send us some pictures of the item you received and the outer box including SKU. And please don't forget to attach your order number and phone number

In general, emails will be answered within 24 hours

**Q: I ordered several items or a set of product , but I only received a portion of the items**

A: There are multiple boxes if you ordered several items or a set of product, please wait for a few more days.

If you still did not receive the rest, please contact us.

It will be helpful to us if you could tell us the tracking number of the received items. And please don't forget to attach your order number and phone number

In general, emails will be answered within 24 hours

**Q: I have some trouble assembling the item**

A: You can refer the assembly instruction inside the package. If the assembly instruction missing, or if you still have any question in assembly, please contact us.

And please don't forget to attach your order number and phone number

In general, emails will be answered within 24 hours

**Q: The item has arrived, but there was a missing part for the item.**

A: If a part is missing, please check if it was left in the corner firstly

If you still could not find it, please contact us.

It will be helpful to us if you could tell us the part number of missing part on the instructions. And please don't forget to attach your order number and phone number

In general emails will be answered within 24 hours

**Q: The item has arrived, but it was damaged.**

If a part is damaged, please contact us.

It will be helpful to us if you can send us some pictures of the damaged part, so that we can send you the replacement part(s) soon afterward. And please don't forget to attach your order

emails will be answered within 24 hours

# Returns Policy

Dear Buyer,

Thanks for your support at us! We want you to be happy with your purchase from us. As we work to exceed your quality and service expectations, sometimes we fall short. In those cases, if you are not satisfied with the item purchased from us, we will gladly accept unused return items within 30 days after the original purchase date. Below policy can help you deal with your returns or exchanges smoothly.

## Returned Product & Packing

\*Please keep in mind that furniture is vulnerable to damage during shipping. For this reason, it's important that you please keep and use the original packaging materials for any items you wish to return especially for chair legs.

\*To help us identify your package and quicker process refunds, please ensure the package shows your order id and kindly inform us when you ship the returns out.

## Return Shipping Cost

You will be responsible for the return shipping cost. You will need to paid for the return shipping label when shipping items out or the shipping cost will be deducted from the refunds when you get provide prepaid shipping label from us.

## Refunds

\*Please allow 10-15 business days after it's received to inspect your return and process your refunds. Allow a minimum of 30/45 days for the return/credit process and posting for a credit card you will be credited in the same manner as the original purchase was made.

\*Shipping and Handling charges are not refundable, including residential fees.

\*If the returns arrived in unsalable condition, a restocking fee of 15% of the item price may apply. We are unable to issue refunds for products returned that are soiled, totally damaged or missing parts.

\*The refund, less shipping & restocking fees, will be made within 30 days of return and may be delayed due to any damage claim by the carrier. Refund approval is dependent on inspection results.

## Exchanges

If the item does not arrive as described or is damaged, please feel free to contact us. We will fix the issue and ensure you're satisfied with the resolution.