

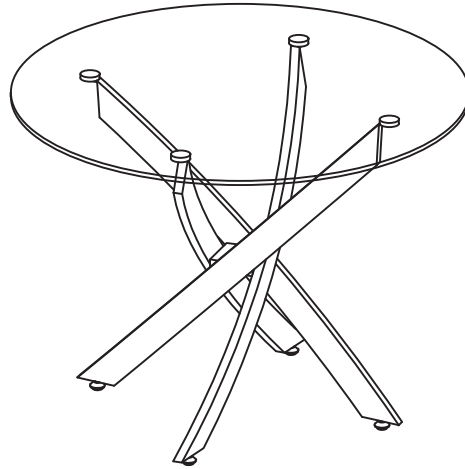



Item No. DT666

Assembly Instructions





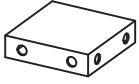

Please install the products on carpet or soft place

Parts List

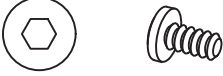
NO.	Sketch	Description	Qty
A		Glass Top	1
B		Leg	4
C		Iron Box	1
D		Adjustable Feet	4

Hardware List

NO.	Sketch	Description	Qty
1		Bolts M8x16	8
2		Bolts M8x8	4
3		Offset Ring Spanner	1
4		Allen Key	1
5		Washer 8x18	4

STEP 1

The hole spacing corresponds to the leg

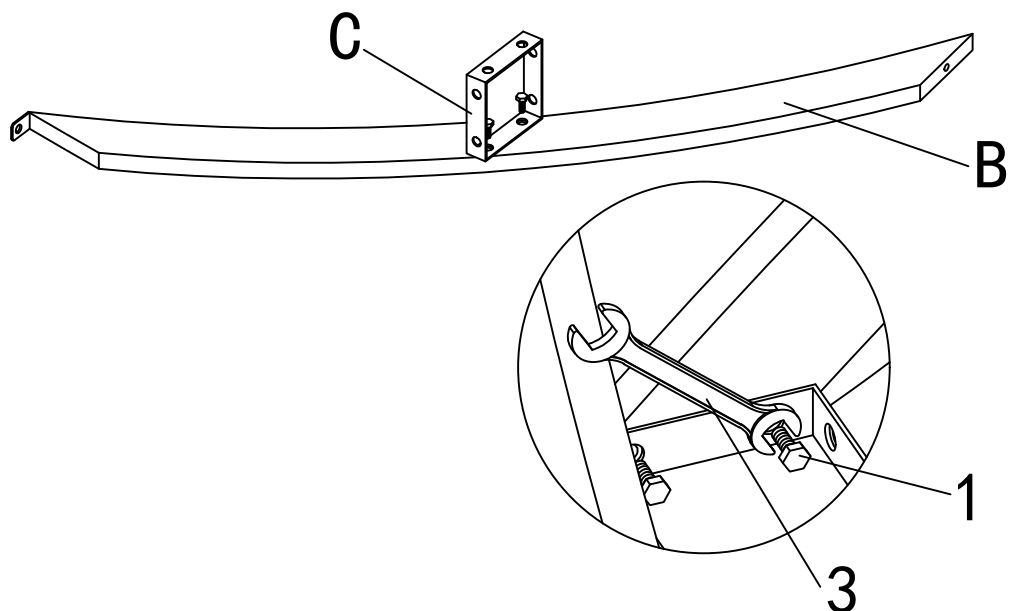

Note: The opening direction of the box should be consistent with the picture

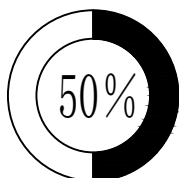

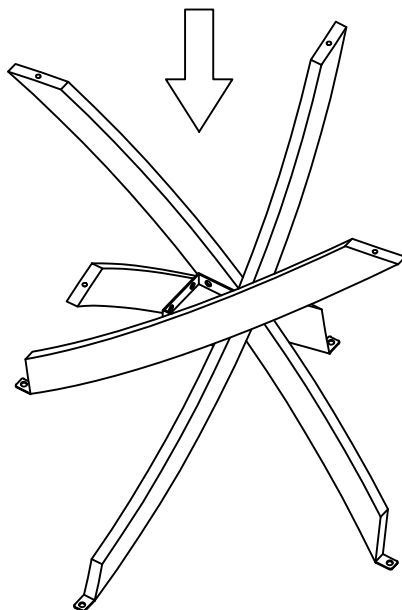

50% tighten all the screws

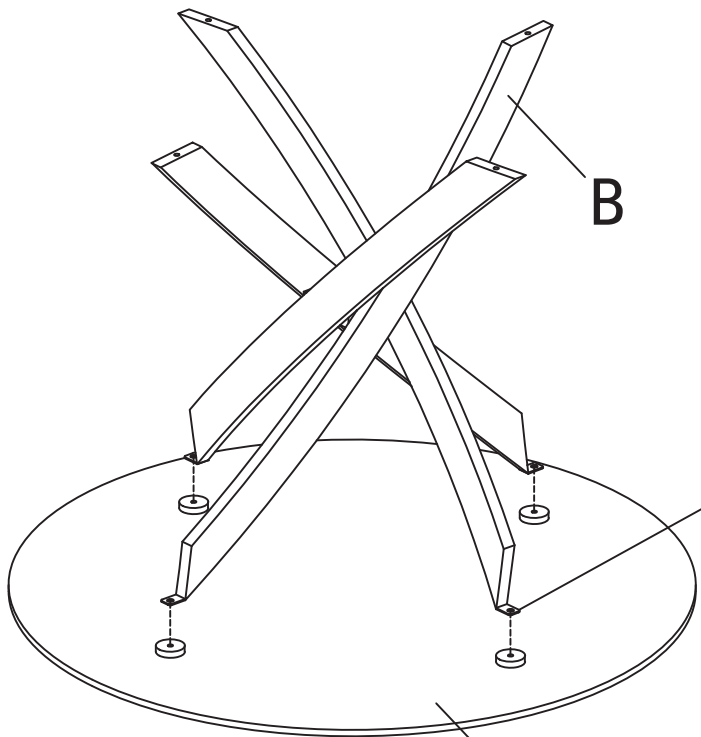

STEP 2

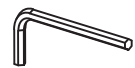

- 4 
- 2 
- 5 

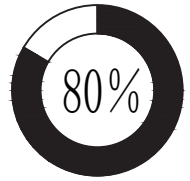
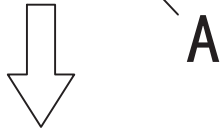
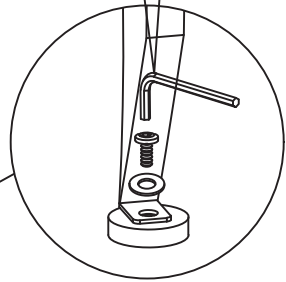

80% tighten all the screws

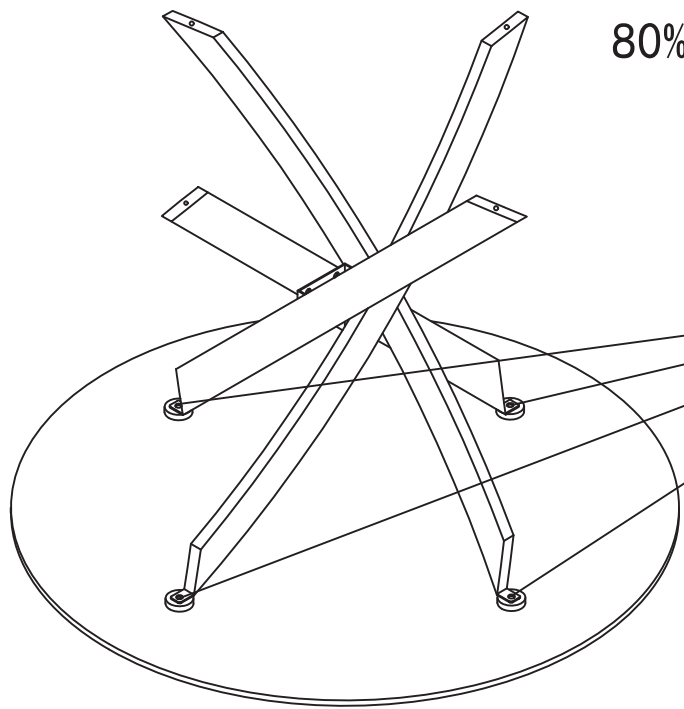

STEP 3

1.

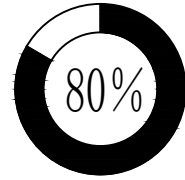

80% tighten all the screws

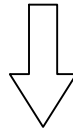
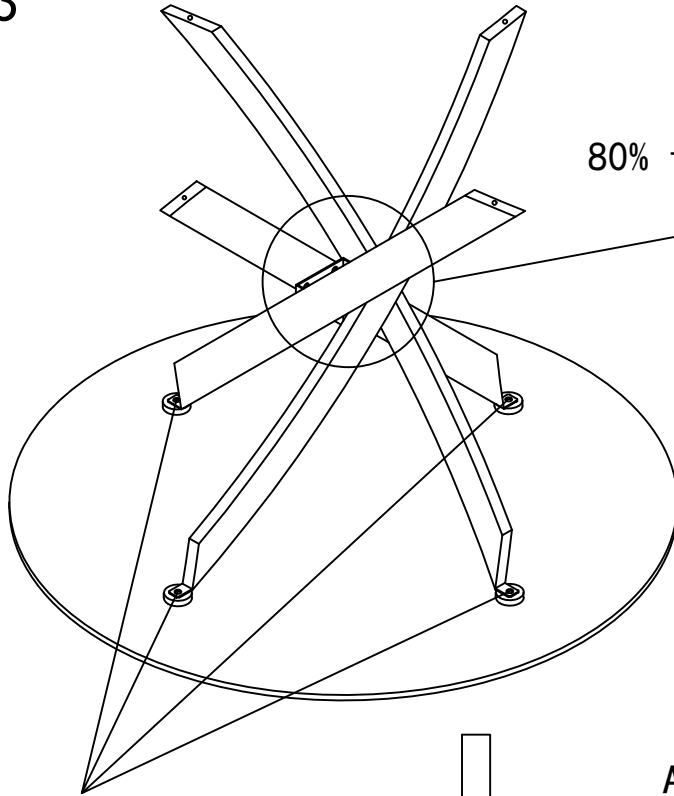

After aligning feet

2.

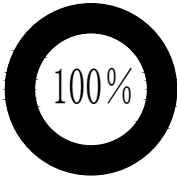

Tighten all the screws

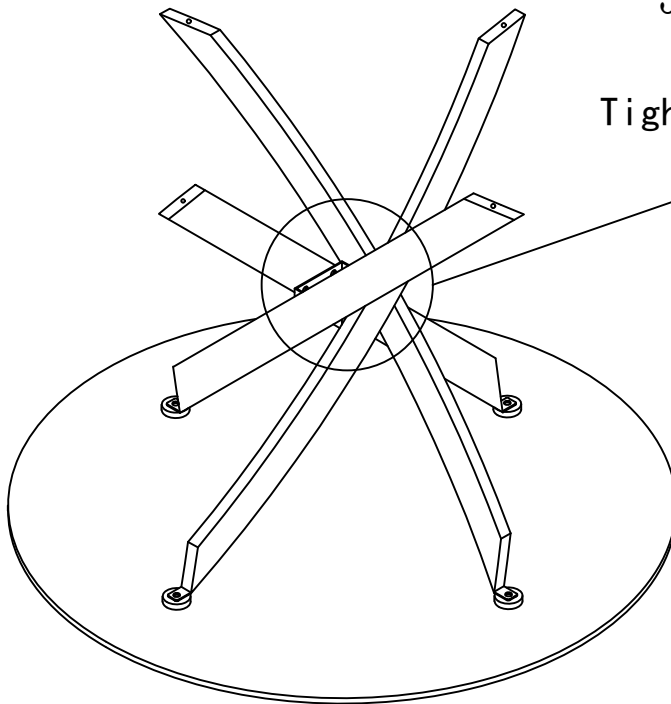

3.

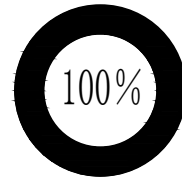

Tighten all the screws

STEP 4

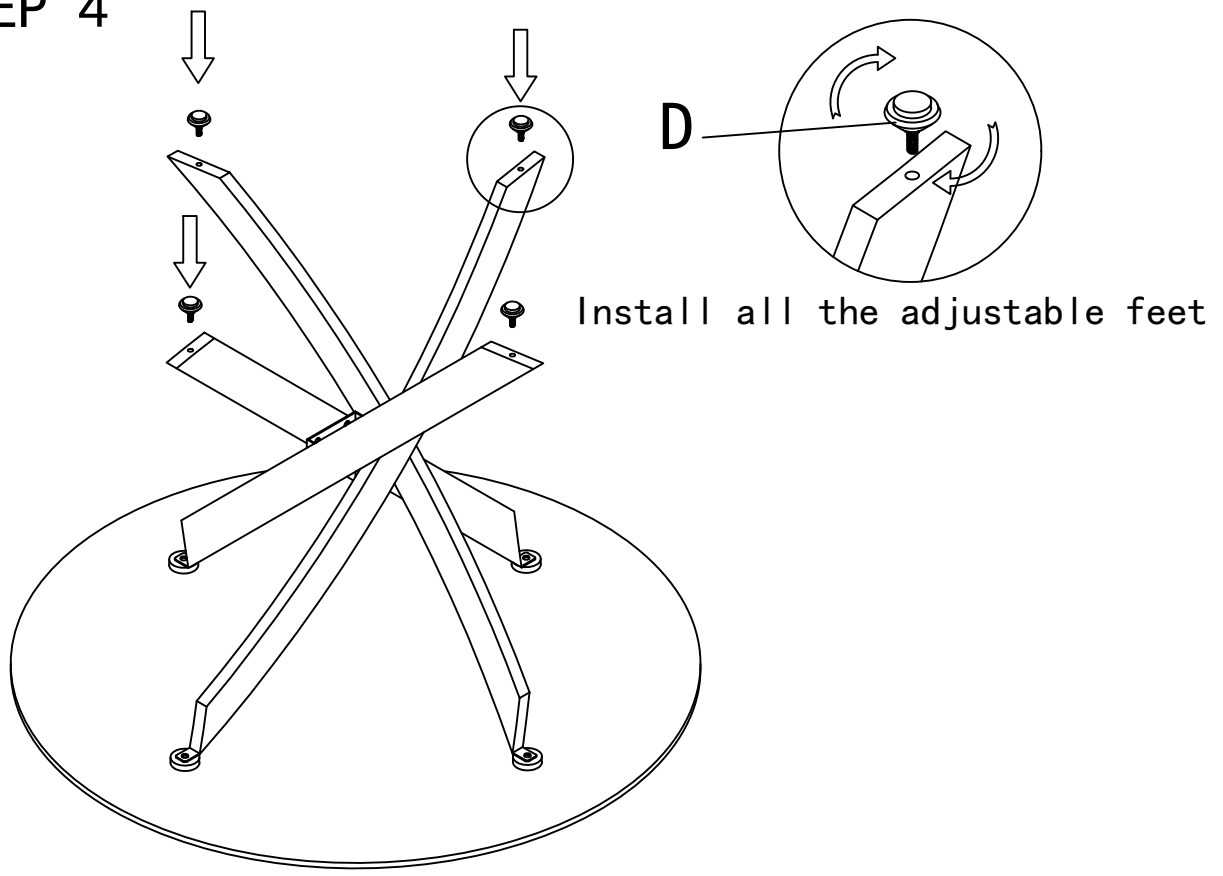

COMPLETED

