

# S2515-30 Vanity Installation Instruction

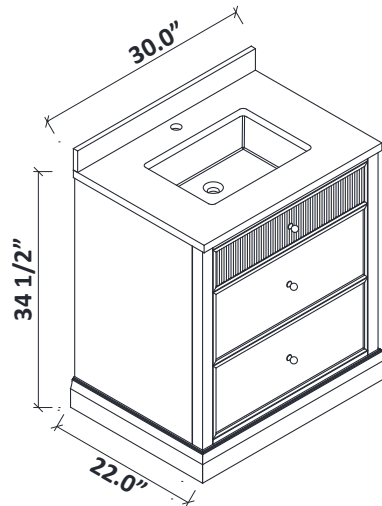

## DIMENSIONS

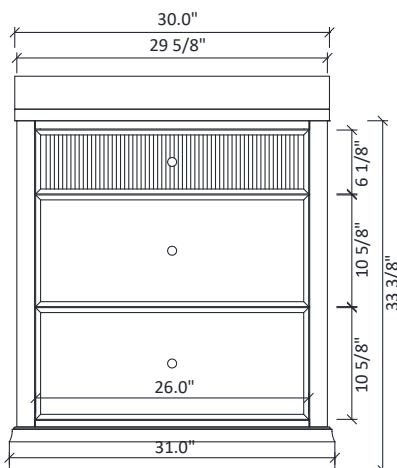
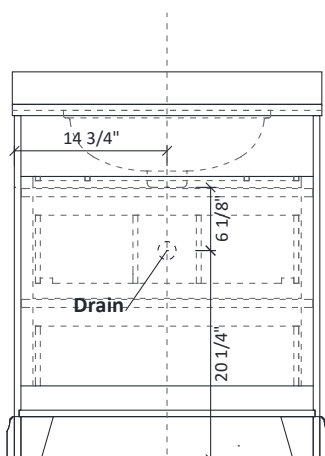
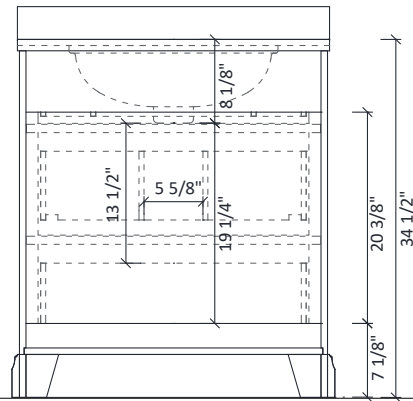
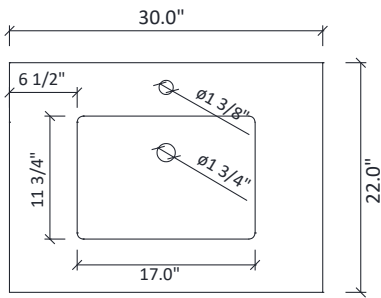

### **WARNING !**

*In the hole on the wall, please be sure to be careful to avoid the internal cables and pipelines.*

## MATERIALS & TOOLS

*Safety glasses, Pencil, Level, Tape measure, Stud Finder, Assorted screwdrivers, Assorted Wrenches, Drill, Screw gun, Caulking gun, Hammer, Screws, Nail anchors/Molly screws.*

► Backsplash installation

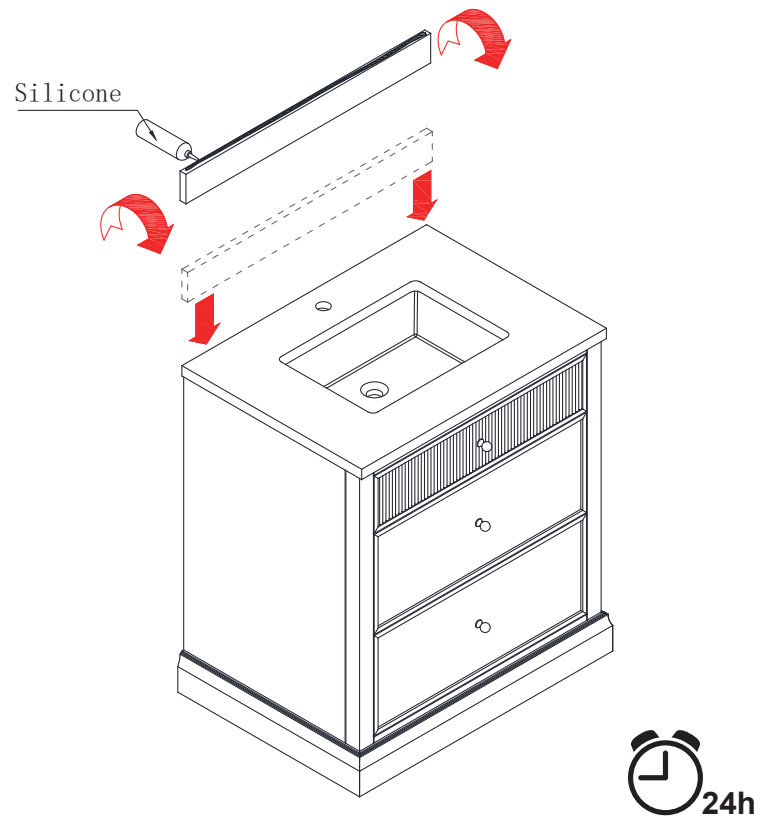

- If the floor is uneven, the adjustable feet levelers can be rotated to raise the vanity to the desired height.

