

Assembly Instructions

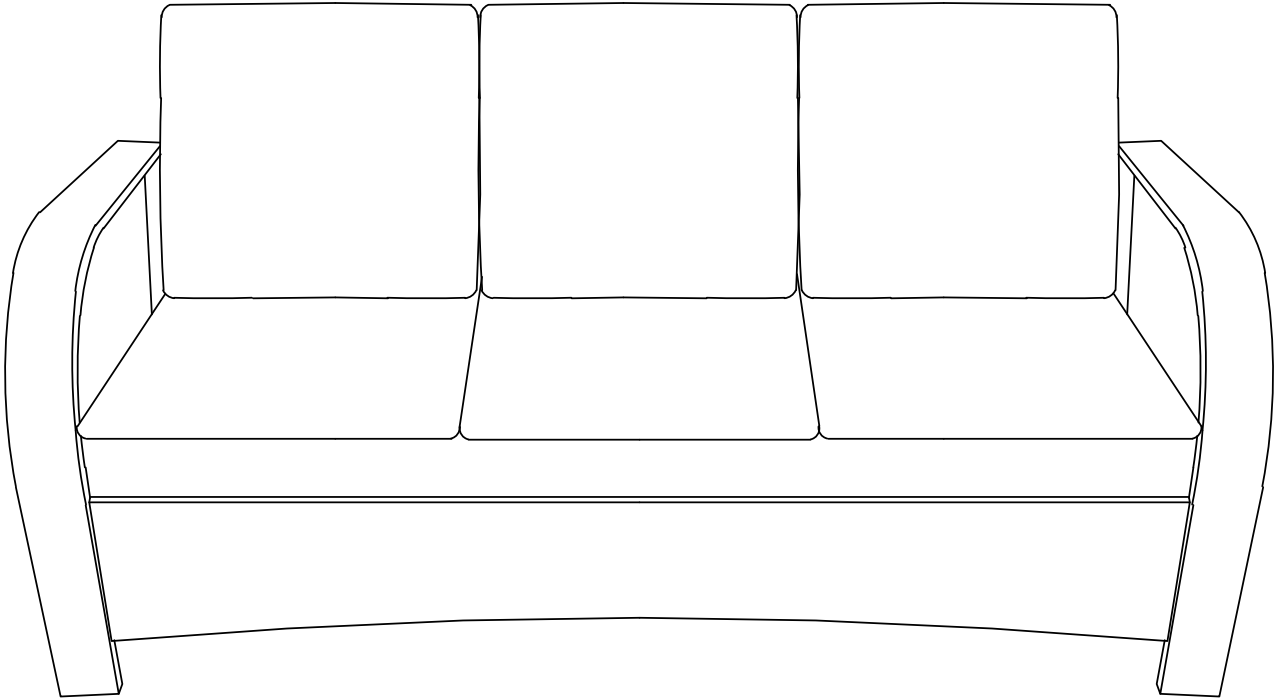











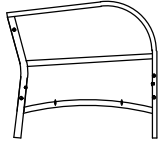

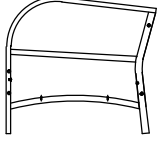

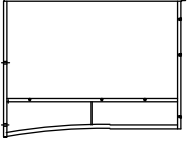
For any missing hardware, damaged parts and other problems.

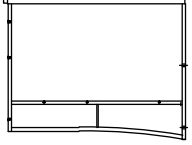
WELCOME to email us.

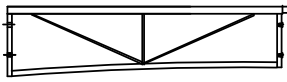
***Don't fully tighten all the bolts till the very end!**

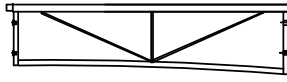

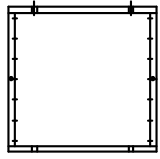
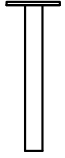
PRE-ASSEMBLY PREPARATION:

- Please read through the instructions before beginning assembly.
- Clear out the space for assembly and lay out all of the parts based on the Parts List, extra room will allow you to easily determine if all the pieces are present.
- Keep small parts and pieces away from children until fully assembled.

Part no.	Part	QTY	Image	Part no.	Part	QTY	Image
A1	Left arm	1		G	Bolt (M6*40mm)	12	
A2	Right arm	1		H	Bolt (M6*35mm)	13	
B1	Right back panel	1		I	Washer M6	29	
B2	Left back panel	1		J	Allen wrench	1	
C1	Right front panel	1		K	Seat cushion	3	
C2	Left front panel	1		L	Back cushion	3	
D	Seat panel	3					
E	Middle foot	2					
F	Bolt (M6*15mm)	4					

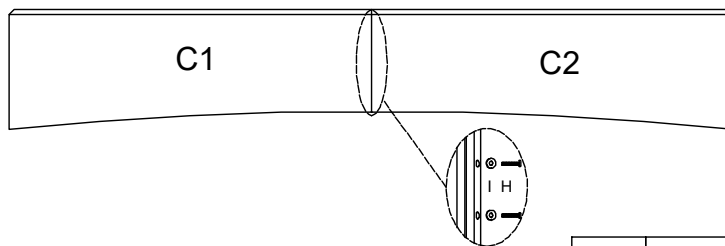
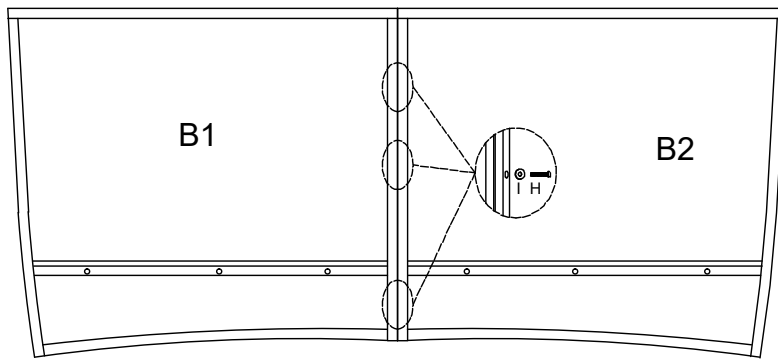

Step 1: Attach back panels B1 & B2 and front panels C1 & C2, with 5pcs bolts H and 5pcs washers I, using Allen wrench J. Note: Don't fully tighten the bolts.



H		M6*35	5
I		M6	5

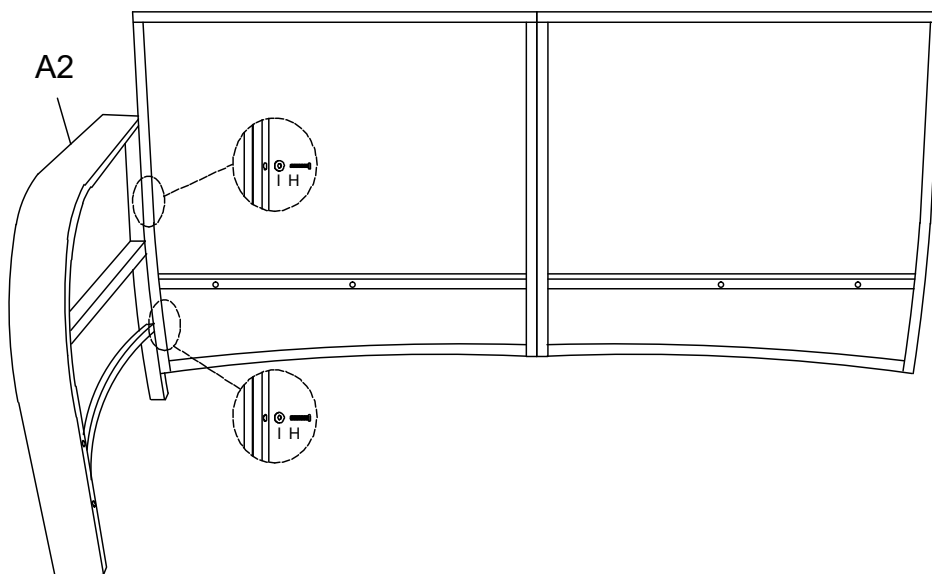

Step 2: Attach right arm A2 to back panels B1 & B2 with 2pcs bolts H and 2pcs washers I, using Allen wrench J. Note: Don't fully tighten the bolts.



H		M6*35	2
I		M6	2

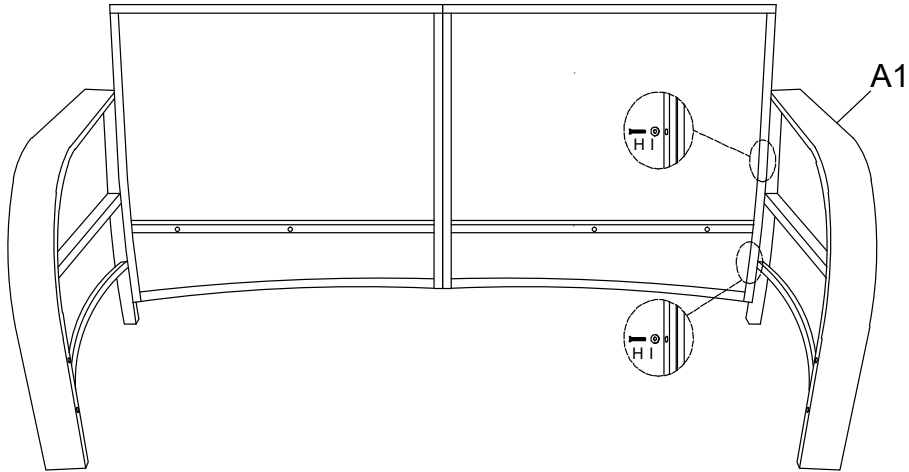

Step 3: Attach left arm A1 to back panels B1&B2 with 2pcs bolts H and 2pcs washers I, using Allen wrench J. Note: Don't fully tighten the bolts.



H		M6*35	2
I		M6	2

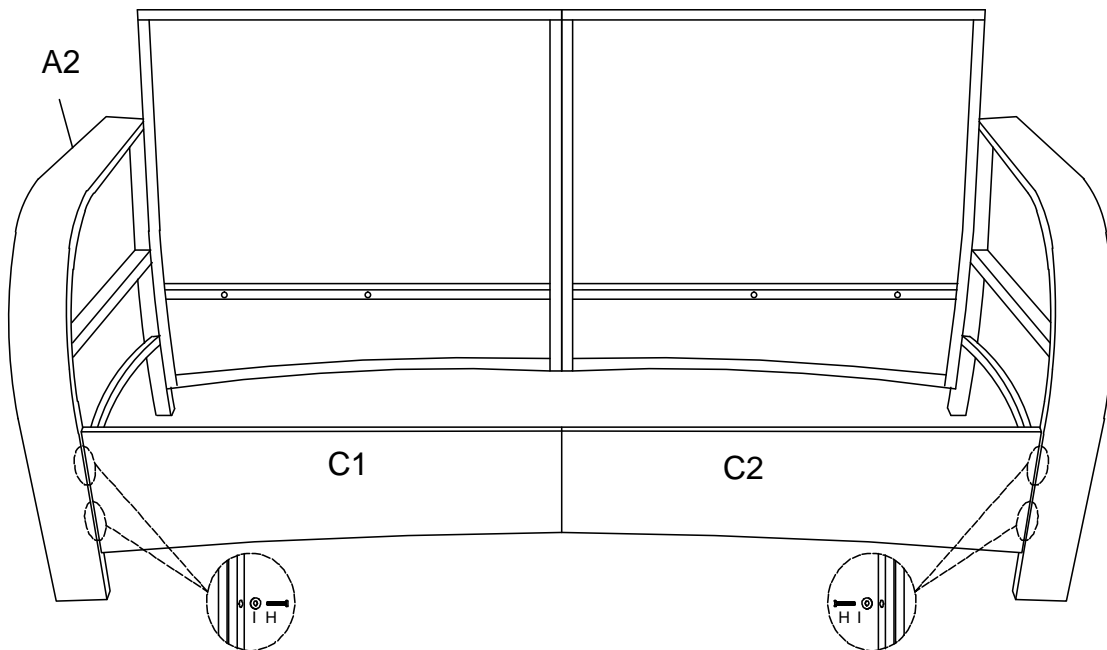

Step 4: Attach front panels C1&C2 to arms A1&A2 with 2pcs bolts H and 2pcs washers I, using Allen wrench J. Note: Don't fully tighten the bolts.



H		M6*35	4
I		M6	4

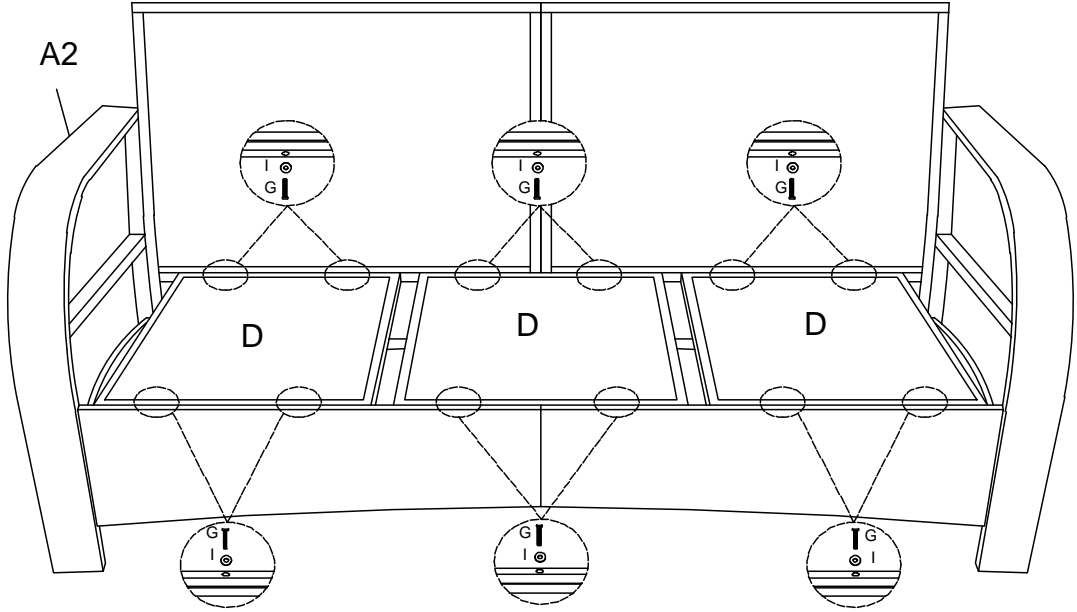

Step 5: Attach seat panels D to back panels B1&B2 and front panels C1&C2 with 12pcs bolts G and 12pcs washers I, using Allen wrench J. Note: Don't fully tighten the bolts.

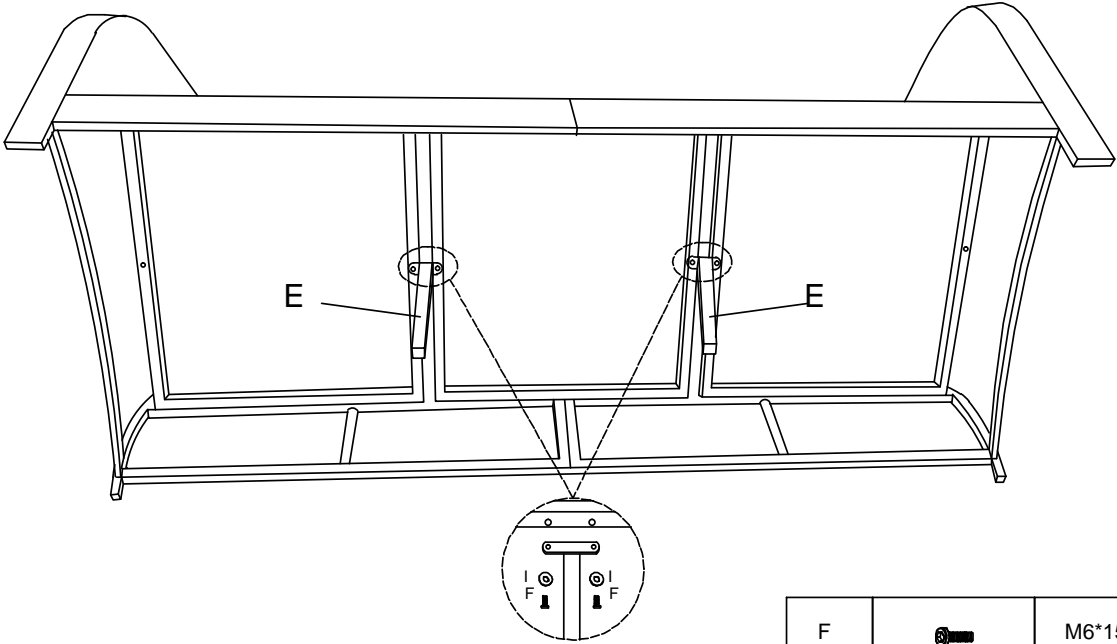

G		M6*40	12
I		M6	12

Step 6: Attach middle feet E to seat panels D with 4pcs bolts F and 4pcs washers I, using Allen wrench J. Note: Please fully tighten the bolts.



F		M6*15	4
I		M6	4

Step 7: Put seat cushions K and back cushions L onto the seat. Assembly is now complete and the product is ready for use.

