

GYM MIRROR ASSEMBLY INSTRUCTIONS

● Product information ●

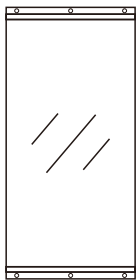

Height:48in
Width:24in

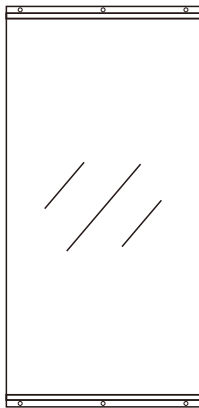

Height:72in
Width:36in

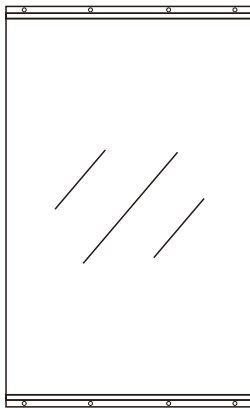

Height:72in
Width:46in

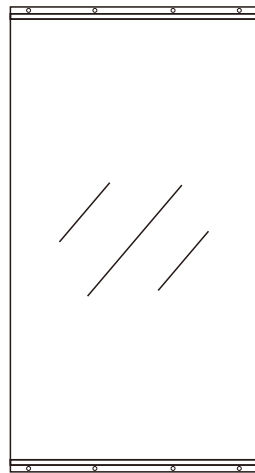

Height:84in
Width:46in

● ○ ○ ○ ○ ○ ○ ○

Let the mirror witness your every day

Material list

A

wall-mounted
accessory

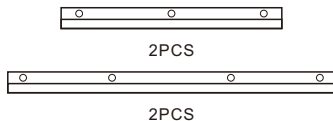

B

metal gasket



14PCS

C

plastic gasket



14PCS

D

decorative screw cap



14PCS

E

plastic expansion screw



14PCS

F

metal screw



14PCS

G

double sides adhesive
tape



8PCS

H

wiping cloth



1PCS

⚠ Please refer to the actual receipt of the quantity of accessories.

● Installation steps ●

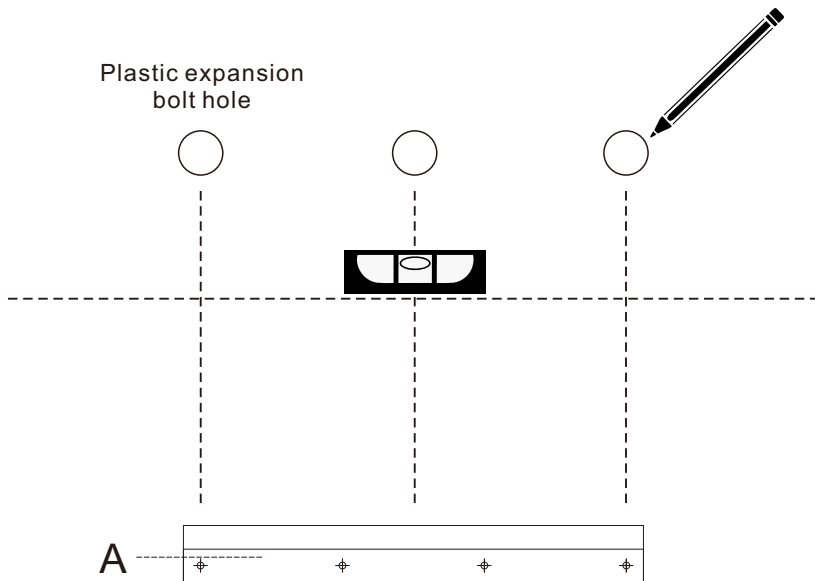

Mark the drilling position of
the E(plastic expansion screw)
on the wall with a level

△ In order to avoid injury to you and your family, please install carefully.

● Installation steps ●

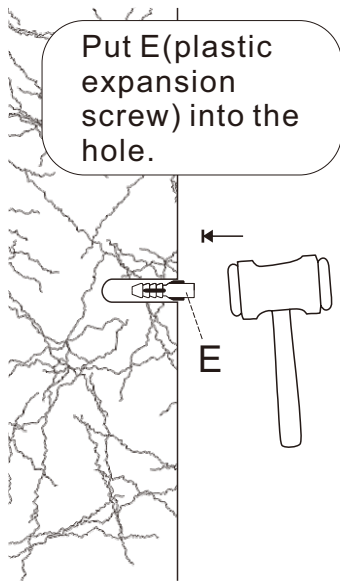
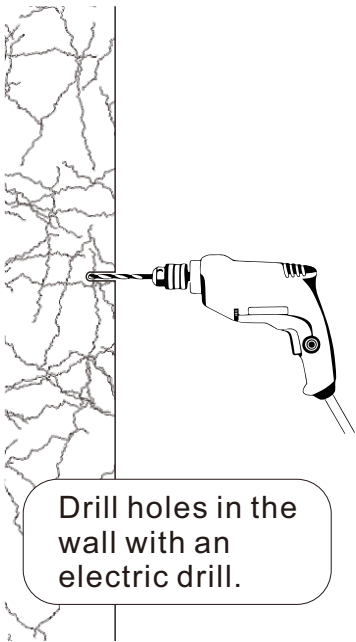

⚠ In order to avoid injury to you and your family, please install carefully.

● Installation steps ●

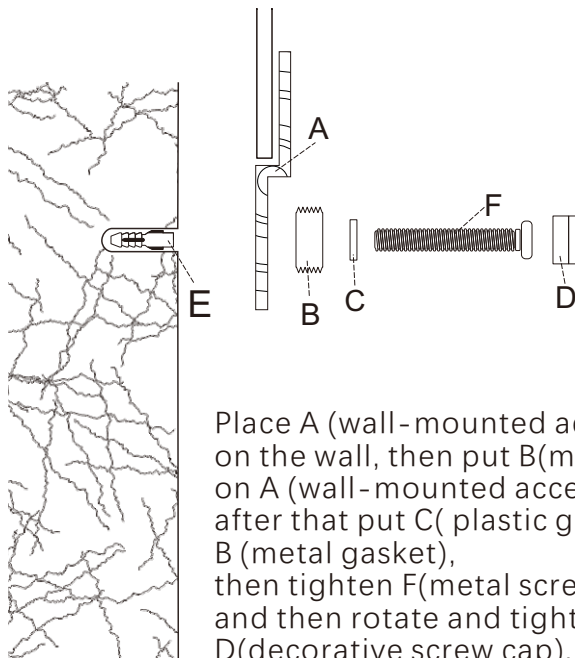

Place A (wall-mounted accessory) on the wall, then put B (metal gasket) on A (wall-mounted accessory), after that put C (plastic gasket) into B (metal gasket), then tighten F (metal screw), and then rotate and tighten D (decorative screw cap).



⚠ In order to avoid injury to you and your family, please install carefully.

Installation steps

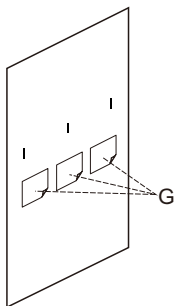

Stick I(double-sided adhesive tape) in the middle of the back of the mirror, then place it on the wall and hold it in A (wall-mounted accessory). Be sure to press down on the mirror to prevent it from falling. At this point, the mirror has not been completely fixed.

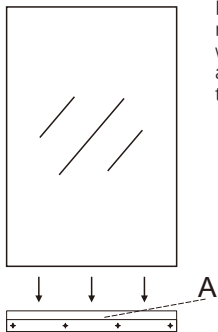

Please place the mirror on the wall mounting accessory from the top.

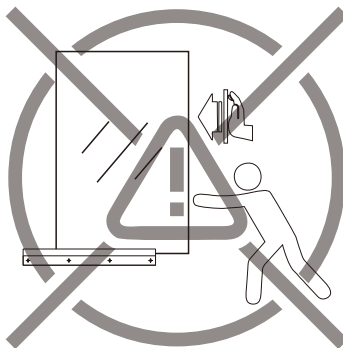

 It is forbidden to push the mirror in from the side.

 In order to avoid injury to you and your family, please install carefully.

● Installation steps ●

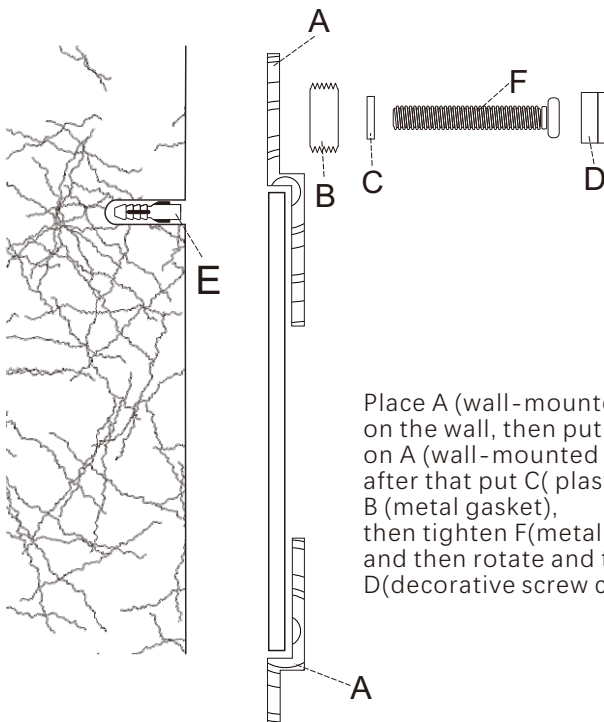

Place A (wall-mounted accessory) on the wall, then put B(metal gasket) on A (wall-mounted accessory), after that put C(plastic gasket) into B (metal gasket), then tighten F(metal screw), and then rotate and tighten D(decorative screw cap).

△ In order to avoid injury to you and your family, please install carefully.

● Installation complete ●

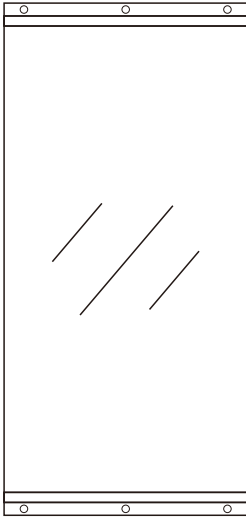

Vertical

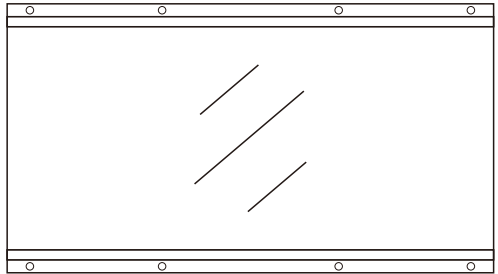

Horizontal



Let the mirror witness your every day