

# Owner's Manual

## 3 Piece Casual Set

---

**NOTE:**

---

The instruction booklet contains **IMPORTANT** safety information Please read and keep for future reference.

---

## OUR BRAND

selection of high-quality indoor and outdoor furniture, appliances, and accessories. We are committed to making decorating your home easy, affordable and fun. Everything you need to make your house into a beautiful home can be found at our website. So whether you shop by website or catalog, you can be sure you will always find top-quality merchandise for your home.

PLEASE LIKE, COMMENT AND SUBSCRIBE.



---

## TABLE OF CONTENTS

OUR BRAND .....	03
PARTS AND HARDWARE .....	04
ASSEMBLY INSTRUCTIONS .....	05
WARRANTY .....	07

## PARTS AND HARDWARE

Avoid using sharp objects such as a knife to cut open packing as you may accidentally damage the upholstery.

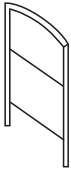

A. Right Arm  
2x

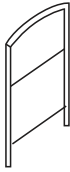

B. Left Arm  
2x

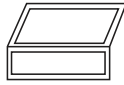

C. Seat  
2x

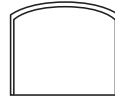

D. Backrest  
2x



E. Cushion  
2x



F. Bolt  
24x



G. Washer  
24x



H. Table Frame  
1x

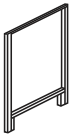

I. Table Legs  
2x

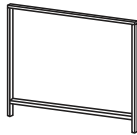

J. Table Side  
2x



K. Table Bolt  
12x



L. Table  
Washer 12x

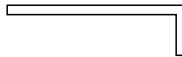

M. Allen Key  
1x

## ASSEMBLY INSTRUCTIONS

Do not fully tighten bolts until assembly is complete.

1. Assemble the chair Arms (A) and (B) to the chair seat (C) and Chair Back (D) using bolts (F) and washers (G).

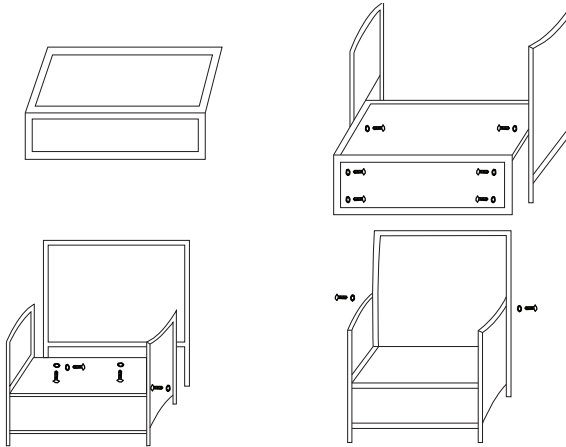

2. Assemble the table legs (I) to the table sides (J) to the table frame (H) using bolts (K) and washers (L).

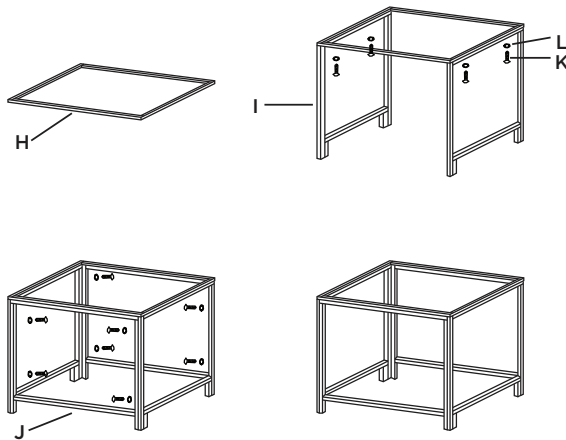

# ASSEMBLY INSTRUCTIONS

3. Place seat cushions on chair frames and enjoy your new outdoor dining set.

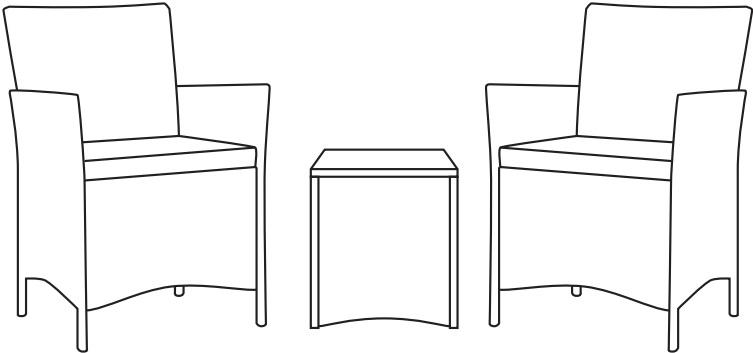

# LIMITED TERM WARRANTY

ONE (1) YEAR FROM DATE OF PURCHASE

## WARRANTY TERMS

We warrant that our merchandise are free from manufacturing defects (workmanship and/ or material) and will either give credit or replace defective parts for a period of up to one (1) year from the date of purchase in accordance with the conditions set forth below.

## ADDITIONAL CONDITIONS

The following examples are not manufacturer's defects:

- Colors may vary slightly from the photo because of photography and printing tolerances.
- Sizes are stated in U.S. standard measurements while the actual sizes are manufactured using the metric system. Therefore the sizes may vary slightly.
- There are no exchanges or refunds on any pillows or toppers sold.
- No returns for buyer's remorse.
- \* No returns - other than stated above - will be accepted

## ADDITIONAL CONDITIONS

Warranty is void for any of the following conditions:

- 1 Improper maintenance or improper use resulting in damage.
- 2 Any product modifications by dealer, consumer, or other parties not authorized by us will void this warranty.
- 3 Floor samples sold or products designated "AS IS" at the time of purchase are not covered by the warranty.
- 4 Warranty does not cover minor variations or differences between floor samples or printed illustrations and your furniture.
- 5 Cost of packaging and shipping to and from our manufacturer is not covered by the warranty unless expressly arranged by us.
- 6 This warranty covers only articles of appliances intended for residential use only, does not cover any industrial, commercial, institutional, or rental use.
- 7 Dissatisfaction due to buyer's remorse.
- 8 Normal wear and tear.
- 9 Damages incurred during transportation.
- 10 Damages incurred during assembling or maintenance.
- 11 Damages incurred by accidents or abuse.

Additional conditions for warranty on upholstery are listed on the attached addendum.