

# ASSEMBLY INSTRUCTIONS / INSTRUCTIONS D'ASSEMBLAGE









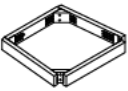

## 5 PC PACK DINETTE - SIDE CHAIR / ENS. DINETTE 5 MCX. - CHAISE DROITE

Thank you for purchasing this product. Please take time to read and follow the instructions below. Check that you have all parts and hardware before assembly. Parts apparently missing are often found in the packing materials. If you do not have all the parts listed, have your dealer contact us and they will be sent to you immediately.

**⚠** It is recommended to install protective pads under all legs and supports to avoid damage or scratches when placing furniture on or other hard surface, and to limit indentation and prevent discoloration if placing on carpet.

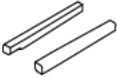
Merçi d'avoir acheté ce produit de qualité. Vérifiez avant le montage que vous avez toutes les pièces et fixations. Les pièces qui semblent manquer se trouvent souvent dans les matériaux d'emballage. Si vous n'avez pas toutes les pièces de la liste, demandez à votre détaillant et nous vous les enverrons immédiatement.

**⚠** Il est recommandé de placer des coussins protecteurs sous tous les pieds et toutes les bases des meubles pour éviter d'endommager ou d'égratigner les planchers en bois ou autres surfaces dures, et pour limiter l'empreinte et empêcher la décoloration quand les meubles reposent sur la moquette.

PART LIST / LISTE DE PIÈCES				HARDWARE LIST / LISTE DE QUINCAILLERIE			
A		Cushion Seat / Siège	4	1		Lock Washers / Rondelle D'arrêt 5/16" x 6/8" x 0.08"	40
B		Seat Frame / Cadre De Siège	4	2		Flat Washers / Rondelle Plate 5/16" x 1/2" x 0.08"	40
C		Chair Back / Dossier De Chaise	4	3		Bolts / Boulon 1/4" x 40mm	8
D		Front Leg / Pied Avant	8	4		Bolts / Boulon 1/4" x 63mm	16
				5		Bolts / Boulon 1/4" x 75mm	16
				6		Allen Key / Clé Allen 4mm	1
				7		Wood Screws / Vis # 4 x 38mm	24

### STEP 1 / ÉTAPE 1

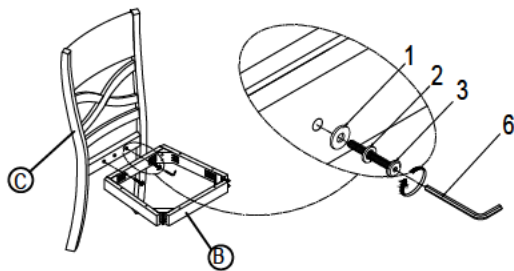

### STEP 2 / ÉTAPE 2

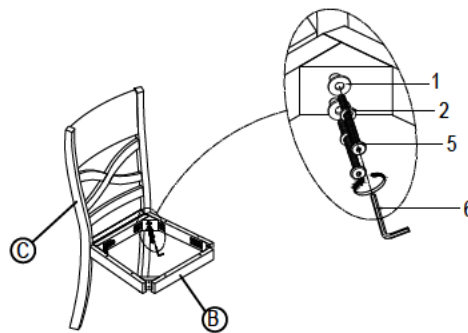

### STEP 3 / ÉTAPE 3

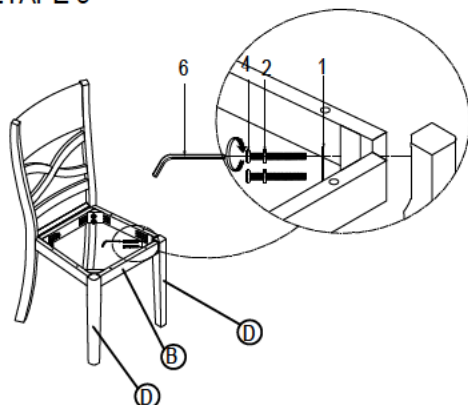

### ASSEMBLY COMPLETED / ASSEMBLAGE COMPLÉTÉ

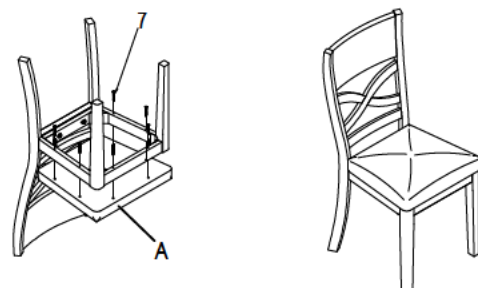

DO NOT TIGHTEN BOLTS UNTIL COMPLETELY ASSEMBLED

NE PAS SERRER LES BOULONS JUSQU'À CE QUE LE MONTAGE SOIT COMPLÈTTERMINÉ